

# SPECIFICATION GUIDE

SUPERSEDES ALL PRIOR VERSIONS

MARCH 2019



**Diamond**<sup>®</sup>  
DISTINCTION™ SERIES



# Diamond<sup>®</sup>

## DISTINCTION™ SERIES

**More than just a pretty face.™**

Welcome to 2019 and to a brand new look and feel for Diamond. With the advent of our new one brand/three series architecture we decided now was the perfect time to put a new face with our name.

True beauty is more than skin deep. The Diamond<sup>®</sup> Distinction™ Series offers clever organization to ensure the kitchens you design are as smart as they are stylish. From the most mouth-watering color and oh-so-stylish storage options to the well-executed basics, you can trust Diamond to deliver the design flexibility you want, the price breadth you need and the service you deserve in one complete brand experience.

From all of us to all of you, warm wishes for a prosperous and fulfilling 2019. We can't wait to see what you create!

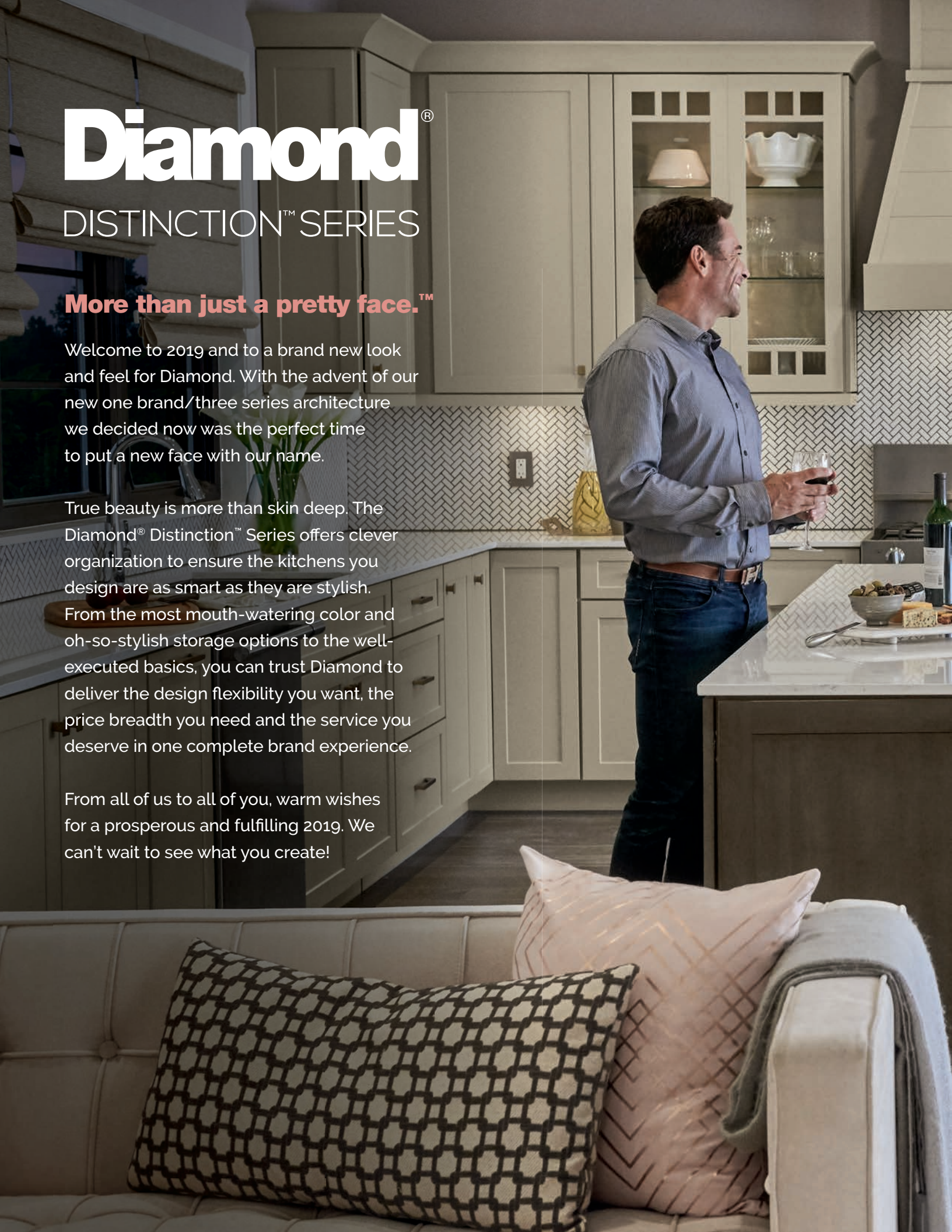





SATIN SHEEN

NEW MATTE SHEEN





**NEW**

## MATTE SHEEN

From lipstick to home goods to appliances, matte finishes are showing up everywhere, and our cabinets are no exception. Available on any stain, any species and offered at the same price as our current Satin sheen, our new Matte sheen top coat absorbs more light for a softer, more natural appearance.



## SATIN SHEEN

Our original top coat features a moderate sheen which is reflective without being too glossy for a timeless, subtle effect. Available on all stains, glazed stains, paints and glazed paints.





SHILOH MAPLE ICY AVALANCHE

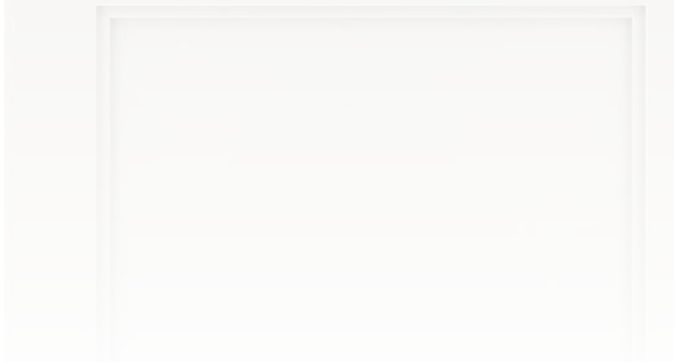

SELENA MAPLE LIMESTONE

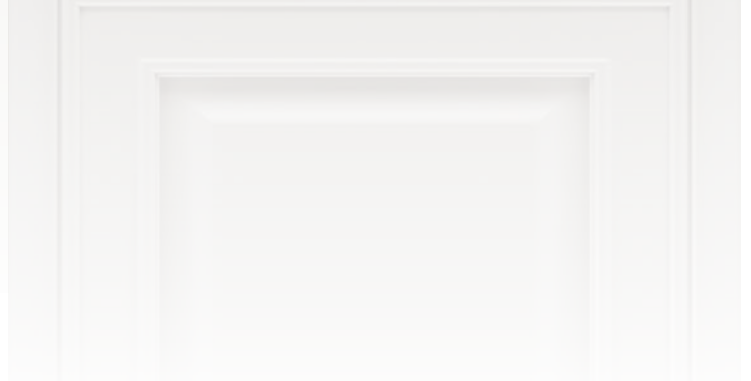



## ICY AVALANCHE

### SPEC GUIDE PAGE 27

As a designer, you know that one white option is never enough. Warm or cool, white is defined by the rest of the colors in a room. Diamond adds to your arsenal of color with Icy Avalanche - a beautiful white paint featuring warm gray undertones.

Available on Maple\* and with all glazes.  
Available on MDF - Summer 2019



**ICY AVALANCHE**

---

## LIMESTONE

### SPEC GUIDE PAGE 27

Continuing to build our offering of timeless neutrals, Diamond brings a light, warm greige to the palette. Limestone paint pairs beautifully with wood stains and other paints, and is right in line with today's most popular choices in countertop and flooring.

Available on Maple\* and with all glazes.  
Available on MDF - Summer 2019



**LIMESTONE**

\* The door and/or drawer front center panel on painted Maple door styles and may be constructed of Medium Density Fiberboard (MDF).







## PAINTED MDF (AVAILABLE SUMMER 2019)

### SPEC GUIDE PAGE 31

For customers in search of a lower cost paint alternative with better resistance to warping, expansion and contraction, we offer a new MDF substrate option. All current paint colors will be available on these 4 door styles.

MONTGOMERY



CALDERA



BREMAN



TRYSTAN



### PAINTS

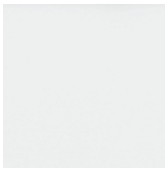

White

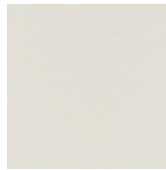

Icy Avalanche



Dover

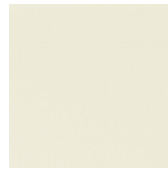

Coconut



Egret



Limestone



Lambswool



Juniper Berry

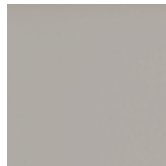

Cloud



Seaside



Moonstone



Maritime



Black

# QUICK-RELEASE™ HINGE

## SPEC GUIDE PAGE 37

Announcing the Diamond Quick-Release™ fully concealed, 6-way adjustable cup hinge featuring Smart Stop™ self-closing innovation and deactivation option. This new hinge features a push tab which allows quick and easy tool-less removal of doors without removing the screw that attaches it to the face frame.



# MATCHING LAMINATE ENDS EXPANSION

## SPEC GUIDE PAGE 29-34

Automatic matching laminate ends on Seal and Maple Storm stains as well as Maritime paint means fewer opportunities for error, a more streamlined ordering process, and reduced installation time in the field.



**SEAL**  
Available in all species

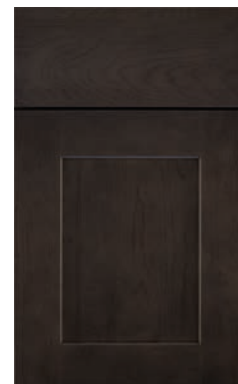

**STORM**  
Maple



**MARITIME**  
Maple and MDF



## BIOMETRIC SECURED DRAWER

### DRWSEC\_ SPEC GUIDE PAGE 49

This modification upgrades a standard drawer with an installed self-locking mechanism featuring proven Master Lock advanced sensor biometric technology. This industry-leading innovation deters would-be thieves and curious hands from accessing valuables and articles needing to be secured. Advanced sensor technology sees past contaminants and imperfections to assure fast, accurate scans granting or restricting access with the touch of a finger.

- Available on 18", 21" and 24" wide base cabinets measuring 24" deep
- No keys or codes required
- Manual back-up access
- Stores up to 100 fingerprints

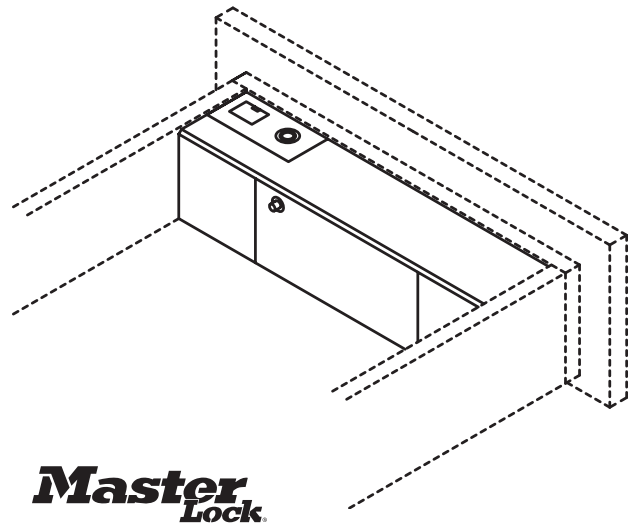

## EZ-ORG™ MODULAR PULL-OUT RACKS

### EZORG\_ \_ SPEC GUIDE PAGE 577

Available as an accessory for 18" and 24" wide and wider wall cabinets, this modular solution mounts to the floor of a wall cabinet, offering racks that pull out individually for full visibility and accessibility to contents.

- Installs as one unit
- Full extension guides
- Natural finish wood shelves with wire racks; frosted front and back panels

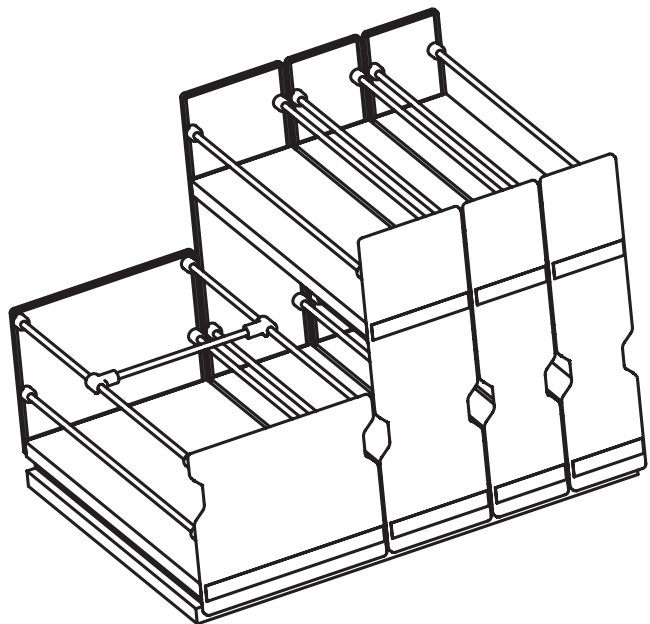

# BLIND CORNER SINK BASE

## SBC\_ \_ L OR R SPEC GUIDE PAGE 284

When space is at a premium or when your customer desires a second sink, look to the new Blind Corner Sink Base cabinet for the maximum in corner efficiency. With a considerably larger opening than traditional blind corner cabinets, accessibility is no longer a problem.

- Available in a left or right configuration
- 51", 54", 57", 60" and 63" widths

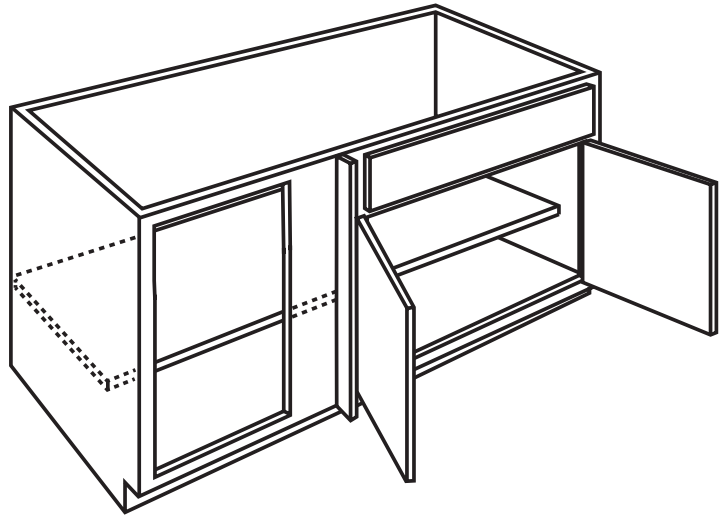

# MOULDINGS

## SPEC GUIDE PAGES 534, 537, 539

We've updated our mouldings, making it easier to personalize your designs. New Under Panel Moulding is an easy solution to conceal a raw edge on a 1/4" thick panel skin. Available in Specialty Laminate finishes (UPM8P) and Cherry and Maple (UPM8).

Light Baffle (LB2P) and Starter Shaker Premium (STRS8P) mouldings are now available in Specialty Laminate finishes to enhance your designs using Wixom, Tranter, Graniti and Worthen door styles.

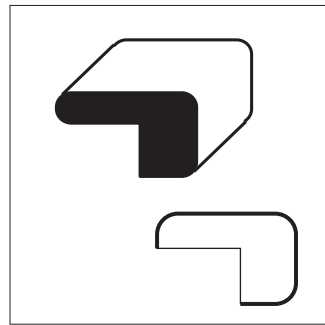

UNDER PANEL  
MOULDING, **UPM8**

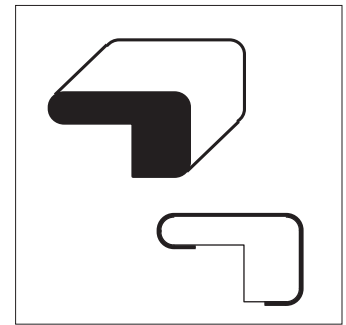

UNDER PANEL PREMIUM  
MOULDING, **UPM8P**

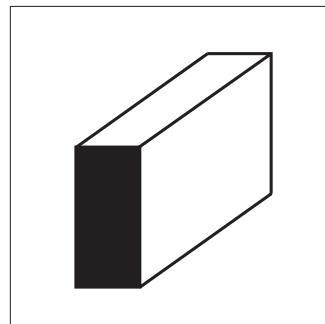

LIGHT BAFFLE  
MOULDING PREMIUM,  
**LB2P**

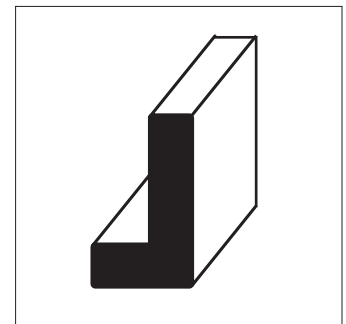

STARTER MOULDING  
SHAKER PREMIUM,  
**STRS8P**



## TAPERED WOOD HOOD, 36" WIDE

### TWH36FW SPEC GUIDE PAGE 214

This redesigned construction replaces bulky flanking fillers with a true 36" wide solution for a more cohesive appearance.

- Available in Alder, Cherry, Hickory, Maple, and Oak

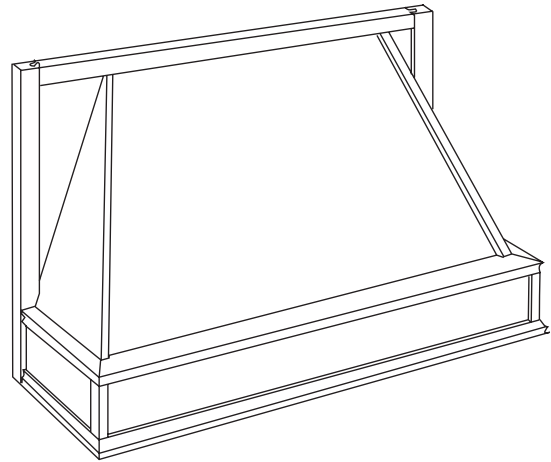

## BASE CORNER WITH CURVED PULL-OUT

### BCFW48CPO L OR R SPEC GUIDE PAGE 288

The pull-out in this improved design now features Smart Stop™ technology and a design that pulls straight out, minimizing obstructions for its use.

- Includes two pull-out shelves with chrome wire surround and Smart Stop™
- Shelf pulls forward only and can therefore be installed next to a wall or appliance without interference

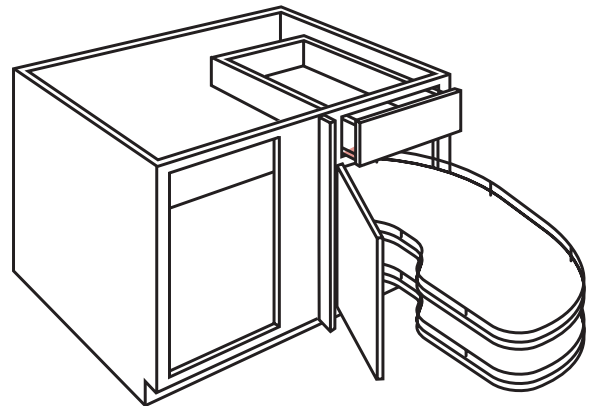

## COUNTRY SINK BASE WITH SHORT APRON

### CNTYSB\_ \_ SA SPEC GUIDE PAGE 282

Our new Country Sink Base cabinet features taller doors and a shorter trimmable apron panel for a pleasing aesthetic on more shallow sink applications.

- 10½" high panel can be trimmed up to 9"
- 30", 33", 36", and 39" wide

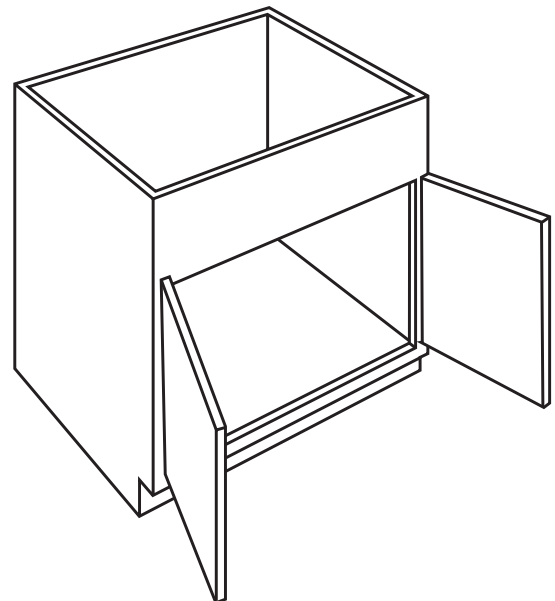

## TOEKICK VACUUM

### TOEKICKVAC SPEC GUIDE PAGE 577

Available as an accessory only, our newest toekick vacuum solution features a slimmer profile, reusable bag and HEPA filter.

---

This new version replaces the previous CABVAC accessory and VACTK, VACL, and VACR modifications.

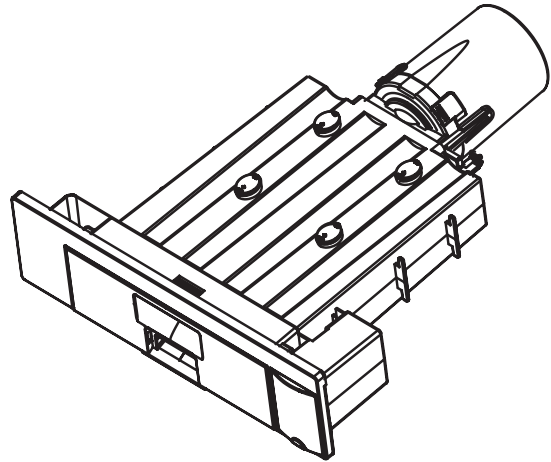

## MFO OPTION ON WIXOM, TRANTER AND GRANITI

### SPEC GUIDE PAGE 41

Wixom, Tranter and Graniti are now available with the Modified Full Overlay option, making it easier to apply face mounted crown moulding.

## STAIN AND PAINT QUARTS

### SPEC GUIDE PAGE 583

To make ordering easier, all quarts of touch-up stain and paint can be ordered with the same SKU: QUARTCOLOR.

## SINGLE PANEL CUSTOM DOOR WIDTH INCREASE

### SPEC GUIDE PAGE 514, 517

By increasing the width of our custom doors not requiring a center stile, larger appliance panels blend in more seamlessly as they take on the appearance of a standard cabinet door. The maximum width has increased from 23 3/4" to 25 7/8" wide. Custom hinged doors are available up to 24" wide, previously limited to 23 3/4" wide.

## DISCONTINUATIONS

Forest Floor and Pearl Paint

Base Buffet Cabinets: B30B, B33B, B36B, B30TRB, B33RTB, B36RTB

Diagonal Base with Lazy Susan (Plastic): DAB36 L or R

Toekick Vacuum Modification: VACTK, VACL, VACR

Toekick Vacuum Accessory: CABVAC (replaced with new TOEKICKVAC)

CPU Base: CPU12\_ \_ , CPU15\_ \_

Mouldings: IVYM, SR8, CORNERPOST

Panels: BEPS\_ \_LAM18, TEPS\_ \_LAM18, WEPS\_ \_LAM18



**TABLE OF CONTENTS**

Index by Description ..... A-E

Characteristics ..... 1-3

12-Step Finishing Process ..... 4

Humidification ..... 5

Door Styles ..... 6-25

Premium Color Palette ..... 26

Unfinished ..... 27

Finish Techniques ..... 27

Finish Availability Chart ..... 28-34

Specifications ..... 35

Construction Features ..... 36

Modification/Upgrade Compatibility Chart ..... 37

Construction Upgrades ..... 38

Drawer Front Upgrades ..... 39

Drawer and Door Options ..... 40

Custom Modifications ..... 41-56

Door Modification/Specialty Doors ..... 57-61

Glass Inserts ..... 62-71

Cabinet Dimensions ..... 72-79

Design Checklist ..... 80

NKBA Guidelines ..... 81-82

Logix® Reference Chart ..... 83-84

Wall Cabinets ..... 85-165

Hearths ..... 166-175

Base Cabinets ..... 176-252

Universal Design Cabinets ..... 253-258

Tall Cabinets ..... 259-298

Office & Furniture Cabinets ..... 299-313

Vanity Cabinets ..... 314-348

Fillers ..... 349-358

Wainscoting ..... 359

Custom Hinged Doors ..... 360-361

Decorative Appliance Panels ..... 362-364

Panels & Skins ..... 365-375

Moulding ..... 376-387

Valances ..... 388

Embellishments ..... 389-412

Contemporary Embellishments ..... 413

Lighting & Lighting Accessories ..... 414-415

Decorative Hardware ..... 416

Accessories ..... 417-425

Roll Tray Kits ..... 426-428

Guide Kits and Parts ..... 428

Stain, Paint, & Touch-up Tools ..... 429

Hinges ..... 429-430

Parts ..... 430

Stacked Moulding Kits ..... 431-439

Agreements ..... 440-442

Index by Code ..... 443-444

Description	Code	Page Number
Abbe Foot	ABFOOT	403
Acanthus Foot	JACANFOOT	404
Acanthus Insert	JACANINSERTM	380
Acanthus Leg	JACANTHUSLEG	391
Acanthus Light Rail Insert	JLRINSACAN	386
Acanthus Moulding	ACAM	381
Acanthus Ornament	ACO	389
Acanthus Overlay	ACOVLY	389
Acanthus Tile	JTILEACAN	391
Add Toekick	ADDTK	52
All-plywood Construction	APC	38
Aluminium Frame Doors w/Frost Glass	ALF	57
Angled Corner Sink Front Bottoms	ACSF	211
Angled Corner Sink Fronts	ACSF	211
Angled Corner Sinks	ACS	210
Angled Fluted/Plain Fillers	BLVDFD	354
Appliance Cut-out, Single	ACS	46
Arched Valance	AV	388
Art Corbel 9"	CORBELART9	408
Arts & Crafts Bracket	JBRACKETART	411
Arts & Crafts Open Corbel	JCORBELARTO	411
Asymmetrical Base Easy Reach	BER	221
Asymmetrical Base Easy Reach w/Adjustable Shelves	BERAS	221
Asymmetrical Easy Reach Wall Corners	ER	130
Asymmetrical Solid-wood Super Lazy Susan	SLSW	224
Asymmetrical Super Lazy Susan w/Chrome Rail	SLSR	225
Asymmetrical Super Susans	SLS	224
Authentic Ends	AUTHL, AUTHR	41
Back Panel Moulding	BPM	381
Back Skin, Interior	BP	366
Back Sockets	BKSOCKET	428
Bar Leg	BARLEG	391
Baroque Leg	JBAROQUELEG	392
Base Bin Tray Pull-out Cabinets	BBTP	239
Base Box Column Pull-outs (Plain, Overlay)	BBPO	244
Base Buffet Three Drawer	3DBB	232
Base Buffet Three Drawer w/Deep Drawer	3DBBDD	235
Base Built-In Microwave Cabinet w/Drawer	BBMWD	246
Base Cabinets	B	176-256
Base Cabinets Four Drawer	4DB	235
Base Cabinets Four Drawer w/Cutlery Insert Wood Organizer	4DB..WTCD	236
Base Cabinets Four Drawer w/Wood Tiered Cutlery Divider Drawer	4DB..WTCD	236
Base Cabinets Four Drawer w/Wood Tiered K-Cup Drawer	4DB..KCUP	237
Base Cabinets Full Width w/Roll Trays & Swing-outs	BCFW..SP	218
Base Cabinets Three Drawer	3DB	232
Base Cabinets Three Drawer Corner	3CDB	226
Base Cabinets Three Drawer w/Deep Drawer	3DBDD	234
Base Cabinets Three Drawer w/Warming Drawer	3DB..WD	234
Base Cabinets Three Drawer w/Wood Tiered Cutlery Divider Drawer	3DB..WTCD	233
Base Cabinets Three Drawer w/Wood Tiered K-Cup Drawer	3DB..KCUP	233
Base Cabinets Two Drawer	2DB	229
Base Cabinets Two Drawer w/Drop-in Range	2DB..DR	231
Base Cabinets Two Drawer w/Drop-in Range & Warming Drawer	2DB..WD	231
Base Cabinets Two Drawer w/File Drawer	2DB..FD	229
Base Cabinets Two Drawer w/Pegged Dish Organizer	2DB..PDO	230
Base Cabinets Two Drawer w/Roll Tray	2DB..RT	230
Base Cabinets Two Drawer w/Roll Tray & Pegged Dish Organizer	2DB..RTPDO	231
Base Cabinets w/Full Height Doors	B..FH	180, 182
Base Cabinets w/Mixer Shelf	B..FHMIXSC	199
Base Container Organizer Pantry Pull-out	BCOPP	243

Description	Code	Page Number
Base Corner Cabinets	BC	215
Base Corner Cabinets w/Pull-out	BC..PO	216
Base Corner Full Width Cabinets	BCFW	216
Base Corner Full Width Cabinets w/Curved Pull-out	BCFW..CPO	217
Base Corner Full Width Cabinets w/Pull-out	BCFW..PO	217
Base Corner Inside	B..CIA	228
Base Corner Outside	B..COA	227
Base Corner Peninsula	BCP	249
Base Corner Peninsula, Full Height Door	BCP..FH	249
Base Drawer Cabinets	DB	228-236
Base Drop-in Range Cabinet	B..DR	245
Base Easy Access Cabinets	BEAS	183
Base Easy Reach	BER	220
Base Easy Reach w/Adjustable Shelves	BERAS	220
Base End Cabinet	BEC	228
Base End Shelves	BQRES	250
Base Full Height w/Tray Divider	TD..FH	199
Base Lazy Susan Corner w/Center Hinge Door	BLS	219
Base Lazy Susan Corner w/Revolving Door	BLS..DR	218
Base Message Center	BMC	245
Base Microwave Cabinets	BMW	248
Base Microwave Cabinets w/Deep Drawer	BMWDD	247
Base Microwave Cabinets w/Drawer	BMW	247
Base Microwave Cabinets w/Roll Tray	BMW..RT	248
Base Mixer Kit	MIXKITFHSC	417
Base Open Cabinets	BOC	250
Base Open Cabinets w/Drawer	BOD	251
Base Ovens	BO	246
Base Pan Storage	BPS	417
Base Panel w/Filler Attached & Authentic End	BEP..AEL, AER	372
Base Pantry Pull-outs	BPP	243
Base Paper Towel Cabinet	BPT	177
Base Paper Towel Cabinet Full Height	BPT..FH	180
Base Paper Towel Cabinet w/Wastebasket	BPT..WB	238
Base Paper Towel Cabinet w/Wastebasket Full Height	BPT..WBFH	239
Base Pots & Pans Pull-out	BPPP	194
Base Rotating Deep Bin	BRDB	225
Base Spice Drawer	BSD	241
Base Transition Cabinets	BTC	227
Base Utensil Pantry Pull-out	BUPP	243
Base Utensil Pantry Pull-out w/Knife Block	BUPPKB	244
Base Wastebasket	BWB	237
Base Wastebasket Full Height	BWB..FH	238
Base Wastebasket Lids	BWBFHLID, BWBLID	417
Base Wine Cubby	BWC	241
Base w/Can and Wine Bottle Pull-outs	B..CWP	196
Base w/Food Storage Container Organizer	B..FSCO	195
Baseboard Moulding	BBM	383
Baseboard - Sculpted	BBMSC	384
Baseboard - Shaker	BBMSH	384
Baseboard - Swooped	BBMSW	384
Bases w/Cutlery Insert	B..CIW	178
Bases w/Drawer & Lid Organizer & Roll Trays	B..RTLO	193
Bases w/Full Height Doors & Roll Trays	B..FHRT	189
Bases w/Lid Organizer & Roll Trays	B..FHRTLO	193
Bases w/Roll Trays	B..RT	188
Bases w/Roll-out Tray Divider	B..TDRO	198
Bases w/Tray Dividers	TD	198
Bases w/Wood Cutlery Insert & Roll Trays	B..RTCIW	191
Bases w/Wood Tiered Cutlery Divider Drawer	B..WTCD	178
Bases w/Wood Tiered Cutlery Divider Drawer & Roll Trays	B..RTWTCD	192
Bases w/Wood Tiered K-Cup Drawer	B..KCUP	179
Bases w/Wood Tiered K-Cup Drawer & Roll Trays	B..KCUPRT	192
Biometric Secured Drawer	DRWSEC	48
Bookcases Tall	TBC	302-303
Bookcases Tall w/Doors	TBCD	304-305



Description	Code	Page Number
Bookcases Wall Furniture	WFBC	300
Box Column Fillers (Wall, Base, Tall)	BCF	354-356
Braided Moulding	BRAIDM	380
Broom Clip	BRMCLP	417
Buffet Leg	JBUFFTELEG	392
Bumper Pads	BUMPERPADS	430
Cabinet Box Only	CBO	43
Cabinet Case Only	CCO	43
Cabinet False Panel	CFP	43
Cabinet Frame Only	CFRMO	56
Cabinet Front Only	CFNTO	56
Cabinet Panel Edge Moulding	CPE	381
Cabinet w/No Door, w/Drawer	CND	43
CabMat™	CABMAT	417
CabMat™	CMAT	48
CabMat™ Vanity	CABMATV	417
Cap Moulding	CAPM	385
Celtic Corbel	CORBELCELT	408
Celtic Insert	INSERTCELT	380
Celtic Light Rail Insert	JLRINSCFLT	386
Celtic Overlay	JCELOVLY	389
Celtic Rosette	ROSETTCELT	390
Classic Fluted Leg	JFLUTELEG	394
Classic Fluted Leg, Small	JFLUTELEGS	394
Classic Fluted Leg, Small Split	JFLUTELEGSS	394
Classic Rope Leg	JROPELEG	399
Classic Rope Leg, Small	JROPELEGS	399
Classic Rope Leg, Small Split	JROPELEGSS	399
Classic Tall Crown Moulding	CLTCROWN	376
Contemporary Light Rail	JINSERTLRC	386
Cooking Utensil Divider	CUDD	418
Corner Door Cabinets	CD	144
Corner Fillers	CF	349
Corner Tambour Cabinets	CT	143
Cornice Tall Crown Moulding	COTCROWN	376
Cosmo Corbel, 7" Small	JCORBELCOS7	408
Cosmo Corbel, 13" Large	JCORBELCOS13	409
Cosmo Corbel, 13" Large Deep	JCORBELCOS13D	409
Cosmo Foot	JCOSFOOT	404
Cosmo Leg	JCOSMOLEG	392
Countertop Edge Moulding (Contemporary & Traditional)	CCM, TCM	381
Country Sink Base w/CabMat™	CNTYSB..CM	212
Country Sink Base w/Short Apron	CNTYSB..SA	213
Country Sink Bases	CNTYSB	212
Cove Corbel	CORBELCOVE	409
Cove Crown Moulding	COVECROWN	376
Craftsman Foot	JCRAFTFOOT	404
Craftsman Open Bracket	JCORBELCRAFTO	411
Crescent Metal Corbel	CORBELCRBN	413
Cross Grain Veneer Back Skin 1/4" Panels	BP..CRSGR	367
Custom Doors w/Hinge Routing	DOOR	360
Custom Doors w/Hinge Routing, Slab Styles	DOORSLAB	361
Cut-for-glass Doors	CG, CG.BTM, CG.TOP	58
Cutlery Dividers	CIW, WTCD	418
Decorative Appliance Panels	DAPNL	362
Decorative Door Panel Kits, Base End	BED	374
Decorative Door Panel Kits, Tall End	TED	375
Decorative Door Panel Kits, Wall End	WED	375
Decorative Split Turnings 3"	J3SPTRING	407
Decorative Split Turning End	SPTRINGEND	407
Decorative Split Turning Reed	SPTRINGREED	407
Decorative Split Turning Rope	SPTRINGROPE	407
Decorative Split Turning Spool	SPTRINGSPOOL	407
Deep Roll Tray	DRT	49
Dentil Moulding	MDENTIL	380
Desk Door Drawer Bases	DDO	306
Desk Double File Drawer Bases	DDFD	308

Description	Code	Page Number
Desk Drawer Bases	DDR	307
Desk Easy Reach	DER	309
Desk File Drawer Bases	DFD	307
Desk Wastebasket Full Height Bases	DWB..FH	308
Diagonal Base Cabinet w/Full Height Door	DAB..FS	219
Diagonal Base Cabinet w/Full Height Door & Super Lazy Susan	DAB..SLS	219
Diagonal Corner Moulding	DCM	386
Diagonal Wall Cabinets	DW	122-124
Diagonal Wall Cabinets w/Lazy Susan	DW..S	123
Diagonal Wall Cabinets w/Lower Door	DW..D	124
Diagonal Wall Cabinets w/Lower Door & Lazy Susan	DW..DS	126
Diagonal Wall Cabinets w/Tambour	DW..T	124
Diagonal Wall Cabinets w/Tambour & Lazy Susan	DW..TS	126
Diagonal Wall Peninsula Cabinets	DW..P	128
Door Panel - Solid Reverse Raised	DPSRR	40
Drawer Front Flat 5-Piece	DF5PC	39
Drawer Front Raised 5-Piece	DFR5PC	39
Drawer Front Slab	DFSLB	39
Drawer Guide Kits	DGK	428
Drawer Guide Spacer Block	SPACERBLK	428
Dutchless Conversion Kit	CONVERSION	165
Easy Reach Wall Corner Cabinets	ER	129
EasyTrax™	ET	49
Edgebanding	EDGEBAND	419
Egg & Dart Moulding	EGD	380
End Extended Back	EXBKL, EXBKR	45
End Panel/Base	BEP	368
End Panel/Base Lazy Susan	BLSBEP	369
End Panel/Tall	TEP	369
End Panel/Vanity Base	VBEP	370
End Panel Skins/Base	BEPS	365
End Panel Skins/Tall	TEPS	365
End Panel Skins/Wall	WEPS	366
English Bar Column	ENGBARCOLUMN	393
English Country Leg	JENGCNTYLEG	392
English Island Column	ENGISLCOLUMN	393
Estate Leg	JESTATELEG	394
Estate Leg, Small	JESTATELEGS	393
Estate Leg, Small Split	JESTATELEGSS	393
Extended Stile	EXL, EXR	46
Exterior Shelves	ES	419
EZ-Org™ Modular Pull-out Racks	EZORG	423
Face Frame and Door on End	FFDL, FFDR	41
False Panel Clips	FALSEPNLCLIP50, PFALSEPNLCLIP50	428
Filler Return	F..R	349
Fillers	F, TF	349
Finger Pull	PULLH	413, 416
Finished Back Skins	BP	366
Finished Ends	FB	41
Flat Scribe Moulding	SM	381
Floating Island Bases	FIC	242
Floating Island Bases without Top	FICNT	242
Floating Shelves	FS	156
Flush Toekick	FTK, FTK.FNT.P, FTK.P	52
Flush Toekick Arch	FTKAV, FTKAV.FNT.P, FTKAV.P	52
Flush Toekick Furniture	FTKFV, FTKFV.FNT.P, FTKFV.P	52
Fluted/Beaded Fillers	FBF	354
French Country Foot	JFRNCNTYFOOT	404
French Country Leg	JFRNCNTYLEG	395
French Leg	FRNLG	404
Full Depth Shelf	FD	48
Full Depth Shelving	SK	420
Full Overlay Crown	FOLCROWN	376

Description	Code	Page Number
Furniture Drawer Window Bench	FDWB	311
Furniture Drawers	FD	310
Furniture Finished Plywood Ends	FPEB	41
Furniture Valance	FV	388
Glass Shelf Kits	JGSK	420
Hardware Decorative Pulls and Knobs	KNOBH, PULLH	416
Hearth Liner	HL	175
Hearth Mantels	HM	173-174
Hearth Piers	HP.21	171
Hearth Piers w/Pull-out	HPP.21	172
Hearth Shelf	HS	175
Heat Shields	ANGLHEATSHIELD, ANGLHSHIELDSS, STRTHEATSHIELD, STRTHSHIELDSS	421
Hinge Angle Restriction Clip	HINGERESCLIP, RESCLIPQR	429
Hinge Shim	HINGESHIM	430
Hinges	HINGE	416
Increased Depth	ID	44
Insert Crown	INSCROWN	376
Inside Corner Moulding	ICM	387
Installed Roll Tray	RT	49
Inverted Frame	INVFRM	47
Island Leg	ISLLEG	396
K-Cup Insert	WBCPOKUP	421
Large Corbel	LGCORBEL	408
Large Outside Corner Moulding	LOSC	387
Large Shaker Crown	LSHAKER	377
Large Square Foot	LGSQFOOT	405
Large Straight Angle Crown Moulding	LSACROWN	377
Lazy Susan Pull-out	LSP	226
Library Moulding	LBRM	382
Lid Organizers	LO, LO24DP	421
Lidstay	LIDSTAY, LIDSTAYHD	430
Light Baffle Moulding	LB	385
Light Installed Battery Strip	LTI	49
Light Rail Moulding	LRM	385
Lighting & Lighting Accessories	—	414-415
Lille Foot	LIFOOT	405
Linen Closet	LC	341
Linen Closet Hamper Liner	LCHAMPERLNR	421
Linen Closet w/Removable Hamper	LCRH	342
Linen Storage Cabinets	LT	342
Loose Toekick	TKP	54
Madeline Foot	JMADEFOOT	404
Madison Foot	JMADFOOT	404
Matching Interior Plywood	MIP	42
Medicine Cabinets (Single & Tri-View)	MC, TV	348
Medium Straight Angle Crown Moulding	MSACROWN	377
Metal Feet	FOOTMETAL	413
Metro Bar Column	METBARCOLUMN	396
Metro Island Column	METISLCOLUMN	397
Metropolitan Foot	JMETROFOOT	405
Mirror Frame Moulding	WMF	382
Miscellaneous Parts	BRKOFFSCREW, BUMPERPADS, INSTALLSCR, INSTALLSCREWS, MC16HDW/WCATCH, PDM, RETCLIP.BAG, SHELFPEGS, SHELFPEGSCTR, TVHDW/WCATCH	430
Mission Corbel 6"	CORBELMIS6	409
Mission Corbel 9"	CORBELMIS9	409
Mission Insert	JMISINSERTM	380

Description	Code	Page Number
Mission Leg	DLEGMSSION	397
Mission Light Rail Insert	JLRINSMIS	386
Mission Rosette	ROSETTEMIS	389
Mission Tile	JTILEMISSION	391
Modified Full Overlay	MFO	40
Mullion Doors	MD, MD.BTM, MD.TOP	59
Mullion Doors, Prairie	PRMD	61
Mullion Doors, Shaker	SHMD	60
Ogee Edge Moulding	OGEEM	382
Old World Corbel 4"	JCORBELOWD4	410
Old World Corbel 5"	CORBELOWD5	410
Old World Corbel 7"	JCORBELOWD7	410
Outside Corner 135° Moulding	OC135	387
Outside Corner Moulding	OCM	387
Oven Cabinets Double	OCD	287-288
Oven Cabinets Double w/Drawer	OCD..DD, WD	289-291
Oven Cabinets Double w/Drawer & Extended Opening	OCD..WDE	292
Oven Cabinets Single	OCS	282-283
Oven Cabinets Single w/Drawer	OCS..DD, WD	284-286
Oven Installation Kit	OCINSTALLKIT	422
Oven Microwave Cabinets	OMC	294-295
Oven Microwave Cabinets w/Drawer	OMC..DD, WD	296-298
Overlay Fillers	OL	350
Overlay Fillers for Modified Full Overlay	OL.MFO	350
Panels w/Filler Attached	BEPF, TEP, WEP	371-373
Pantry Top Units	PTU	275
Pantry Top Units w/Pull-out	PTUP	276
Pantry Top Units w/Shelves	PTUS	274
Pantry Units	PY	279
Pantry Walk-Through	PWT	281
Pegged Dish Organizer	PDO, PDOPOSTS	422
Peninsula	P	56
Plinth Block	PLBLOCK	406
Plinth Block Filler 3"	FPF, BFPC	390
Plinth Block Filler 6"	FPF	391
Plywood Ends	PE	38
Pots & Pans Organizer Bases w/Drawer	B..PS	194
Pots & Pans Pull-out	PPP	422
Power Pods	JPWRPOD	422
PowerGlide™ Compact Drawer Outlet	DRWPWR	50, 422
Prepare Cabinet for Finished Bottom	PFINBTMB	45
Printer Bases	PRB	309
Push to Open Wastebasket	PTOWB	50
Quarter Round Moulding	QRM	387
Quattro Dimming Receiver	QDIMREC	415
Quattro Wall Controller	Q4ZONECON	415
Queen Anne Leg	JQUNANNELEG	397
Raised Panel Arch Valance	JRPV	388
Recessed Island Toekick	RECTKALL	54
Recessed Panel Arch Valance	JRPCV	388
Recessed Toekick on Back or Side	RECTKBK, RECTKL, RECTKR	54
Reduced Depth	RD	44
Reed Leg	JRDLEG, RDLEG	397
Removable Vanity Sink Base	RVWS	255
Roll Tray Kits	RT	426
Roll Tray Kits Deep	DRT	426
Roll Tray Plug In Bracket	RTBKXSP	428
Roman Weave Leg	JWEAVELEG	398
Rope Moulding	RPM	380
Rosette (Traditional)	TROSETTE	389
Rosette 3"	FFRC, BFRC	390
Rosette 6"	FFRC	390
Scalloped Valance	SV	388
Scooped Drawer	SCPDRW	40
Scroll Corbel 6"	CORBELSCR6	410
Scroll Corbel 9"	CORBELSCR9	410
Scroll Rosette	ROSETTESCR	389



Description	Code	Page Number
Segmented Super Susan	SSS	222
Shaker Corbels	JCORBELSHKR	411
Shaker Crown Moulding	SHKRCRM	377
Shelf Pull-down	SHLFPD	423
Shelf Support Bracket	SHELFBRKTSN	413
Shoe Moulding—Convex Inside Corner	SHM	387
Single Bead Edge Moulding	SBE	382
Single Bead Moulding	SBM	382
Single Bead Pilaster	SBP	382
Single Door Medicine Cabinet	MC	348
Single Outlet Cover	JSOC	412
Single Rocker Plate	JSRC	412
Sink Base Blind Corner	SBC	214
Sink Base Caddy	SBCADDY	422
Sink Base SuperCabinet™	SB..S	206
Sink Base SuperCabinet™ w/CabMat™	SB..SCM	206
Sink Base SuperCabinet™ w/Caddy	SB..SCDY	207
Sink Base SuperCabinet™ w/Tilt-out Trays	SB..STS	207
Sink Base SuperCabinet™ w/Tilt-out Trays & CabMat™	SB..STSCM	208
Sink Base SuperCabinet™ w/Tilt-out Trays & Caddy	SB..STSCDY	208
Sink Base w/CabMat™	SB..CM	201
Sink Base w/Caddy	SB..CDY	201
Sink Base w/Tilt-out Trays & CabMat™	SB..STCM	204
Sink Base w/Tilt-out Trays & Caddy	SB..STCDY	204
Sink Bases	SB	200-203
Sink Bases w/Drawers Below	SB..D	209
Sink Bases w/Tilt-out Trays	SB..ST, SB..CSST	203, 205
Sink Front Bottoms	SFB	209
Sliding Towel Rack	STR	423
Small Corbel	SMCORBEL	408
Small Cove Crown Moulding	SMCOVECROWN	378
Small Crown Moulding	SCM	378
Small Light Rail Moulding	SMLR	385
Small Scribe Moulding	SSM	382
Snack Bar Support	SBS	410
Soffit Filler Moulding	SFM	379
Soffit Trim Moulding	TSTM	383
Solid-wood Crown Moulding	SWCRM	378
Solid-wood Large Crown Moulding	SWLCRM	378
Solid-wood Super Lazy Susan	SLSW	223
Solid-wood Tall Crown Moulding	SWTCRM	379
Solid-wood Victorian Crown Moulding	SWVCRM	379
Space Fillers	S96	350
Special Size Vanity	MV	340
Spice Rack Pull-down	SPD	423
Spice Racks	SRCH	423
Spool Decorative Leg	SPLEG	401
Spool Leg	JSPLEGT	401
Spool Leg, Small	JSPLEGS	400
Spool Leg, Small Split	JSPLEGSS	400
Square Bar Leg	JSQBARLEG	402
Square Bar Leg, Split	JSQBARLEG3S	402
Square Corner Sinks	CS	210
Square Foot	JSQFOOT	405
Square Foot, Split	JSQFOOTS	405
Square Island Leg	JSQISLEG	402
Square Island Leg, Split	JSQISLEG3S	401
Stacked Diagonal Wall Cabinets	STDW	127
Stacked Wall Cabinets Double Door	STW	115-116
Stacked Wall Cabinets Single Door	STW	114
Stacked Wall End Cabinets Double Door	STWEC..D	134
Stacked Wall End Cabinets Single Door	STWEC	133
Stacked Wall Transition Cabinets	STWTC	138
Stain & Paint	QUARTCOLOR, SSC	429
Starter Moulding	STR8	379
Starter Moulding, Shaker	STRS	379

Description	Code	Page Number
Straight Angle Crown Moulding	SACROWN	377
Straight Tambour Cabinets	ST	142
Straight Valance	VV	388
Super Susans	SLS	222
Super Susans w/Chrome Rail	SLSCR	223
SuperCabinet™, 30"	BSC30PR, R, RP, RS, SR	184
SuperCabinet™, 36"	BSC36PRP, PRS, SRP, SRS	186
SuperCabinet™ Gourmet	BSCG	185, 187
SuperCabinet™ Version 2, 30"	BV2SC30PR, RP, RS, SR	185
SuperCabinet™ Version 2, 36"	BV2SC36PRP, PRS, SRP, SRS	187
Super Lazy Susans w/Chrome Rail	SLSCR	223
Tablet Holder	TABLEHLDR	423
Tall Built-In Microwave Cabinet	TBMWB	293
Tall Crown Moulding	MTCROWN	377
Tall Panel w/Filler Attached & Authentic End	TEP..AEL, AER	373
Tall Pantry Pull-outs	TPP	276
Tapered Leg	TAPLG	406
Tapered Wood Hood Blower	TWHBLOWER	165
Tapered Wood Hoods	TWH	164
Tilt-out Trays, Plastic	TOT	423
Tilt-out Trays, Stainless Steel	TOTSS	50, 424
Tilt-out Trays, Stainless Steel Slim	TOTSSS	50, 424
Toeboards	TB	384
Toekick Cap	TKC	385
Toekick Drawer	DRWTK	55
Toekick Vacuum	TOEKICKVAC	423
Toekick Tulip Foot	TKTLFOOT	406
Touch Latch	TOUHLATCH	413
Touch-up Tools	GLAZEPEN, MTUK, TUK	429
Traditional Light Rail	JINSERTLRT	386
Traditional Open Corbel	JCORBELTRADO	412
Tray Divider, Chrome	CTDK	424
Tray Divider Kit	TDKIT	424
Tray Divider Roll-out Kit	TDRO	424
Tray Dividers	TD	51
Tray Shelves	TRAYSHLF	157
Triple Bead Edge Moulding	TBEM	383
Triple Bead Pilaster Moulding	TBP	383
Tri-View Medicine Cabinets	TV	348
Truss Metal Corbel	CORBELTRSS	413
Tulip Foot	TLFOOT	406
Tulip Leg	JTULIPLEG	402
Under Counter Drawers	UCD	313, 340
Under Panel Moulding	UPM	383
Universal Design Base Cabinets	B..UD	253
Universal Design Base Cabinets w/Roll Tray	B..RTUD	254-254
Universal Design Base Microwave Cabinets	BMW..UD	256
Universal Design Fillers	BF, TF, FR..UD	257
Universal Design Single Oven Cabinet	OC..UD	257
Universal Design Sink Base Cabinets	SB..UD	254
Universal Design Sink Base Cabinets w/Tilt-out Trays	SB..STUD	255
Universal Design Super Susan	SLS..UD	256
Universal Design Three Drawer Base Cabinets	3DB..UD	256
Universal Design Toeboards	TB8UD	258
Universal Design Vanity Desk Leg	VDLUD	258
Urn Leg	JURNLEG	403
Utility Cabinets	U	259-264
Utility Cabinets w/Roll Trays	U..RT	265-267
Utility Easy Access Cabinets	UEAS	268-271
Utility Organizer Cabinets	UOC	272
Utility Organizer Drop Zone Cabinet	UOCDZ	273
Utility Storage w/Pantry Pull-out	US	278
Utility Storage w/Pantry Pull-out and Pot and Pan Rack	US..PP	278
Valance Top Rail	TVRAV, TVRFV, TVRVV	47
Valley Forge Moulding	VFR	385

Description	Code	Page Number
Vanity Angle Corner Sink Front	VACSF	339
Vanity Angle Corner Sink Front Bottoms	VACSF B	339
Vanity Base Easy Reach	VER	323
Vanity Base Wastebasket	VBWB	326
Vanity Bases	V	314-316
Vanity Chrome Roll-out Rack	VCRR	425
Vanity Desk Legs	VDL	373
Vanity Door Drawer Bases	VB	322
Vanity Drawer Bases	VDB	324
Vanity Four Drawer Bases	4VDB	325
Vanity Grooming Pull-out	VGPO	328
Vanity Hamper	VH..FH	341
Vanity Hamper w/Drawer	VBH	341
Vanity Mirror	VM	347
Vanity Mirror w/Side Pull-outs	VMP	347
Vanity Pull-out	VP	328
Vanity Sink Bases w/False Drawer Fronts	VS B	317-318
Vanity Sink Bases w/U-Shaped Roll-out Tray	VS B.....U	319
Vanity Sink Bases w/Wastebasket	VS B.....WB	319
Vanity Sink Bases SuperCabinet™ w/Tilt-out Trays	VSSB.....ST	320
Vanity Sink Bases SuperCabinet™ w/Tilt-out Trays & Wastebasket	VSSB.....STWB	320
Vanity Sink Drawer Bases	VSD	329-334
Vanity Sink Drawer Bases w/Eight Drawers	VSD	338
Vanity Sink Drawer Bases w/Eight Drawers & False Panel	VSD..FP	338
Vanity Sink Drawer Bases w/Six Drawers	VSD	336
Vanity Sink Drawer Bases w/Six Drawers & False Panel	VSD..FP	337
Vanity Sink Three Drawer Bases	VS3D	335
Vanity Utility Cabinets	VU	343
Vanity Wall Cabinets	W	346
Vanity Wall Hung Cabinets	VWH	343
Vanity Wall Mirror Cabinets	VWM	346
Vanity Wall Sink	VWS	255
Vanity Wall Towel Bar	VWTB	345
Vanity Wastebasket	VWB	326
Void Toekick	VTK	55
Wainscoting	WAIN	359
Wall Appliance Garage Door	WAGD	142
Wall Appliance Garage Vertical-Lift Door	WAGVLD	143
Wall Base Double Door Cabinets	WB	183
Wall Base Single Door Cabinets	WB	182
Wall Box Column Pull-outs (Plain, Overlay)	WBCPO	144
Wall Box Column Pull-outs w/K-Cup (Plain, Overlay)	WBCPOK CUP	146
Wall Built-In Microwave Cabinets	WBMW	140
Wall China Display Cabinets	WCD	152
Wall China Display Cabinets w/Doors	WCD	153
Wall Corner Cabinets	WC	117-120
Wall Corner Decorative Shelf	WCS	157
Wall Corner Double Door Cabinets	WC	118-120
Wall Corner Inside	W..CIA	132
Wall Corner Outside	W..COA	131
Wall Corner Single Door Cabinets	WC	118-120
Wall Decorative Shelves	WS	157
Wall Double Door Cabinets	W	86-108
Wall Easy Access Storage Cabinets	WEAS	108
Wall End Cabinets	WEC	133
Wall Message Center	WMC	158
Wall Microwave Cabinets	MW	139
Wall Microwave Double Door Cabinets	MW	139
Wall Open Cabinets	WOC	151-152
Wall Organizers	WO	155
Wall Quarter Round End Shelves	WQRES	135-136
Wall Refrigerator Cabinets	W	103
Wall Refrigerator Pull-out	W..PO	94, 98, 101
Wall Refrigerator Vertical-Lift	WVL	93, 97

Description	Code	Page Number
Wall Shelf Pull-down	W..SHLFPD	149
Wall Single Door Cabinets	W	85-107
Wall Spice Drawers	WSD	156
Wall Spice Pull-down	W..SPD	149
Wall Spice Pull-out	WSP	148
Wall Spice Rack Cabinets	WSR	150
Wall Susan Kits	WSK	425
Wall Three Drawer Cabinets	W3D	112
Wall Top Hinge Cabinets	WTH	86-97
Wall Transition Cabinets	WTC	137
Wall Two Drawer Cabinet	W2D	109, 111
Wall Vertical-Lift	WVL	92-97
Wall Wine Cubbies	W	155
Wall Wine Racks	WNR	154
Weave Foot	JWEAVEFOOT	405
Weave Insert	JWEAVEINSERTM	381
Weave Light Rail Insert	JLRINSWEAVE	386
White Laminate Interior	WLI	42
Wide Scribe	WSCRIBE	383
Window Casing—Traditional	WCT	385
Wine Glass Holders	WGH	425
Wine Storage Cabinet	WSC	154
Wood Hood Arch	WHA	158
Wood Hood Blower	BLOWER	164
Wood Hood Canopy Arched	WHCA, JWHCA	162
Wood Hood Canopy Square	WHCS, JWHCS	162
Wood Hood Chimney	WHC	159
Wood Hood Contemporary Straight	JWHCONSTR	159
Wood Hood Island Arch	JWHIA	163
Wood Hood Island Square	JWHIS	163
Wood Hood Linear, Tapered	JWHL	160
Wood Hood Shiplap Chimney	JWHSHPCH	161
Wood Hood Shiplap, Straight	JWHSHPSTR	160
Wood Hood Shiplap, Straight w/Corbels	JWHSHPSTRCB	160
Wood Hood Shiplap, Tapered	JWHSHP T	161
Wood Hood Shiplap, Tapered w/Corbels	JWHSHP TCB	161
Wood Hood Square	WHS	159
Wood Tiered K-Cup Drawer	KCUP	419
Wood Tops, Four Sided	4TWT	313
Wood Tops, One Sided	1TWT	311
Wood Tops, Three Sided	3TWT	312
Wood V-grooved Beaded Skin 1/4" Panels	BP..VG	367
Wood V-grooved w/Triple Beaded Front 3/4" Panels (Base, Tall, Wall)	BEP, TEP, WEP..VG	374

## CHARACTERISTICS OF WOOD TYPES

No matter which species you choose for your new kitchen or bath cabinetry, please keep in mind that no two pieces of wood are exactly the same. Stains are likely to exaggerate the difference between open and closed grains and other markings in wood. Grain variation and color change should be expected. As hardwood ages, it will darken when exposed to different types of light. Color differences or changes in wood can also be caused by exposure to harsh chemicals, extreme heat or moisture. Additionally, wood species exhibit other defining characteristics, such as mineral deposits/streaks, knots, sap runs, pin holes and wormholes. These markings make the wood unique and contribute to its enduring beauty.



**Alder** has a straight fine textured grain similar to Cherry and Maple. Although classified as a hardwood, it is moderately light in weight and considerably softer than other species. Therefore, care must be taken as it will dent and mar easily. Alder may exhibit grain and color variations, sapwood can be distinguishable from the heartwood, tight pin knots are sometimes present.



**Cherry** is characterized by its red undertones, but may vary in color from white to a deep, rich brown. Cherry is a close-grained wood with fairly uniform texture, revealing pin knots and curly graining. All wood will age with time and the finish will darken. This is especially true for Cherry. This is a sought-after quality in Cherry cabinetry, and those who select it expect this evolution.



**Hickory** is a strong, heavy hardwood known for distinctive graining patterns. Contributing to its dramatic appearance is a wide variation in color and streaking, ranging from white to dark brown. This contrast in color can appear in a single door panel. Hickory also contains random knots and wormholes that further contribute to a varied appearance. These exaggerated characteristics are to be expected and are considered desirable in Hickory cabinetry.



**Maple** is a close-grained hardwood that is predominately white to creamy-white in color, with occasional reddish-brown tones. While Maple typically features uniform graining as compared to other wood species, characteristic markings may include fine brown lines, wavy or curly graining, bird pecks and mineral streaks. These traits are natural and serve to enhance Maple's natural beauty.



**Oak** is a strong, open-grained hardwood that ranges in color from white to pink and reddish tones. Streaks of green, yellow and even black may appear due to mineral deposits. Oak may also contain wormholes and wild, varying grain patterns. This distinct graining is considered a desirable quality.



## CHARACTERISTICS OF WOOD TYPES (cont'd)



**Rustic Alder** is characterized by its light brown and reddish undertones and may contain a variety of pin holes, open and closed knots of various sizes and colors, small cracks, bird pecks, mineral streaks, and grain variation. Some knots may have small holes through the panel. Larger holes will not be filled. In addition, the wood will contain color difference caused by variations in minerals found in the soil, creating visible mineral tracks.

**Sound Closed Knot** (not moveable) – Expected in Rustic Alder up to approximately 3" diameter.

**Sound Knot with Cracks** – Expect sound knots with open cracks up to approximately 1" in length.

**Open Knot** (through door) – Expected in Rustic Alder with open area up to approximately 3/4" diameter. Note: 3/4" diameter is about the size of a penny. Holes created by open knots pass completely through the door and are desirable for this rustic look.

**Unsound Knot** (moveable core) – Not to be expected.

**Knot Cluster** (cluster of tight sound knots) – To be expected in Rustic Alder.

**Worm Holes/Pin Holes** (can go through door) – Can be expected on Rustic Alder up to approximately 1/4" diameter.

**Worm Tracks** – Can be expected on Rustic Alder in sizes up to approximately 1/8" wide by 8" long.

## CHARACTERISTICS OF MDF

MDF (Medium Density Fiberboard) is an engineered wood product that is composed of wood fibers and resin that are then compressed to create a smooth uniform surface with a consistent core. Painted MDF eliminates the appearance of naturally occurring wood characteristics such as grain patterns, knots or mineral streaks, and is more resistant to warping, expanding and contracting due to environmental changes than solid hardwoods.

## CHARACTERISTICS OF GLAZING/PAINT

### Characteristics of Glazing

A professional layer of glaze can add another layer of beauty to your cabinets. First, our craftsmen apply a wood toner, which accentuates the grain's natural attributes. We then add the glaze, by hand, adding depth, dimension and an understated sheen that's guaranteed to endure.

### What to expect from glazed cabinetry...

- Glazing will range from a consistent, even appearance to varied coverage.
- You should expect the result to yield a subtle to dramatic look based on the complexity of a cabinet door's design, as glaze may collect in the corners and grooves.
- Printed materials and online, electronic presentations can only do so much. It's important to both see and touch actual finished samples to ensure your satisfaction.

### Characteristics of Paint Finish

Paint may develop hairline cracks in the finish, most notable around the joints. This is a result of natural expansion and contraction of the genuine hardwoods used in the manufacturing of this product. Hairline cracks are not considered a defect in the cabinetry or finish.

## CHARACTERISTICS OF SPECIALTY LAMINATES

**Specialty Laminates** feature design leading, high definition wood grain or high gloss laminates on doors, drawer fronts, overlay fillers, and Premium trim items. The surfaces are laminate based materials with an integrated top coat that provides superior beauty, durability, and performance while meeting or exceeding all of the KCMA performance standards. The core panel material is made of MDF to ensure a consistent and stable product. Additional coordinating trim items in the cabinet box color are also available.

Grain characteristics will vary across laminated parts to mimic natural wood grain patterns.

A heat shield is required to separate all laminate products from heat producing units to be in compliance with cabinet warranty.

## CHARACTERISTICS OF PURESTYLE™ & THERMOFOIL

**PureStyle™** is the process of wrapping durable laminate materials around door frames and select trim and premium mouldings resulting in products with crisp styling features and a surface that provides abrasion resistance and meets/exceeds all of the KCMA performance standards. PureStyle™ products are wrapped (versus form pressed onto a Medium Density Fiberboard (MDF) slab like thermofoil) and has a clear, integrated top coat for superior durability. The lineals and core panel material are made of MDF to ensure a consistent and stable product.

These doors offer the durability of a laminate and the beauty of paint and finished wood while bringing peace of mind to those who care about creating a better environment—both inside and outside of their homes.

Textured wood grain PureStyle™ doors feature design leading, high definition wood grain laminates on doors, drawer fronts, overlay fillers, and Premium trim items. The surfaces are laminate based materials with an integrated top coat that provides superior beauty, durability, and performance while meeting or exceeding all of the KCMA performance standards. The core panel material is made of MDF to ensure a consistent and stable product. Additional coordinating trim items in the cabinet box color are also available.

Grain characteristics will vary across laminated parts to mimic natural wood grain patterns.

**Thermofoil** doors and drawer fronts feature a shaped MDF core covered with a seamless vinyl material on the face and edges, and a melamine layer on the back. The vinyl material is applied to the MDF with an adhesive, and heat and pressure are used to create a product with excellent wear and heat resistance properties.

## DIAMOND CABINETRY'S 12-STEP FINISHING PROCESS

- 1. Wood Selection** – The selection of the finest woods including Alder, Cherry, Hickory, Maple, Oak, and Rustic Alder is the essential first step of Diamond's 12-step finishing process.
- 2. Sanded to Perfection** – Our sanding utilizes a fine grit paper, both with and against the wood grain. This process is completed on a vacuum table, allowing for a wood surface that is free of dust particles.
- 3. Achieving Natural Wood Tone** – Toner is applied to selected finishes, enhancing the naturalistic wood appearance.
- 4. Stain Application** – A hand-sprayed deep penetrating stain is evenly applied to all surfaces for even coverage on all profiles.
- 5. Removal of Excess Stain** – The wood is hand-wiped to remove excess stain, emphasizing the cabinet's natural wood grain.
- 6. Catalyzed Sealer** – A tough, clear, catalyzed sealer is hand-sprayed on to protect the grain from moisture.
- 7. Drying Process** – For added durability, the sealed wood is oven cured to lock in the beauty of wood.
- 8. Hand-Sanded** – To achieve an ultra-smooth finish, we hand-sand the material one last time.
- 9. Dust Removal** – The resulting loose dust particles are removed from the surface of the wood.
- 10. Catalyzed Top Coat** – A premium quality catalyzed clear top coat is applied to protect the wood from environmental elements.
- 11. Final Top Coat Cure** – The top coat is cured to guarantee the strongest, most beautiful finish.
- 12. Final Inspection** – This last inspection is very thorough, ensuring quality and beauty. Our gift to you is that every cabinet is crafted with care.



# HUMIDIFICATION

The natural response of wood to changes in humidity is much more dramatic than most people realize. Here is a table showing (a) how much a cabinet door panel is likely to shrink in a low humidity environment, (b) how much a cabinet door is likely to expand in excess humidity, and (c) the total potential range of dimension changes from a muggy summer to a cold dry winter.

## Total Potential Movement (inches) of solid-wood panels

Species	Panel Dimension (inches)	(a) Winter	(b) Summer	(c) Annual Range
Alder/Rustic Alder	19.75	-0.27	0.25	0.52
Cherry	19.75	-0.26	0.25	0.51
Hickory	19.75	-0.34	0.31	0.65
Maple	19.75	-0.49	0.10	0.59
Oak	19.75	-0.32	0.31	0.63

Notice the annual dimension change for a solid-wood panel can approach three-quarters of an inch! For this reason, cabinet doors are typically manufactured at a targeted range of 40% – 50% relative humidity. This usually works very well because even low humidity environments stay between 20% and 70% in normal years with typical cooking and washing activities.

In extremely cold, dry winters, some doors can be exposed to conditions that are below 20% relative humidity for weeks at a time. Exposure to sustained conditions such as these would cause panels to shrink and will not be considered defective. New construction intensifies this issue since the heat is on but no one is living in the home to raise the humidity levels. Conversely, where in-home humidity exceeds 70% relative humidity for extended periods of time, panels will swell and this will not be considered defective.

## Steps Consumers Can Take To Protect Real Wood Furnishings

- **Keep an eye on the humidity inside the home.** Reasonably accurate digital thermometers-hygrometer units are available to measure humidity.
- **Maintain the humidity at or above 20% when the temperature is below 20°F and over 35% when the temperature is above 20°F.** Some ways this may be accomplished are installing a whole-house humidifier on the furnace, running a portable humidifier in key rooms, or placing pans of water near the heat registers.
- **Don't over-do it.** Significant condensation on windows is a sign the humidity levels are too high for outside temperature conditions.
- **Recognize that finished wood responds to humidity over several days to several weeks.** It takes time before the wood returns to normal after any correction to the environment.

## WOOD DUST WARNING:

When cutting, sanding, sawing, or shaping cabinets or wood products, you are likely to generate wood dust. For your own safety, we recommend that you wear a protective mask to prevent breathing wood dust. We also recommend eye protection to avoid injury by flying wood chips or sawdust during cabinet installation.

## CARB COMPLIANCE:

Diamond is committed to offering solutions that meet or exceed air emissions rules and regulations. All composite wood products used in the construction of our cabinets for end panels, shelves, tops, bottoms, backs, toekicks, and corner blocks are compliant with the California Air Resources Board (CARB) regulations for formaldehyde emissions.

# Diamond®

## DISTINCTION™ SERIES

### Door Style Reference Chart

6

DOOR STYLES

	Alder	Cherry	Hickory	Maple	 MDF*	Oak	PureStyle™	Rustic Alder	Specialty Laminates	Thermofoil
Anden				✓						
Bailey		✓		✓						
Breman	✓	✓		✓	✓	✓		✓		
Caldera		✓		✓	✓					
Carson	✓							✓		
Catalina										✓
Crandall	✓	✓	✓	✓		✓		✓		
Cullen		✓		✓						
Davis		✓		✓						
Evans		✓	✓	✓		✓				
Graniti									✓	
Hanlon		✓		✓						
Julien		✓		✓						
LaGrange		✓		✓						
Laureldale		✓		✓						
Leeton		✓		✓						
Liberty		✓		✓						
Monterey		✓		✓		✓				
Montgomery	✓	✓	✓	✓	✓			✓		
Perkins		✓	✓	✓		✓				
Ridgefield		✓		✓		✓				
Rothshire		✓		✓						
Selena	✓	✓		✓						
Shiloh	✓	✓		✓				✓		
Sullivan		✓		✓						
Sumner	✓	✓		✓		✓		✓		
Tranter									✓	
Trystan		✓		✓	✓					
Wells		✓		✓						
Wixom									✓	
Worthen							✓			

\*Available soon.

# FULL OVERLAY DOOR STYLES

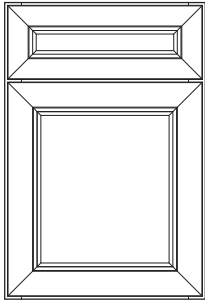

Anden Square  
(page 10)

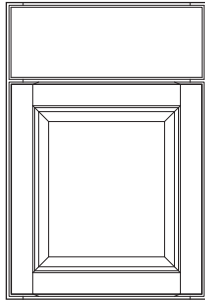

Bailey Square and Arch  
(page 10)

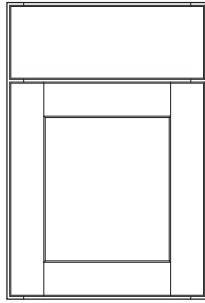

Breman Square  
(page 11)

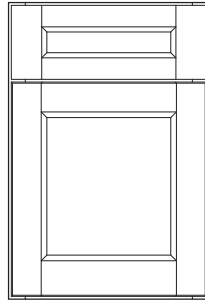

Caldera Square  
(page 11)

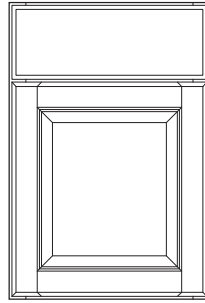

Carson Square  
(page 12)

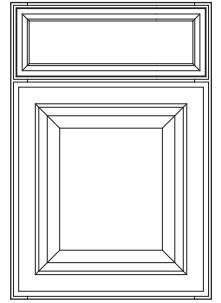

Catalina Square  
(page 12)

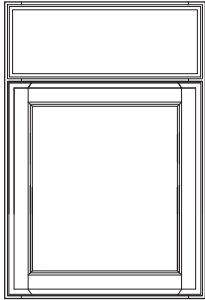

Cullen Square  
(page 13)

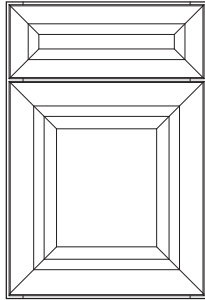

Davis Square  
(page 14)

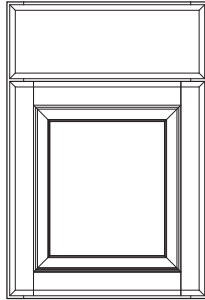

Evans Square  
(page 14)

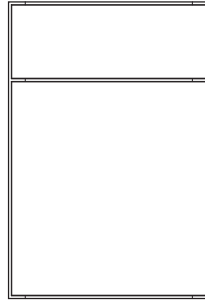

Graniti Slab  
(page 15)

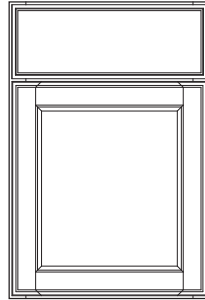

Hanlon Square  
(page 15)

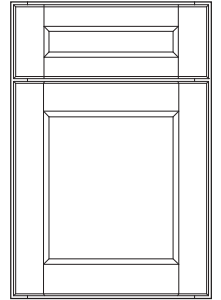

Julien Square  
(page 16)

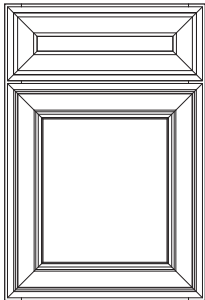

LaGrange Square  
(page 16)

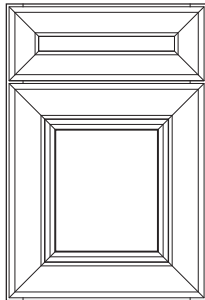

Laureldale Square  
(page 17)

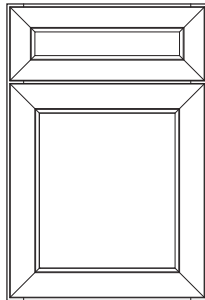

Leeton Square  
(page 17)

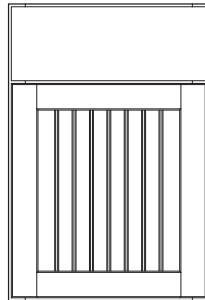

Liberty Square  
(page 18)

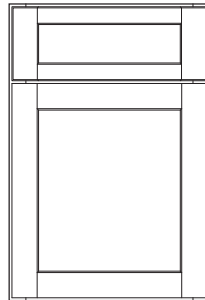

Montgomery Square  
(page 19)

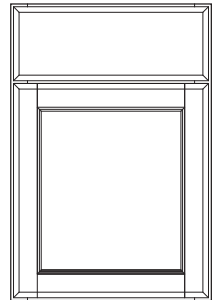

Perkins Square  
(page 19)

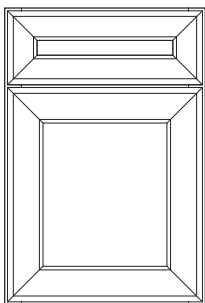

Rothshire Square  
(page 20)

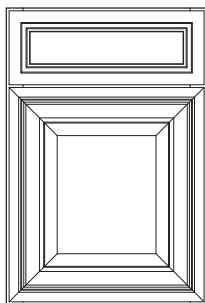

Selena Square  
(page 21)

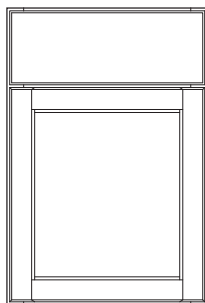

Shiloh Square  
(page 21)

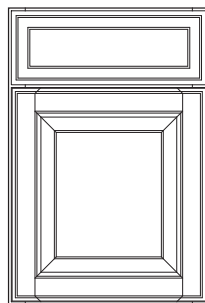

Sullivan Square and Arch  
(page 22)

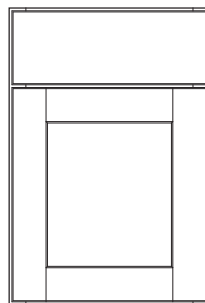

Sumner Square  
(page 22)

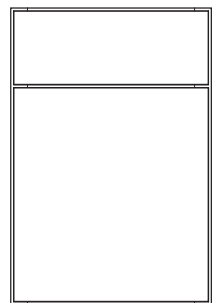

Tranter Slab  
(page 23)

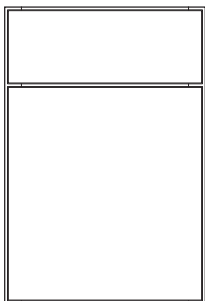

Trystan Slab  
(page 23)

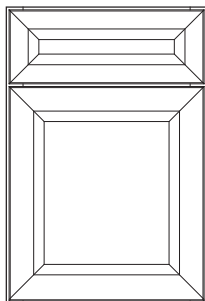

Wells Square  
(page 24)

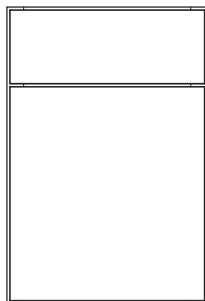

Wixom Slab  
(page 24)

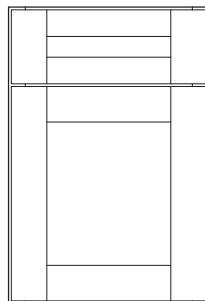

Worthen Square  
(page 25)

## PARTIAL OVERLAY DOOR STYLES

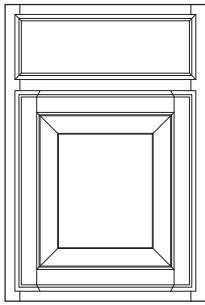

Crandall Square and Arch  
(page 13)

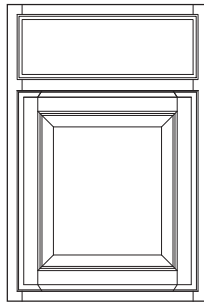

Monterey Square and Arch  
(page 18)

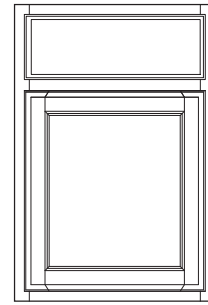

Ridgefield Square  
(page 20)

## FULL AND PARTIAL OVERLAY SPECIFICATIONS

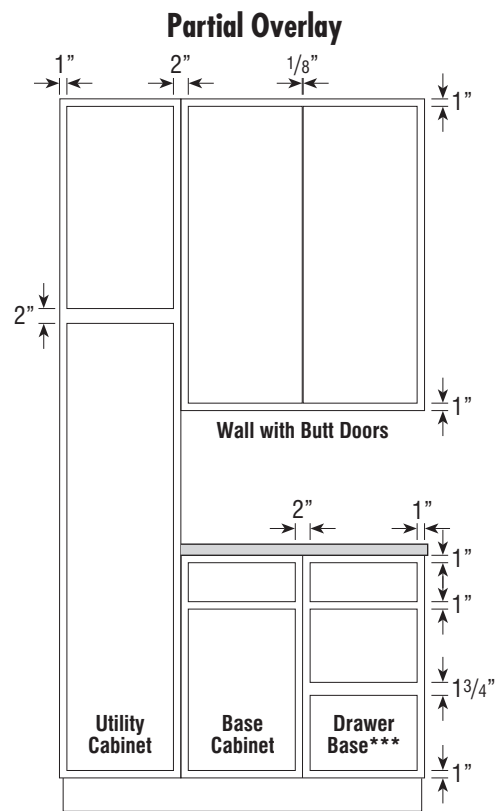
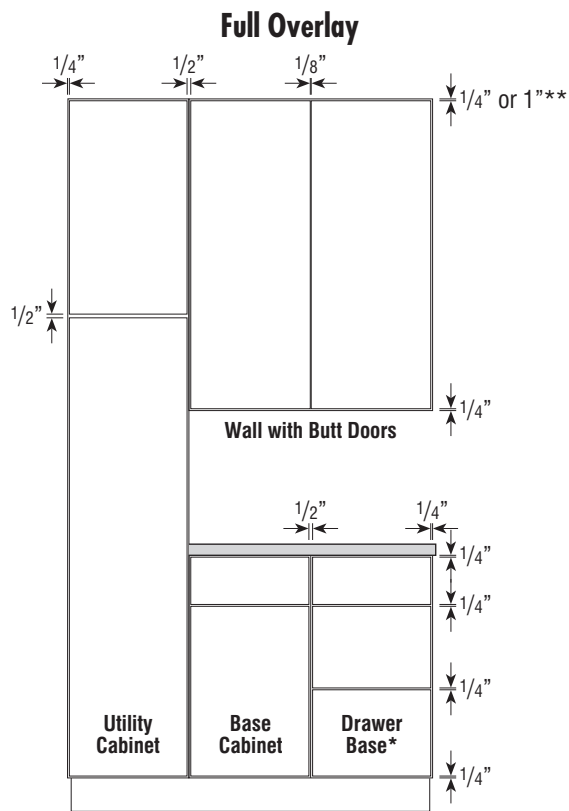

\*34 1/2" high application shown. On 32" high Full Overlay three drawer applications (drawer bases and sink bases with drawers), the reveal above the bottom drawer front is 1/2".

On 29" high Full Overlay DDR\_\_ (Desk Drawer Base), the reveal above bottom drawer is 3/4".

\*\*\*1" reveal when MFO is chosen

\*\*\*On Partial Overlay 2DB.. (Two Drawer Bases), reveal above the bottom drawer front is 2".

One double door center stile cabinet has the same reveal as two single door cabinets.



# DOOR STYLE SPECIFICATIONS

## Arch

- 9" wide wall cabinets will come in Arch if an Arch door style is selected.
- Base cabinets ordered in Arch will have Square doors.

## Cherry

- When Cherry door styles are ordered, it is recommended to apply a finished end option or a veneer end panel for exposed ends due to the natural aging of Cherry.

## Maple

- When a Paint or Paint with Glaze finish is specified, the door and/or drawer front center panel may be constructed of Medium Density Fiberboard (MDF), except when Liberty door style or when Distressing or Heirlooming are specified. MDF provides a smoother finish when painted, and is more resistant to warping, expansion, and contraction.

## MDF

- MDF door styles will use Maple for trim and panels, refer to Maple in the Species Availability charts.

## Rustic Alder

- See trim section for availability of Rustic characteristics on trim items.

## All Door Styles

- All doors and drawer fronts are 3/4" thick unless otherwise noted.

## Door and Drawer Front Side Profiles

- Veneer and MDF components are shown with gray shading on side profiles. Solid-wood components do not have shading.
- On MDF door styles, all door and drawer front components will be in MDF.

## Wood Grain

- Shaker door styles (Liberty and Montgomery) have a vertical grain direction on the drawer front center panel.
- Graniti drawer fronts have vertical grain.
- See reference images for wood grain direction on all other door styles.

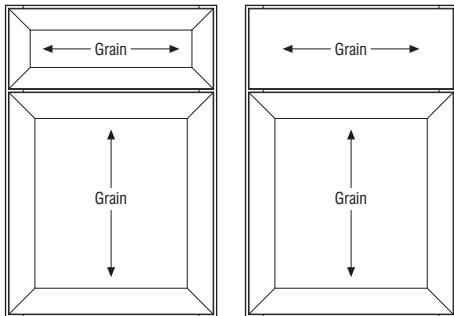

# DOOR STYLES

## Anden

	Alder	Cherry	Hickory	Maple*	MDF	Oak	PureStyle™	Rustic Alder	Specialty Laminates	Thermofoil
Availability	—	—	—	✓	—	—	—	—	—	—

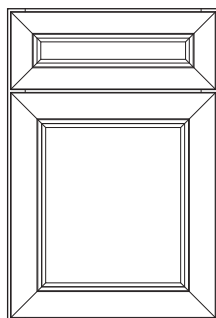

Square Base

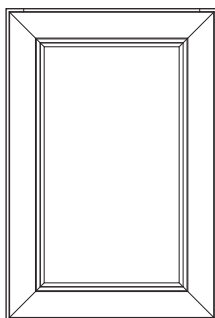

Square Wall



Optional Drawer Front:  
Slab (DFS LB)

### Door Options

ALF	CG	DPSRR	MD	SHMD	PRMD
•	•		•		

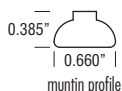

muntin profile

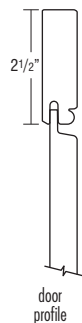

door profile

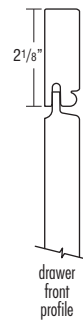

drawer front profile

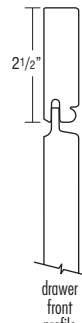

drawer front profile 10"+



optional drawer front profile

- Square Base and Square Wall Miter Doors
- Solid Raised Panel
- Full Overlay
- 5-Piece Drawer Front Mitered to Match Door
- Distressing Available

- See page 77 for 5-piece drawer front dimensions when specifying decorative hardware.

\*When a Paint or Paint with Glaze finish is specified, the door and/or drawer front center panel may be constructed of Medium Density Fiberboard (MDF), except when Distressing or Heirlooming are specified. MDF provides a smoother finish when painted, and is more resistant to warping, expansion, and contraction.

## Bailey

	Alder	Cherry	Hickory	Maple*	MDF	Oak	PureStyle™	Rustic Alder	Specialty Laminates	Thermofoil
Availability	—	✓	—	✓	—	—	—	—	—	—

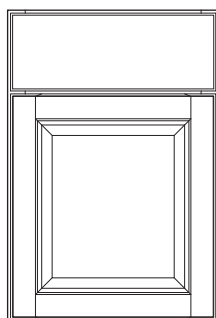

Square Base

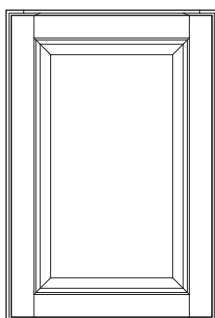

Square Wall

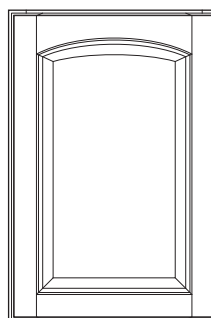

Arch Wall

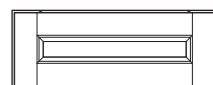

Optional Drawer Front:  
Flat 5-Piece (DFF5PC)

### Door Options

ALF	CG	DPSRR	MD	SHMD	PRMD
•	•		•		

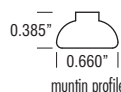

muntin profile

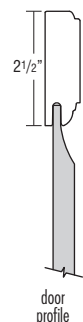

door profile

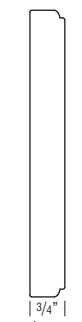

drawer front profile

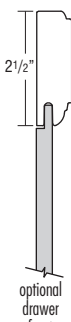

optional drawer front profile

- Square Base and Square or Arch Wall Doors
- Veneer Raised Panel
- Full Overlay
- Profiled Slab Drawer Front

- See page 77 for 5-piece drawer front dimensions when specifying decorative hardware.

\*When a Paint or Paint with Glaze finish is specified, the door and/or drawer front center panel may be constructed of Medium Density Fiberboard (MDF). MDF provides a smoother finish when painted, and is more resistant to warping, expansion, and contraction.

# DOOR STYLES

## Breman

	Alder	Cherry	Hickory	Maple*	<b>NEW</b> MDF**	Oak	PureStyle™	Rustic Alder	Specialty Laminates	Thermofoil
<b>Availability</b>	✓	✓	—	✓	✓	✓	—	✓	—	—

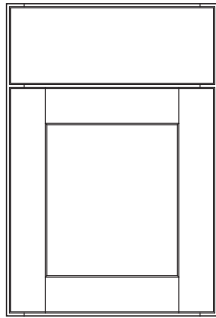

Square Base

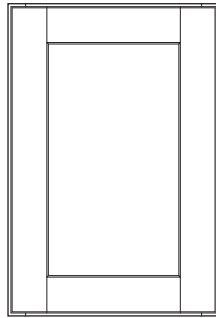

Square Wall

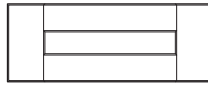

Optional Drawer Front:  
Flat 5-Piece (DFF5PC)

**Door Options**

ALF	CG	DPSRR	MD	SHMD	PRMD
•	•	•	•	•	•

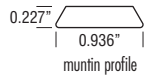

muntin profile

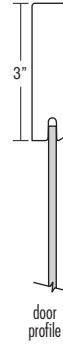

door profile



3/4" |  
drawer front profile

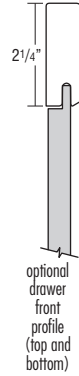

optional drawer front profile (top and bottom)

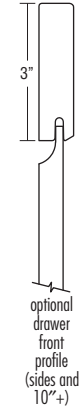

optional drawer front profile (sides and 10"+)

- Square Base and Square Wall Doors
- Veneer\*\*\* Flat Panel
- Full Overlay
- Slab Drawer Front
- See page 77 for 5-piece drawer front dimensions when specifying decorative hardware.

\*When a Paint or Paint with Glaze finish is specified, the door and/or drawer front center panel may be constructed of Medium Density Fiberboard (MDF), except when Heirlooming is specified. MDF provides a smoother finish when painted, and is more resistant to warping, expansion, and contraction.

\*\*Available soon.

\*\*\*When ordered in MDF, all door and drawer front components will be in MDF.

## Caldera

	Alder	Cherry	Hickory	Maple*	<b>NEW</b> MDF**	Oak	PureStyle™	Rustic Alder	Specialty Laminates	Thermofoil
<b>Availability</b>	—	✓	—	✓	✓	—	—	—	—	—

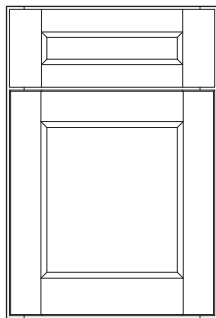

Square Base

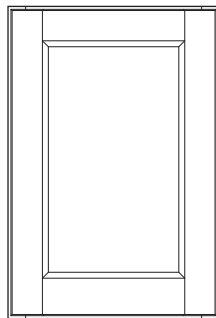

Square Wall

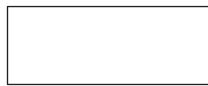

Optional Drawer Front:  
Slab (DFSLB)

**Door Options**

ALF	CG	DPSRR	MD	SHMD	PRMD
•	•	•	•	•	•

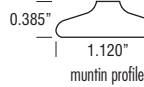

muntin profile

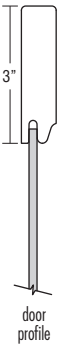

door profile

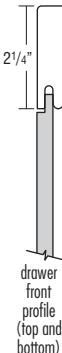

drawer front profile (top and bottom)

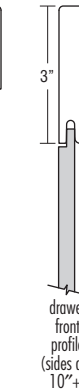

drawer front profile (sides and 10"+)



3/4" |  
optional drawer front profile

- Square Base and Square Wall Doors
- Veneer\*\*\* Flat Panel
- Full Overlay
- 5-Piece Drawer Front
- See page 77 for 5-piece drawer front dimensions when specifying decorative hardware.

\*When a Paint or Paint with Glaze finish is specified, the door and/or drawer front center panel may be constructed of Medium Density Fiberboard (MDF), except when Heirlooming is specified. MDF provides a smoother finish when painted, and is more resistant to warping, expansion, and contraction.

\*\*Available soon.

\*\*\*When ordered in MDF, all door and drawer front components will be in MDF.

# DOOR STYLES

12

DOOR STYLES

Carson	Alder	Cherry	Hickory	Maple	MDF	Oak	PureStyle™	Rustic Alder	Specialty Laminates	Thermofoil
	Availability	✓	—	—	—	—	—	—	✓	—

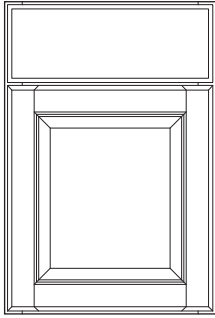

Square Base

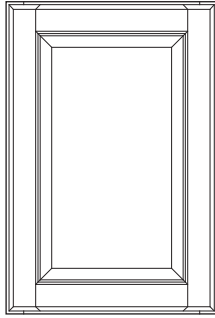

Square Wall

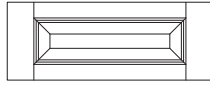

Optional Drawer Front:  
Raised 5-Piece (DFR5PC)

**Door Options**

ALF	CG	DPSRR	MD	SHMD	PRMD
•	•		•		



door profile



drawer front profile

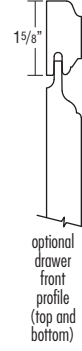

optional drawer front profile (top and bottom)

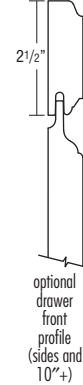

optional drawer front profile (sides and 10"+)

- Square Base and Square Wall Doors
- Solid Raised Panel
- Full Overlay

- Profiled Slab Drawer Front
- Distressing Available
- See page 77 for 5-piece drawer front dimensions when specifying decorative hardware.

Catalina	Alder	Cherry	Hickory	Maple	MDF	Oak	PureStyle™	Rustic Alder	Specialty Laminates	Thermofoil
	Availability	—	—	—	—	—	—	—	—	—

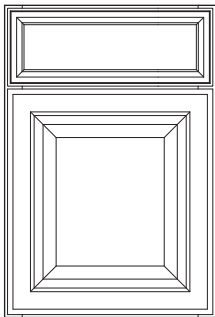

Square Base

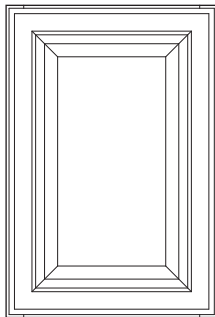

Square Wall

**Door Options**

ALF	CG	DPSRR	MD	SHMD	PRMD
•			•		

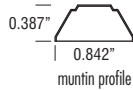

door profile



drawer front profile

- Square Base and Square Wall Doors
- Thermofoil MDF Raised Panel
- Full Overlay
- 1" MDF Raised Profile Drawer Front

- Thermofoil will not withstand sustained temperatures in excess of 170°F. A 3" filler or heat shield is required between any thermofoil surface and any heat source to be in compliance with cabinet warranty. Failure to use a 3" filler or heat shield will void the cabinet warranty.



# DOOR STYLES

## Crandall

	Alder	Cherry	Hickory	Maple*	MDF	Oak	PureStyle™	Rustic Alder	Specialty Laminates	Thermofoil
<b>Availability</b>	✓	✓	✓	✓	—	✓	—	✓	—	—

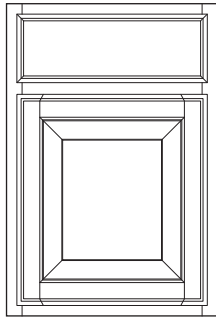

Square Base

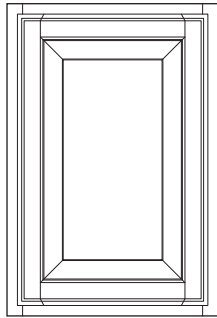

Square Wall

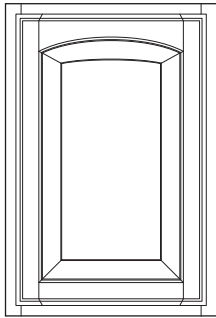

Arch Wall

**Door Options**

ALF	CG	DPSRR	MD	SHMD	PRMD
•	•		•		

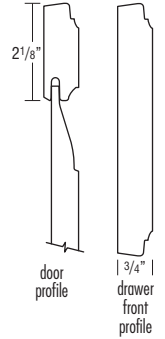
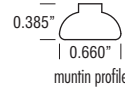

- Square Base and Square or Arch Wall Doors
- Solid Raised Panel
- Partial Overlay
- Profiled Slab Drawer Front
- Distressing Available

- Reverse Bevel Profile, Decorative Hardware Not Required

\*When a Paint or Paint with Glaze finish is specified, the door and/or drawer front center panel may be constructed of Medium Density Fiberboard (MDF), except when Distressing or Heirlooming are specified. MDF provides a smoother finish when painted, and is more resistant to warping, expansion, and contraction.

## Cullen

	Alder	Cherry	Hickory	Maple*	MDF	Oak	PureStyle™	Rustic Alder	Specialty Laminates	Thermofoil
<b>Availability</b>	—	✓	—	✓	—	—	—	—	—	—

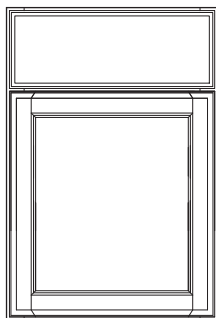

Square Base

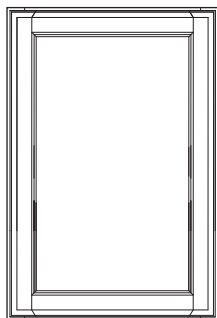

Square Wall

**Door Options**

ALF	CG	DPSRR	MD	SHMD	PRMD
•	•		•		

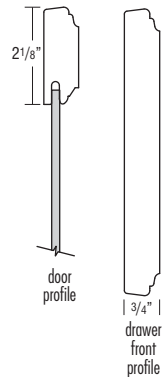
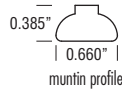

- Square Base and Square Wall Doors
- Veneer Flat Panel
- Full Overlay
- Profiled Slab Drawer Front

- Reverse Bevel Profile, Decorative Hardware Not Required

\*When a Paint or Paint with Glaze finish is specified, the door and/or drawer front center panel may be constructed of Medium Density Fiberboard (MDF), except when Heirlooming is specified. MDF provides a smoother finish when painted, and is more resistant to warping, expansion, and contraction.

# DOOR STYLES

## Davis

	Alder	Cherry	Hickory	Maple*	MDF	Oak	PureStyle™	Rustic Alder	Specialty Laminates	Thermofoil
Availability	—	✓	—	✓	—	—	—	—	—	—

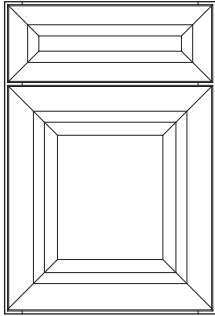

Square Base

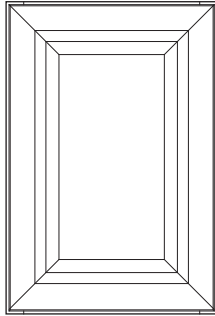

Square Wall



Optional Drawer Front:  
Slab (DFSLB)

### Door Options

ALF	CG	DPSRR	MD	SHMD	PRMD
•	•				

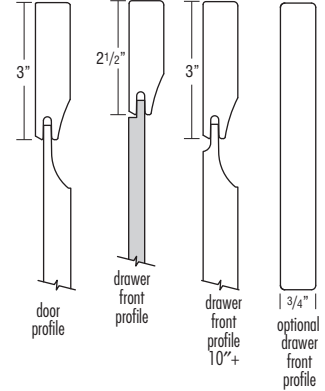

- Square Base and Square Wall Doors
- Solid Raised Panel Mitered Door
- Full Overlay
- 5-Piece Drawer Front Mitered to Match Door
- Distressing Available

- See page 77 for 5-piece drawer front dimensions when specifying decorative hardware.

\*When a Paint or Paint with Glaze finish is specified, the door and/or drawer front center panel may be constructed of Medium Density Fiberboard (MDF), except when Distressing or Heirlooming are specified. MDF provides a smoother finish when painted, and is more resistant to warping, expansion, and contraction.

## Evans

	Alder	Cherry	Hickory	Maple*	MDF	Oak	PureStyle™	Rustic Alder	Specialty Laminates	Thermofoil
Availability	—	✓	✓	✓	—	✓	—	—	—	—

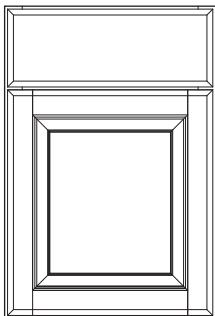

Square Base

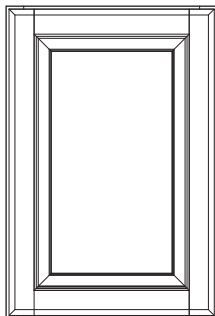

Square Wall

### Door Options

ALF	CG	DPSRR	MD	SHMD	PRMD
•	•		•		

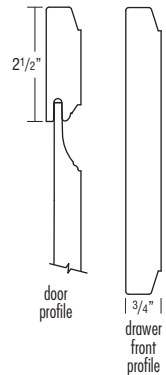
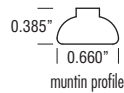

- Square Base and Square Wall Doors
- Solid Raised Panel
- Full Overlay
- Profiled Slab Drawer Front

- Distressing Available

\*When a Paint or Paint with Glaze finish is specified, the door may be constructed of Medium Density Fiberboard (MDF), except when Distressing or Heirlooming are specified. MDF provides a smoother finish when painted, and is more resistant to warping, expansion, and contraction.

# DOOR STYLES

## Graniti

	Alder	Cherry	Hickory	Maple	MDF	Oak	PureStyle™	Rustic Alder	Specialty Laminates	Thermofoil
Availability	—	—	—	—	—	—	—	—	✓	—

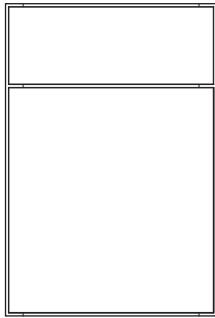

Slab Base

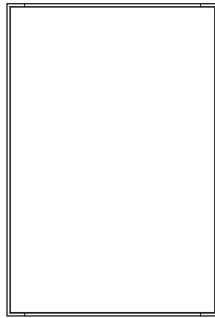

Slab Wall

**Door Options**

ALF	CG	DPSRR	MD	SHMD	PRMD
•					

**Finishes Cabinet Box Color Options**

Finishes	Cloud	Dover	Lambswool	Morel	Seal	Thatch	White
Antler	•	•	•	•			•
Elk					•	•	
Wharf		•	•				•

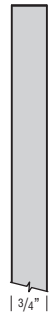

3/4" door profile



3/4" drawer front profile

- Slab Door and Drawer Front with Matching Edgebanding
- Elk and Wharf feature a textured surface, Antler is non-textured.
- Vertical Grain Pattern
- Full Overlay

- Doors, drawer fronts, overlay fillers, and selected premium trim items will be in the selected laminate. **All other cabinet components and trim items will be in the selected cabinet box color.**
- A heat shield is required to separate Graniti doors, drawer fronts, overlay fillers, and all laminate products from heat producing units to be in compliance with cabinet warranty.
- For complementing Contemporary Embellishments, see page 413.
- Wood Tone Stain box colors will have visible vertical grain matching end panels.

## Hanlon

	Alder	Cherry	Hickory	Maple*	MDF	Oak	PureStyle™	Rustic Alder	Specialty Laminates	Thermofoil
Availability	—	✓	—	✓	—	—	—	—	—	—

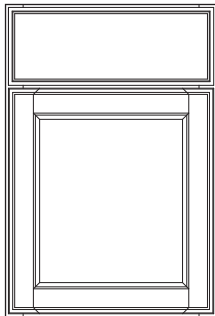

Square Base

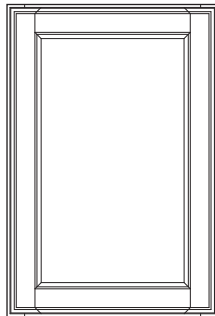

Square Wall

**Door Options**

ALF	CG	DPSRR	MD	SHMD	PRMD
•	•		•		

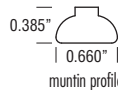

0.385" muntin profile

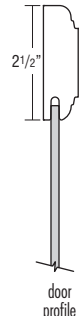

2 1/2" door profile



3/4" drawer front profile

- Square Base and Square Wall Doors
- Veneer Flat Panel
- Full Overlay
- Profiled Slab Drawer Front

\*When a Paint or Paint with Glaze finish is specified, the door and/or drawer front center panel may be constructed of Medium Density Fiberboard (MDF), except when Heirlooming is specified. MDF provides a smoother finish when painted, and is more resistant to warping, expansion, and contraction.

# DOOR STYLES

## Julien

	Alder	Cherry	Hickory	Maple*	MDF	Oak	PureStyle™	Rustic Alder	Specialty Laminates	Thermofoil
Availability	—	✓	—	✓	—	—	—	—	—	—

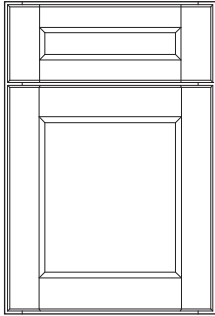

Square Base

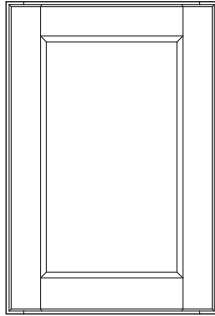

Square Wall



Optional Drawer Front:  
Slab (DFSLB)

### Door Options

ALF	CG	DPSRR	MD	SHMD	PRMD
•	•		•		

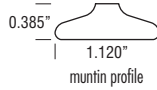

muntin profile

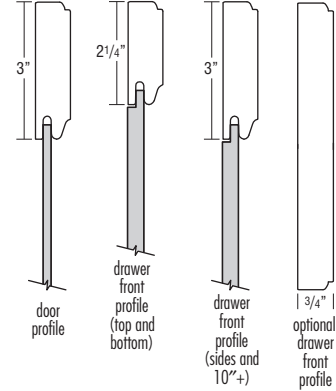

- Square Base and Square Wall Doors
- Veneer Flat Panel
- Full Overlay
- 5-Piece Drawer Front

- See page 77 for 5-piece drawer front dimensions when specifying decorative hardware.

\*When a Paint or Paint with Glaze finish is specified, the door and/or drawer front center panel may be constructed of Medium Density Fiberboard (MDF), except when Heirlooming is specified. MDF provides a smoother finish when painted, and is more resistant to warping, expansion, and contraction.

## LaGrange

	Alder	Cherry	Hickory	Maple*	MDF	Oak	PureStyle™	Rustic Alder	Specialty Laminates	Thermofoil
Availability	—	✓	—	✓	—	—	—	—	—	—

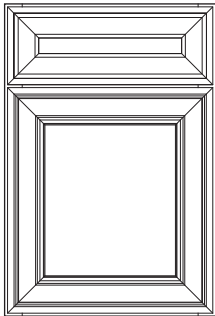

Square Base

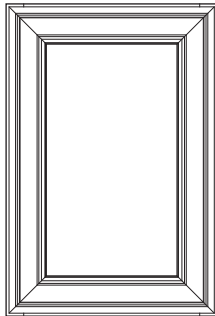

Square Wall

### Door Options

ALF	CG	DPSRR	MD	SHMD	PRMD
•	•		•		

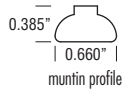

muntin profile

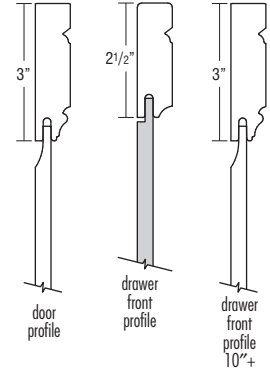

- Square Base and Square Wall Miter Doors
- Solid Reverse Raised Panel Door
- Full Overlay
- 5-Piece Drawer Front Mitered to Match Door
- Faux Inset Design. Recommended for use with Faux Hinges (see page 416).

- 1/4" space filler or extended stile modification is necessary when applying faux hinge (strap or barrel) on varying depth cabinet or next to an appliance to allow for full door swing clearance.

- See page 77 for 5-piece drawer front dimensions when specifying decorative hardware.

\*When a Paint or Paint with Glaze finish is specified, the door and/or drawer front center panel may be constructed of Medium Density Fiberboard (MDF), except when Heirlooming is specified. MDF provides a smoother finish when painted, and is more resistant to warping, expansion, and contraction.



# DOOR STYLES

## Laureldale

	Alder	Cherry	Hickory	Maple*	MDF	Oak	PureStyle™	Rustic Alder	Specialty Laminates	Thermofoil
Availability	—	✓	—	✓	—	—	—	—	—	—

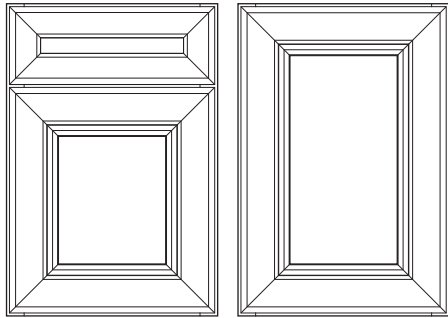

Square Base

Square Wall

### Door Options

ALF	CG	DPSRR	MD	SHMD	PRMD
•	•		•		

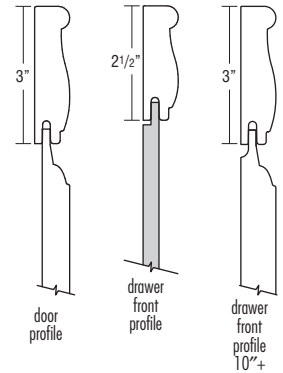
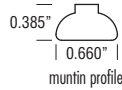

- Square Base and Square Wall Miter Doors
- Solid Raised Panel on Door and Large Drawer Fronts
- Full Overlay
- 5-Piece Drawer Front Mitered to Match Door
- Distressing Available

- See page 77 for 5-piece drawer front dimensions when specifying decorative hardware.
- \*When a Paint or Paint with Glaze finish is specified, the door and/or drawer front center panel may be constructed of Medium Density Fiberboard (MDF), except when Distressing or Heirlooming are specified. MDF provides a smoother finish when painted, and is more resistant to warping, expansion, and contraction.

## Leeton

	Alder	Cherry	Hickory	Maple*	MDF	Oak	PureStyle™	Rustic Alder	Specialty Laminates	Thermofoil
Availability	—	✓	—	✓	—	—	—	—	—	—

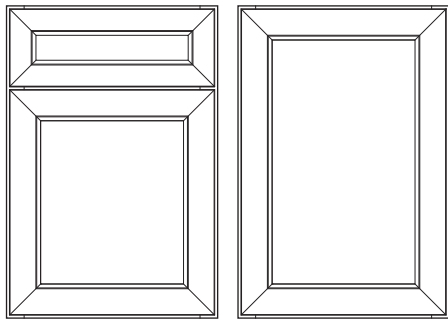

Square Base

Square Wall

Optional Drawer Front:  
Slab (DFSLB)

### Door Options

ALF	CG	DPSRR	MD	SHMD	PRMD
•	•		•		

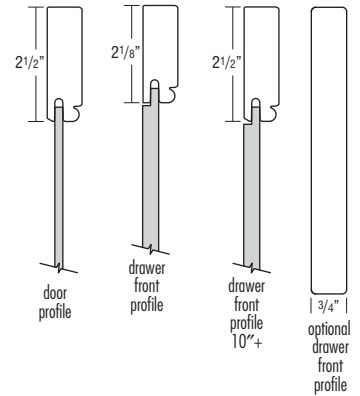
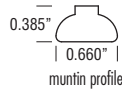

- Square Base and Square Wall Miter Doors
- Veneer Flat Panel
- Full Overlay
- 5-Piece Drawer Front Mitered to Match Door

- See page 77 for 5-piece drawer front dimensions when specifying decorative hardware.
- \*When a Paint or Paint with Glaze finish is specified, the door and/or drawer front center panel may be constructed of Medium Density Fiberboard (MDF), except when Heirlooming is specified. MDF provides a smoother finish when painted, and is more resistant to warping, expansion, and contraction.

# DOOR STYLES

Liberty	Alder	Cherry	Hickory	Maple	MDF	Oak	PureStyle™	Rustic Alder	Specialty Laminates	Thermofoil
<b>Availability</b>	—	✓	—	✓	—	—	—	—	—	—

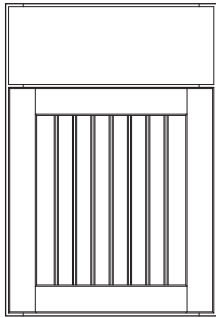

Square Base

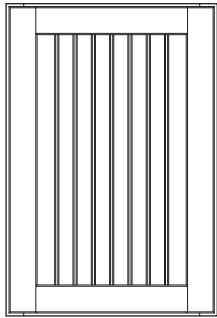

Square Wall

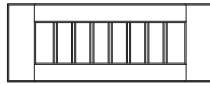

Optional Drawer Front:  
Flat 5-Piece (DFF5PC)

**Door Options**

ALF	CG	DPSRR	MD	SHMD	PRMD
•	•		•	•	•

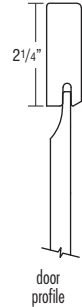
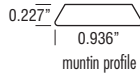

door profile

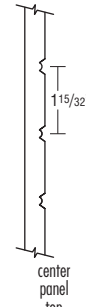

center panel top view



3/4\"/>



optional drawer front profile

- Square Base and Square Wall Shaker Style Doors
- Solid Reverse Raised Beaded Panel
- Full Overlay
- Slab Drawer Front
- When DFF5PC is selected on a 2DB48, drawer front will have a vertical cross rail with two center panels.

- Will not use MDF center panel on Paint or Paint with Glaze finishes. See page 9 for more details.
- Beaded center panel on 5-piece drawer fronts will not align with doors when used on cabinets with double doors and a full width drawer.
- See page 77 for 5-piece drawer front dimensions when specifying decorative hardware.

Monterey	Alder	Cherry	Hickory	Maple*	MDF	Oak	PureStyle™	Rustic Alder	Specialty Laminates	Thermofoil
<b>Availability</b>	—	✓	—	✓	—	✓	—	—	—	—

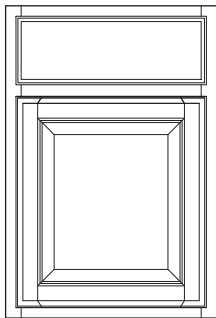

Square Base

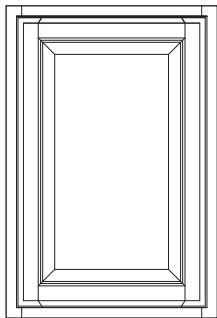

Square Wall

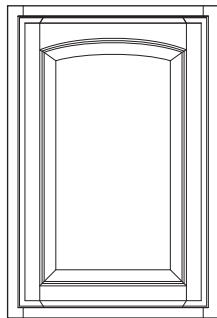

Arch Wall

**Door Options**

ALF	CG	DPSRR	MD	SHMD	PRMD
•	•		•		

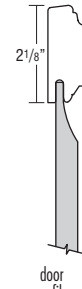
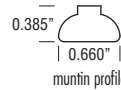

door profile



drawer front profile

- Square Base and Square or Arch Wall Doors
- Veneer Raised Panel
- Partial Overlay
- Profiled Slab Drawer Front

- Reverse Bevel Profile, Decorative Hardware Not Required
- \*When a Paint or Paint with Glaze finish is specified, the door and/or drawer front center panel may be constructed of Medium Density Fiberboard (MDF). MDF provides a smoother finish when painted, and is more resistant to warping, expansion, and contraction.

# DOOR STYLES

## Montgomery

	Alder	Cherry	Hickory	Maple*	MDF**	Oak	PureStyle™	Rustic Alder	Specialty Laminates	Thermofoil
Availability	✓	✓	✓	✓	✓	—	—	✓	—	—

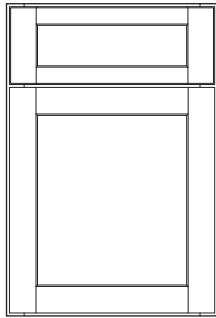

Square Base

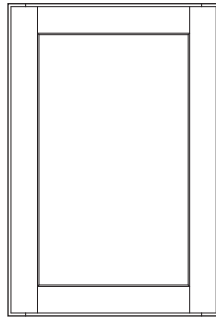

Square Wall



Optional Drawer Front:  
Slab (DFSLB)

**Door Options**

ALF	CG	DPSRR	MD	SHMD	PRMD
•	•	•	•	•	•

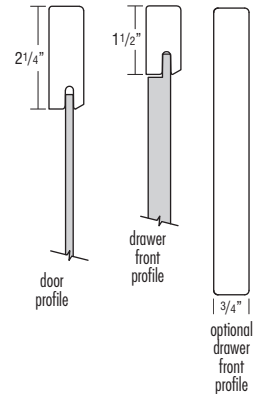
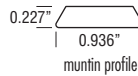

- Square Base and Square Wall Shaker Style Doors
- Veneer\*\*\* Flat Panel (Solid reverse raised door center panel is available as a modification, see DPSRR on page 40.)
- Full Overlay
- 5-Piece Drawer Front

- See page 77 for 5-piece drawer front dimensions when specifying decorative hardware.

\*When a Paint or Paint with Glaze finish is specified, the door and/or drawer front center panel may be constructed of Medium Density Fiberboard (MDF), except when Heirlooming is specified. MDF provides a smoother finish when painted, and is more resistant to warping, expansion, and contraction.

\*\*Available soon.

\*\*\*When ordered in MDF, all door and drawer front components will be in MDF.

## Perkins

	Alder	Cherry	Hickory	Maple*	MDF	Oak	PureStyle™	Rustic Alder	Specialty Laminates	Thermofoil
Availability	—	✓	✓	✓	—	✓	—	—	—	—

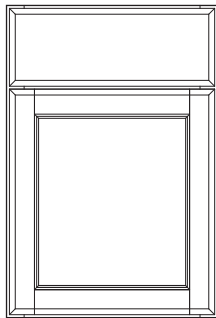

Square Base

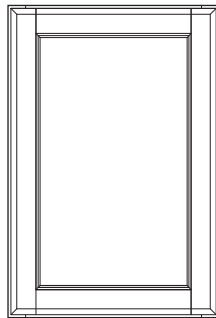

Square Wall

**Door Options**

ALF	CG	DPSRR	MD	SHMD	PRMD
•	•		•		

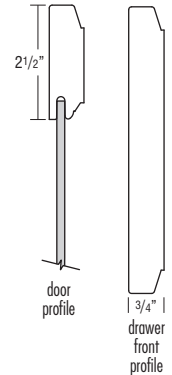
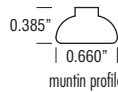

- Square Base and Square Wall Doors
- Veneer Flat Panel
- Full Overlay
- Profiled Slab Drawer Front

\*When a Paint or Paint with Glaze finish is specified, the door and/or drawer front center panel may be constructed of Medium Density Fiberboard (MDF), except when Heirlooming is specified. MDF provides a smoother finish when painted, and is more resistant to warping, expansion, and contraction.

# DOOR STYLES

## Ridgefield

	Alder	Cherry	Hickory	Maple*	MDF	Oak	PureStyle™	Rustic Alder	Specialty Laminates	Thermofoil
Availability	—	✓	—	✓	—	✓	—	—	—	—

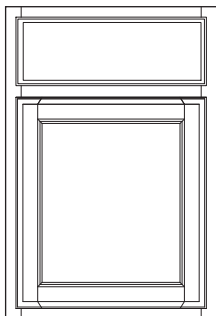

Square Base

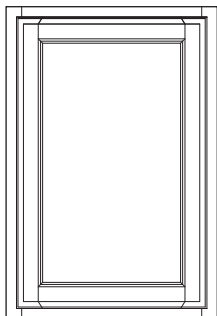

Square Wall

**Door Options**

ALF	CG	DPSRR	MD	SHMD	PRMD
•	•		•		

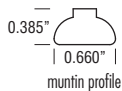

muntin profile

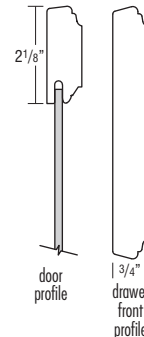

2 1/8"

door profile

3/4" | drawer front profile

- Square Base and Square Wall Doors
- Veneer Flat Panel
- Partial Overlay
- Profiled Slab Drawer Front

- Reverse Bevel Profile

\*When a Paint or Paint with Glaze finish is specified, the door and/or drawer front center panel may be constructed of Medium Density Fiberboard (MDF), except when Heirlooming is specified. MDF provides a smoother finish when painted, and is more resistant to warping, expansion, and contraction.

## Rothshire

	Alder	Cherry	Hickory	Maple*	MDF	Oak	PureStyle™	Rustic Alder	Specialty Laminates	Thermofoil
Availability	—	✓	—	✓	—	—	—	—	—	—

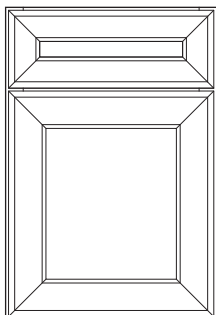

Square Base

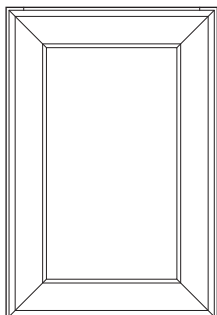

Square Wall

**Door Options**

ALF	CG	DPSRR	MD	SHMD	PRMD
•	•		•		



muntin profile

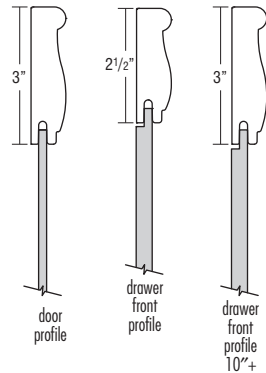

3"

door profile

2 1/2"

drawer front profile

3"

drawer front profile 10"+

- Square Base and Square Wall Miter Doors
- Veneer Flat Panel
- Full Overlay
- 5-Piece Drawer Front Mitered to Match Door

- See page 77 for 5-piece drawer front dimensions when specifying decorative hardware.

\*When a Paint or Paint with Glaze finish is specified, the door and/or drawer front center panel may be constructed of Medium Density Fiberboard (MDF), except when Heirlooming is specified. MDF provides a smoother finish when painted, and is more resistant to warping, expansion, and contraction.



# DOOR STYLES

## Selena

	Alder	Cherry	Hickory	Maple*	MDF	Oak	PureStyle™	Rustic Alder	Specialty Laminates	Thermofoil
Availability	✓	✓	—	✓	—	—	—	—	—	—

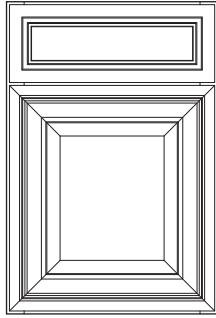

Square Base

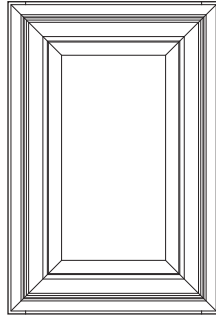

Square Wall

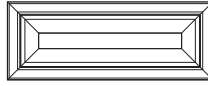

Optional Drawer Front:  
Flat 5-Piece (DFF5PC)

**Door Options**

ALF	CG	DPSRR	MD	SHMD	PRMD
•	•		•		



door profile

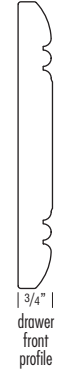

drawer front profile



optional drawer front profile

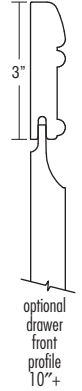

optional drawer front profile 10\"/>

- Square Base and Square Wall Miter Doors
- Solid Raised Panel on Door and Large 5-Piece Drawer Fronts
- Full Overlay
- Solid Routed Drawer Front
- 5-piece 6 1/4" and 6 3/4" high drawer fronts have a flat center panel, 10" and taller drawer fronts have a raised center panel.

- Distressing Available
- See page 77 for 5-piece drawer front dimensions when specifying decorative hardware.

\*When a Paint or Paint with Glaze finish is specified, the door and/or drawer front center panel may be constructed of Medium Density Fiberboard (MDF), except when Distressing or Heirlooming are specified. MDF provides a smoother finish when painted, and is more resistant to warping, expansion, and contraction.

## Shiloh

	Alder	Cherry	Hickory	Maple*	MDF	Oak	PureStyle™	Rustic Alder	Specialty Laminates	Thermofoil
Availability	✓	✓	—	✓	—	—	—	✓	—	—

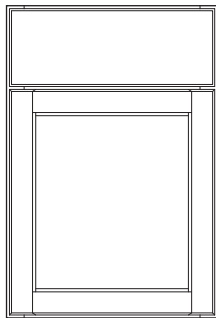

Square Base

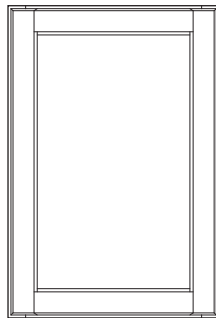

Square Wall

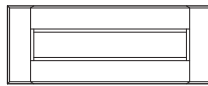

Optional Drawer Front:  
Flat 5-Piece (DFF5PC)

**Door Options**

ALF	CG	DPSRR	MD	SHMD	PRMD
•	•		•		

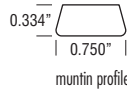

door profile



drawer front profile

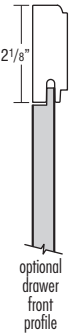

optional drawer front profile

- Square Base and Square Wall Doors
- Veneer Flat Panel
- Full Overlay
- Profiled Slab Drawer Front

- See page 77 for 5-piece drawer front dimensions when specifying decorative hardware.

\*When a Paint or Paint with Glaze finish is specified, the door and/or drawer front center panel may be constructed of Medium Density Fiberboard (MDF), except when Heirlooming is specified. MDF provides a smoother finish when painted, and is more resistant to warping, expansion, and contraction.

# DOOR STYLES

Sullivan	Alder	Cherry	Hickory	Maple*	MDF	Oak	PureStyle™	Rustic Alder	Specialty Laminates	Thermofoil
	Availability	—	✓	—	✓	—	—	—	—	—

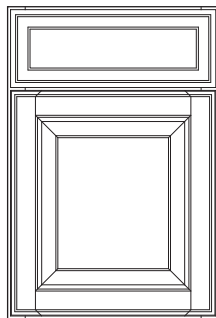

Square Base

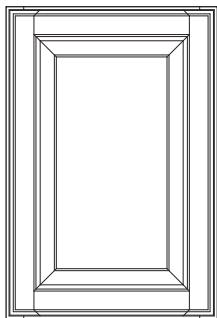

Square Wall

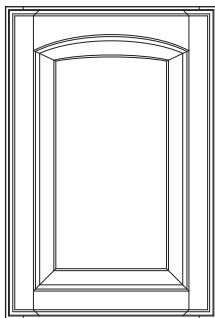

Arch Wall



Optional Drawer Front:  
Slab (DFSLSB)



Optional Drawer Front:  
Raised 5-Piece (DFR5PC)

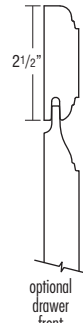
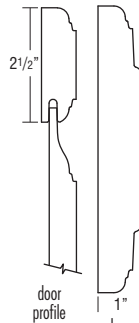

**Door Options**

ALF	CG	DPSRR	MD	SHMD	PRMD
•	•		•		



- Square Base and Square or Arch Wall Doors
- Solid Raised Panel
- Full Overlay
- 1" Raised Profile Drawer Front
- Distressing Available

- See page 77 for 5-piece drawer front dimensions when specifying decorative hardware.
- \*When a Paint or Paint with Glaze finish is specified, the door and/or drawer front center panel may be constructed of Medium Density Fiberboard (MDF), except when Distressing or Heirlooming are specified. MDF provides a smoother finish when painted, and is more resistant to warping, expansion, and contraction.

Sumner	Alder	Cherry	Hickory	Maple*	MDF	Oak	PureStyle™	Rustic Alder	Specialty Laminates	Thermofoil
	Availability	✓	✓	—	✓	—	—	✓	—	—

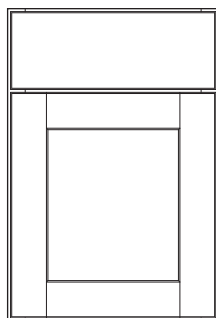

Square Base

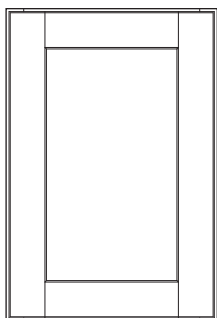

Square Wall

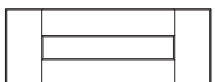

Optional Drawer Front:  
Flat 5-Piece (DFF5PC)

**Door Options**

ALF	CG	DPSRR	MD	SHMD	PRMD
•	•		•	•	•

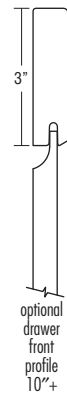
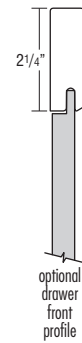
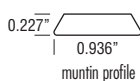

- Square Base and Square Wall Doors
- Solid Reverse Raised Panel Door
- Full Overlay
- Slab Drawer Front

- See page 77 for 5-piece drawer front dimensions when specifying decorative hardware.
- \*When a Paint or Paint with Glaze finish is specified, the door and/or drawer front center panel may be constructed of Medium Density Fiberboard (MDF), except when Heirlooming is specified. MDF provides a smoother finish when painted, and is more resistant to warping, expansion, and contraction.

# DOOR STYLES

## Tranter

	Alder	Cherry	Hickory	Maple	MDF	Oak	PureStyle™	Rustic Alder	Specialty Laminates	Thermofoil
Availability	—	—	—	—	—	—	—	—	✓	—

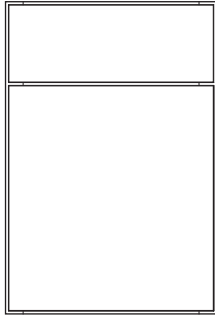

Slab Base

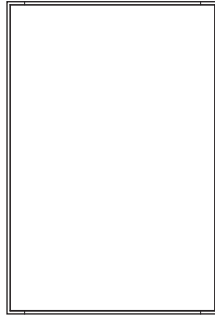

Slab Wall

**Door Options**

ALF	CG	DPSRR	MD	SHMD	PRMD
•					

**Specialty Laminate Finishes**

	Black†	Cloud	Dover	Icy Avalanche	Storm	White
Arctic		•	•	•		•
Obsidian	•				•	



3/4" door profile



3/4" drawer front profile

- Laminate Slab Door and Drawer Front with Matching Edgebanding
- Arctic and Obsidian feature a textured surface.
- Horizontal Grain Pattern for Contemporary Styling
- Full Overlay
- Doors, drawer fronts, overlay fillers, and selected premium trim items will be in the selected laminate. **All other cabinet components and trim items will be in the selected cabinet box color.**

- Doors and overlay fillers greater than 48" high will be two pieces. Doors will be doweled together with zinc connector pins and black plastic spacers. Replacement doors will be drilled and doweled but require field assembly.
  - A heat shield is required to separate Tranter doors, drawer fronts, overlay fillers, and all textured laminate products from heat producing units to be in compliance with cabinet warranty.
  - For complementing Contemporary Embellishments, see page 413.
  - Storm box color will have visible vertical grain matching end panels.
- †Distinction construction features non-matching laminate ends. Requires a veneer end upgrade (PE or APC) with FB, FPEB, Authentic End upgrade, or a field applied skin or door kit to achieve a matching cabinet end panel.

## Trystan

	Alder	Cherry	Hickory	Maple	<b>NEW</b> MDF*	Oak	PureStyle™	Rustic Alder	Specialty Laminates	Thermofoil
Availability	—	✓	—	✓	✓	—	—	—	—	—

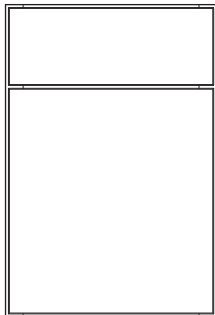

Slab Base

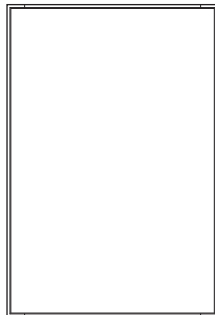

Slab Wall

**Door Options**

ALF	CG	DPSRR	MD	SHMD	PRMD
•					

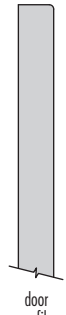

door profile



3/4" drawer front profile

- Slab Doors and Drawer Fronts
- Veneer Face and Back
- Wood Edging on All Edges
- Furniture Board Core

- Full Overlay
  - Grain direction is vertical on doors and horizontal on drawer fronts.
- \*Available soon. When ordered in MDF, all door and drawer front components will be in MDF.

# DOOR STYLES

Wells	Availability	Alder	Cherry	Hickory	Maple*	MDF	Oak	PureStyle™	Rustic Alder	Specialty Laminates	Thermofoil
	—	—	✓	—	✓	—	—	—	—	—	—

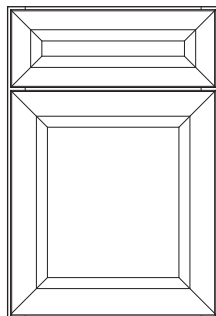

Square Base

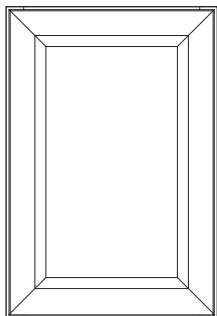

Square Wall



Optional Drawer Front:  
Slab (DFSFLB)

**Door Options**

ALF	CG	DPSRR	MD	SHMD	PRMD
•	•				

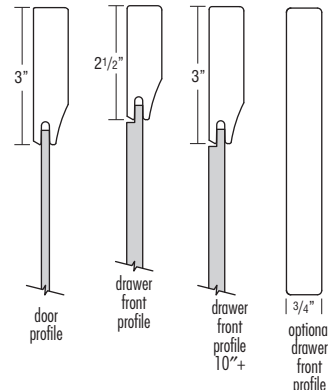

- Square Base and Square Wall Doors
- Veneer Flat Panel Mitered Door
- Full Overlay
- 5-Piece Drawer Front Mitered to Match Door

• See page 77 for 5-piece drawer front dimensions when specifying decorative hardware.

\*When a Paint or Paint with Glaze finish is specified, the door and/or drawer front center panel may be constructed of Medium Density Fiberboard (MDF), except when Heirlooming is specified. MDF provides a smoother finish when painted, and is more resistant to warping, expansion, and contraction.

Wixom	Availability	Alder	Cherry	Hickory	Maple	MDF	Oak	PureStyle™	Rustic Alder	Specialty Laminates	Thermofoil
	—	—	—	—	—	—	—	—	—	✓	—

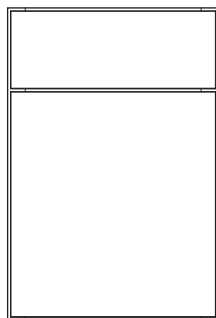

Slab Base

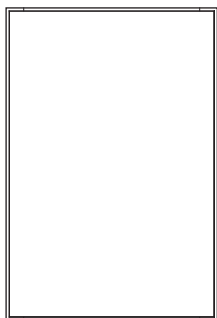

Slab Wall

**Door Options**

ALF	CG	DPSRR	MD	SHMD	PRMD
•					

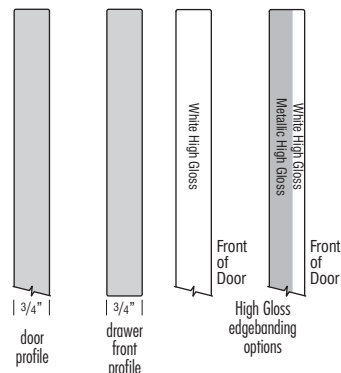

- Slab Doors and Drawer Fronts
- Full Overlay
- Two Edgbanding Options

- Doors, drawer fronts, overlay fillers, and selected premium trim items will be in White High Gloss (see Trim section for availability of premium trim items). Backs of doors, drawer fronts, and Premium panels will be white melamine. **All other cabinet components and embellishments will be Painted White.**
- A heat shield is required to separate Wixom doors, drawer fronts, overlay fillers, and all laminate products from heat producing units to be in compliance with cabinet warranty.
- For complementing Contemporary Embellishments, see page 413.

# DOOR STYLES

## Worthen

	Alder	Cherry	Hickory	Maple	MDF	Oak	PureStyle™	Rustic Alder	Specialty Laminates	Thermofoil
Availability	—	—	—	—	—	—	✓	—	—	—

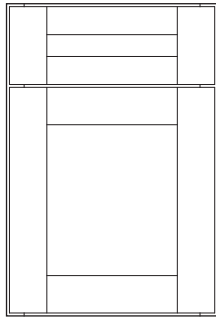

Square Base

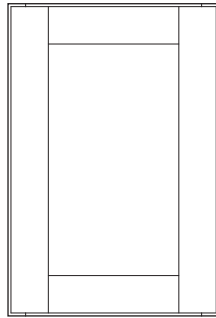

Square Wall

### Door Options

ALF	CG	DPSRR	MD	SHMD	PRMD
•					

### Cabinet Box Color Options

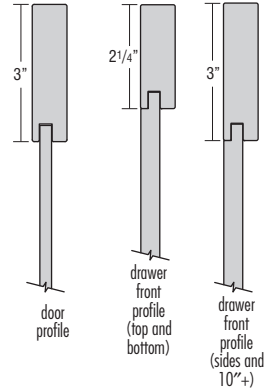

Seal	Thatch
•	•



- Square Base and Square Wall Doors
- Textured Wood Grain Laminate Wrapped MDF Door and Drawer Rails
- Full Overlay
- 5-Piece Drawer Front

- Doors, drawer fronts, overlay fillers, and selected premium trim items will be Elk. All other cabinet components and embellishments will be in selected cabinet box color and species.
- A heat shield is required to separate Worthen doors, drawer fronts, overlay fillers, and all laminate products from heat producing units to be in compliance with cabinet warranty.
- See page 77 for 5-piece drawer front dimensions when specifying decorative hardware.
- Wood Tone Stain box colors will have visible vertical grain matching end panels.



PREMIUM COLOR PALETTE						
	OPTION NAME	DESCRIPTION/ LIMITATIONS	MATCHING LAMINATE ENDS <sup>^</sup>	DISTRESSING AVAILABILITY	HEIRLOOMING AVAILABILITY	MATTE SHEEN AVAILABILITY
Stains	<b>Grizzly</b>	A deep brown finish with gray undertones and beautiful depth.	✓	✓	N/A	✓
	<b>Kodiak</b>	A dark brown finish with gray and yellow undertones and a deep, rich hue.	✓	✓	N/A	✓
	<b>Storm</b>	A semi translucent stone gray finish that allows the natural tones and characteristics of the wood to show through.	Maple ✓ Cherry N/A	✓	✓	✓
Stains with Glazes	<b>Black Forest</b>	A two tone finish. A medium toned finish that is highlighted with a dark glaze.	✓	✓	N/A	✓
	<b>Coffee</b>	A two tone finish. Dark glaze over a warmer toner that emulates a soft, Old World look and enhances the door profiles.	✓	✓	N/A	✓
	<b>Palomino</b>	A two tone finish. A light toned finish that is highlighted with a dark espresso glaze. The glaze is meant to be seen primarily in the profiled areas and has minimal affect to the overall color.	✓	✓	N/A	✓
	<b>Whiskey Black</b>	A warm finish with a rich dark patina to create a true reproduction of a period style antique.	✓	✓	N/A	✓
Paints*	<b>Black</b>	True black	N/A	✓	✓	N/A
	<b>Cloud</b>	Medium gray	✓	✓	N/A	N/A
	<b>Coconut</b>	Creamy off white	✓	N/A	N/A	N/A
	<b>Dover</b>	White with a taupe undertone	✓	N/A	N/A	N/A
	<b>Egret</b>	Light taupe with gray/green undertones	✓	✓	N/A	N/A
	<b>Icy Avalanche</b> 	Cool white with gray undertones	✓	N/A	N/A	N/A
	<b>Juniper Berry</b>	Pale antique blue	N/A	✓	✓	N/A
	<b>Lambswool</b>	Medium taupe	✓	✓	N/A	N/A
	<b>Limestone</b> 	Light gray	✓	✓	N/A	N/A
	<b>Maritime</b>	Dark navy with gray/green undertones	✓	✓	✓	N/A
	<b>Moonstone</b>	Cool dark gray	✓	✓	✓	N/A
	<b>Seaside</b>	Turquoise blue	N/A	✓	✓	N/A
	<b>White</b>	Bright, pure white	✓	N/A	N/A	N/A
Paints with Glazes*	<b>Amaretto Crème</b>	Dark brown glaze available on Cloud, Coconut, Dover, Egret, Icy Avalanche, Lambswool, Limestone, Maritime, and Moonstone.	✓	✓	✓**	N/A
	<b>Grey Stone</b>	Gray glaze available on Cloud, Coconut, Dover, Egret, Icy Avalanche, Lambswool, Limestone, and Maritime.	✓	✓	✓**	N/A
	<b>Juniper Berry w/Tidal Mist</b>	A two tone finish, applying a pale antique blue paint finish enhanced with a light brown glaze.	N/A	✓	✓	N/A
	<b>Seaside w/Oasis</b>	A two toned finish, applying a turquoise blue paint finish enhanced with a coffee colored glaze.	N/A	✓	✓	N/A
	<b>Toasted Almond</b>	Medium brown glaze available on Cloud, Coconut, Dover, Egret, Icy Avalanche, Lambswool, Limestone, Maritime, and Moonstone.	✓	✓	✓**	N/A

<sup>^</sup>In Distinction construction, cabinets will have matching laminate ends. Where not available, ends will be Natural Maple laminate and a finished end treatment would be needed for an exposed end.

\*On wood products, normal movement is typical due to change in climatic conditions. This will cause hairline cracks at stile, rail and panel joints. This hairline cracking is a normal characteristic of painted finishes and will not be considered a reason for product replacement. Finish agreement required, see page 441.

\*\*Available on Maritime and Moonstone only.

UNFINISHED			
OPTION NAME	DESCRIPTION/LIMITATIONS	DISTRESSING AVAILABILITY	HEIRLOOMING AVAILABILITY
<b>Unfinished</b>	Must upgrade to PE or APC. When cabinets are finished by an outside source, finish is not covered under warranty. Interiors of cabinets will be Natural Maple laminate for PE and clear coated veneer for APC. For finishable interiors, MIP must be specified.	✓	N/A





FINISH TECHNIQUES	
OPTION NAME	DESCRIPTION
<b>Distressing</b>	Provides a rustic look through the carefully crafted application of distressing characteristics such as dents, wormholes, chisel marks, and other signs of wear on solid-wood doors, drawer fronts, face frames, and <b>selected</b> trim items (veneer parts will not be distressed). The distressing technique creates a finish with unique and appealing imperfections, similar to those of time-worn antiques. Distressing characteristics are more visible with glaze finishes (face frames and trim items without detailed profiles will not feature glaze hang-up on distressed areas). Not available to order with Coconut, Dover, Icy Avalanche, and White. Not available on MDF.
<b>Heirlooming</b>	Available on select finishes. The finish will be sanded through the base coat to expose the surface of the wood. This type of sand through on the edges and profiles creates a naturally worn appearance. If a finish is chosen with a glaze, the glaze will be applied after the sanding has been done. This will enhance those areas of exposed wood to take on the darker characteristic of the applied glaze. Not available on Bailey, Monterey, and Trystan.  Select trim pieces will feature Heirlooming characteristics. See Trim section for availability.

SHEEN OPTION	
OPTION NAME	DESCRIPTION
<b>Matte Sheen</b> 	Available on Stains and Stains with Glazes.  Replaces standard top coat with a low sheen, non-pigmented top coat on doors, drawer fronts, face frames, trim items, and veneer finished cabinet components in selected finish. Does not affect laminate or clear finished components.

# FINISH AVAILABILITY

28

FINISH

		MAPLE																													
		Matching Laminate Ends <sup>▲</sup>	Heirloom <sup>*</sup>	Matte Sheen 	Anden	Bailey	Breman	Caldera	Crاندall	Cullen	Davis	Evans	Hanlon	Julien	LaGrange	Laureldale	Leeton	Liberty	Monterey	Montgomery	Perkins	Ridgefield	Rothshire	Selena	Shiloh	Sullivan	Summer	Trystan	Wells		
Stains	Brierwood	✓		✓	✓	✓	✓	✓	✓	✓	✓	✓	✓	✓	✓	✓	✓	✓	✓	✓	✓	✓	✓	✓	✓	✓	✓	✓	✓		
	Buckskin	✓		✓	✓	✓	✓	✓	✓	✓	✓	✓	✓	✓	✓	✓	✓	✓	✓	✓	✓	✓	✓	✓	✓	✓	✓	✓	✓		
	Cattail	✓		✓	✓	✓	✓	✓	✓	✓	✓	✓	✓	✓	✓	✓	✓	✓	✓	✓	✓	✓	✓	✓	✓	✓	✓	✓	✓		
	Chocolate	✓		✓	✓	✓	✓	✓	✓	✓	✓	✓	✓	✓	✓	✓	✓	✓	✓	✓	✓	✓	✓	✓	✓	✓	✓	✓	✓		
	Cranberry	✓		✓	✓	✓	✓	✓	✓	✓	✓	✓	✓	✓	✓	✓	✓	✓	✓	✓	✓	✓	✓	✓	✓	✓	✓	✓	✓		
	Grizzly	✓		✓	✓	✓	✓	✓	✓	✓	✓	✓	✓	✓	✓	✓	✓	✓	✓	✓	✓	✓	✓	✓	✓	✓	✓	✓	✓	✓	
	Havana	✓		✓	✓	✓	✓	✓	✓	✓	✓	✓	✓	✓	✓	✓	✓	✓	✓	✓	✓	✓	✓	✓	✓	✓	✓	✓	✓	✓	
	Henna	✓		✓	✓	✓	✓	✓	✓	✓	✓	✓	✓	✓	✓	✓	✓	✓	✓	✓	✓	✓	✓	✓	✓	✓	✓	✓	✓	✓	✓
	Kodiak	✓		✓	✓	✓	✓	✓	✓	✓	✓	✓	✓	✓	✓	✓	✓	✓	✓	✓	✓	✓	✓	✓	✓	✓	✓	✓	✓	✓	✓
	Morel	✓		✓	✓	✓	✓	✓	✓	✓	✓	✓	✓	✓	✓	✓	✓	✓	✓	✓	✓	✓	✓	✓	✓	✓	✓	✓	✓	✓	✓
	Natural	✓		✓	✓	✓	✓	✓	✓	✓	✓	✓	✓	✓	✓	✓	✓	✓	✓	✓	✓	✓	✓	✓	✓	✓	✓	✓	✓	✓	✓
	Sahara	✓		✓	✓	✓	✓	✓	✓	✓	✓	✓	✓	✓	✓	✓	✓	✓	✓	✓	✓	✓	✓	✓	✓	✓	✓	✓	✓	✓	✓
	Seal	✓		✓	✓	✓	✓	✓	✓	✓	✓	✓	✓	✓	✓	✓	✓	✓	✓	✓	✓	✓	✓	✓	✓	✓	✓	✓	✓	✓	✓
	Storm	✓	✓	✓	✓	✓	✓	✓	✓	✓	✓	✓	✓	✓	✓	✓	✓	✓	✓	✓	✓	✓	✓	✓	✓	✓	✓	✓	✓	✓	✓
	Thatch	✓		✓	✓	✓	✓	✓	✓	✓	✓	✓	✓	✓	✓	✓	✓	✓	✓	✓	✓	✓	✓	✓	✓	✓	✓	✓	✓	✓	✓
	Tundra	✓		✓	✓	✓	✓	✓	✓	✓	✓	✓	✓	✓	✓	✓	✓	✓	✓	✓	✓	✓	✓	✓	✓	✓	✓	✓	✓	✓	✓
Unfinished	✓				✓	✓	✓	✓	✓	✓	✓	✓	✓	✓	✓	✓	✓	✓	✓	✓	✓	✓	✓	✓	✓	✓	✓	✓	✓		
Stains with Glazes	Black Forest	✓		✓	✓	✓	✓	✓	✓	✓	✓	✓	✓	✓	✓	✓	✓	✓	✓	✓	✓	✓	✓	✓	✓	✓	✓	✓	✓		
	Coffee	✓		✓	✓	✓	✓	✓	✓	✓	✓	✓	✓	✓	✓	✓	✓	✓	✓	✓	✓	✓	✓	✓	✓	✓	✓	✓	✓		
	Palomino	✓		✓	✓	✓	✓	✓	✓	✓	✓	✓	✓	✓	✓	✓	✓	✓	✓	✓	✓	✓	✓	✓	✓	✓	✓	✓	✓		
	Whiskey Black	✓		✓	✓	✓	✓	✓	✓	✓	✓	✓	✓	✓	✓	✓	✓	✓	✓	✓	✓	✓	✓	✓	✓	✓	✓	✓	✓		
Paints 	Black		✓		✓	✓	✓	✓	✓	✓	✓	✓	✓	✓	✓	✓	✓	✓	✓	✓	✓	✓	✓	✓	✓	✓	✓	✓	✓		
	Cloud	✓			✓	✓	✓	✓	✓	✓	✓	✓	✓	✓	✓	✓	✓	✓	✓	✓	✓	✓	✓	✓	✓	✓	✓	✓	✓		
	Coconut	✓			✓	✓	✓	✓	✓	✓	✓	✓	✓	✓	✓	✓	✓	✓	✓	✓	✓	✓	✓	✓	✓	✓	✓	✓	✓		
	Dover	✓			✓	✓	✓	✓	✓	✓	✓	✓	✓	✓	✓	✓	✓	✓	✓	✓	✓	✓	✓	✓	✓	✓	✓	✓	✓		
	Egret	✓			✓	✓	✓	✓	✓	✓	✓	✓	✓	✓	✓	✓	✓	✓	✓	✓	✓	✓	✓	✓	✓	✓	✓	✓	✓		
	Icy Avalanche 	✓			✓	✓	✓	✓	✓	✓	✓	✓	✓	✓	✓	✓	✓	✓	✓	✓	✓	✓	✓	✓	✓	✓	✓	✓	✓	✓	
	Juniper Berry		✓		✓	✓	✓	✓	✓	✓	✓	✓	✓	✓	✓	✓	✓	✓	✓	✓	✓	✓	✓	✓	✓	✓	✓	✓	✓		
	Lambswool	✓			✓	✓	✓	✓	✓	✓	✓	✓	✓	✓	✓	✓	✓	✓	✓	✓	✓	✓	✓	✓	✓	✓	✓	✓	✓	✓	
	Limestone 	✓			✓	✓	✓	✓	✓	✓	✓	✓	✓	✓	✓	✓	✓	✓	✓	✓	✓	✓	✓	✓	✓	✓	✓	✓	✓	✓	✓
	Maritime	✓	✓		✓	✓	✓	✓	✓	✓	✓	✓	✓	✓	✓	✓	✓	✓	✓	✓	✓	✓	✓	✓	✓	✓	✓	✓	✓	✓	✓
	Moonstone	✓	✓		✓	✓	✓	✓	✓	✓	✓	✓	✓	✓	✓	✓	✓	✓	✓	✓	✓	✓	✓	✓	✓	✓	✓	✓	✓	✓	✓
	Seaside		✓		✓	✓	✓	✓	✓	✓	✓	✓	✓	✓	✓	✓	✓	✓	✓	✓	✓	✓	✓	✓	✓	✓	✓	✓	✓	✓	✓
	White	✓			✓	✓	✓	✓	✓	✓	✓	✓	✓	✓	✓	✓	✓	✓	✓	✓	✓	✓	✓	✓	✓	✓	✓	✓	✓	✓	✓







\*Heirloom not available on Bailey, Monterey, and Trystan.

▲ In Distinction construction, cabinets will have matching laminate ends. Where not available, ends will be Natural Maple laminate and a finished end treatment would be needed for an exposed end.

† Distressing not available on Coconut, Dover, Icy Avalanche, or White.

 Signed finish agreement required, see pages 440-442.

# FINISH AVAILABILITY

		MAPLE																											
		Matching Laminate Ends <sup>▲</sup>	Heirloom <sup>*</sup>	Anden	Bailey	Brenan	Caldera	Crandall	Cullen	Davis	Evans	Hamlon	Julien	LaGrange	Laureldale	Leeton	Liberty	Monterey	Montgomery	Perkins	Ridgetfield	Rothshire	Selena	Shiloh	Sullivan	Summer	Trystan	Wells	
Paints with Glazes	Cloud w/Amaretto Crème	✓		✓	✓	✓	✓	✓	✓	✓	✓	✓	✓	✓	✓	✓	✓	✓	✓	✓	✓	✓	✓	✓	✓	✓	✓	✓	
	Cloud w/Grey Stone	✓		✓	✓	✓	✓	✓	✓	✓	✓	✓	✓	✓	✓	✓	✓	✓	✓	✓	✓	✓	✓	✓	✓	✓	✓	✓	
	Cloud w/Toasted Almond	✓		✓	✓	✓	✓	✓	✓	✓	✓	✓	✓	✓	✓	✓	✓	✓	✓	✓	✓	✓	✓	✓	✓	✓	✓	✓	
	Coconut w/Amaretto Crème	✓		✓	✓	✓	✓	✓	✓	✓	✓	✓	✓	✓	✓	✓	✓	✓	✓	✓	✓	✓	✓	✓	✓	✓	✓	✓	
	Coconut w/Grey Stone	✓		✓	✓	✓	✓	✓	✓	✓	✓	✓	✓	✓	✓	✓	✓	✓	✓	✓	✓	✓	✓	✓	✓	✓	✓	✓	
	Coconut w/Toasted Almond	✓		✓	✓	✓	✓	✓	✓	✓	✓	✓	✓	✓	✓	✓	✓	✓	✓	✓	✓	✓	✓	✓	✓	✓	✓	✓	
	Dover w/Amaretto Crème	✓		✓	✓	✓	✓	✓	✓	✓	✓	✓	✓	✓	✓	✓	✓	✓	✓	✓	✓	✓	✓	✓	✓	✓	✓	✓	
	Dover w/Grey Stone	✓		✓	✓	✓	✓	✓	✓	✓	✓	✓	✓	✓	✓	✓	✓	✓	✓	✓	✓	✓	✓	✓	✓	✓	✓	✓	✓
	Dover w/Toasted Almond	✓		✓	✓	✓	✓	✓	✓	✓	✓	✓	✓	✓	✓	✓	✓	✓	✓	✓	✓	✓	✓	✓	✓	✓	✓	✓	✓
	Egret w/Amaretto Crème	✓		✓	✓	✓	✓	✓	✓	✓	✓	✓	✓	✓	✓	✓	✓	✓	✓	✓	✓	✓	✓	✓	✓	✓	✓	✓	✓
	Egret w/Grey Stone	✓		✓	✓	✓	✓	✓	✓	✓	✓	✓	✓	✓	✓	✓	✓	✓	✓	✓	✓	✓	✓	✓	✓	✓	✓	✓	✓
	Egret w/Toasted Almond	✓		✓	✓	✓	✓	✓	✓	✓	✓	✓	✓	✓	✓	✓	✓	✓	✓	✓	✓	✓	✓	✓	✓	✓	✓	✓	✓
	Icy Avalanche w/Amaretto Crème 	✓		✓	✓	✓	✓	✓	✓	✓	✓	✓	✓	✓	✓	✓	✓	✓	✓	✓	✓	✓	✓	✓	✓	✓	✓	✓	✓
	Icy Avalanche w/Grey Stone 	✓		✓	✓	✓	✓	✓	✓	✓	✓	✓	✓	✓	✓	✓	✓	✓	✓	✓	✓	✓	✓	✓	✓	✓	✓	✓	✓
	Icy Avalanche w/Toasted Almond 	✓		✓	✓	✓	✓	✓	✓	✓	✓	✓	✓	✓	✓	✓	✓	✓	✓	✓	✓	✓	✓	✓	✓	✓	✓	✓	✓
	Juniper Berry w/Tidal Mist		✓	✓	✓	✓	✓	✓	✓	✓	✓	✓	✓	✓	✓	✓	✓	✓	✓	✓	✓	✓	✓	✓	✓	✓	✓	✓	✓
	Lambswool w/Amaretto Crème	✓		✓	✓	✓	✓	✓	✓	✓	✓	✓	✓	✓	✓	✓	✓	✓	✓	✓	✓	✓	✓	✓	✓	✓	✓	✓	✓
	Lambswool w/Grey Stone	✓		✓	✓	✓	✓	✓	✓	✓	✓	✓	✓	✓	✓	✓	✓	✓	✓	✓	✓	✓	✓	✓	✓	✓	✓	✓	✓
	Lambswool w/Toasted Almond	✓		✓	✓	✓	✓	✓	✓	✓	✓	✓	✓	✓	✓	✓	✓	✓	✓	✓	✓	✓	✓	✓	✓	✓	✓	✓	✓
	Limestone w/Amaretto Crème 	✓		✓	✓	✓	✓	✓	✓	✓	✓	✓	✓	✓	✓	✓	✓	✓	✓	✓	✓	✓	✓	✓	✓	✓	✓	✓	✓
	Limestone w/Grey Stone 	✓		✓	✓	✓	✓	✓	✓	✓	✓	✓	✓	✓	✓	✓	✓	✓	✓	✓	✓	✓	✓	✓	✓	✓	✓	✓	✓
	Limestone w/Toasted Almond 	✓		✓	✓	✓	✓	✓	✓	✓	✓	✓	✓	✓	✓	✓	✓	✓	✓	✓	✓	✓	✓	✓	✓	✓	✓	✓	✓
	Maritime w/Amaretto Crème	✓	✓	✓	✓	✓	✓	✓	✓	✓	✓	✓	✓	✓	✓	✓	✓	✓	✓	✓	✓	✓	✓	✓	✓	✓	✓	✓	✓
	Maritime w/Grey Stone	✓	✓	✓	✓	✓	✓	✓	✓	✓	✓	✓	✓	✓	✓	✓	✓	✓	✓	✓	✓	✓	✓	✓	✓	✓	✓	✓	✓
	Maritime w/Toasted Almond	✓	✓	✓	✓	✓	✓	✓	✓	✓	✓	✓	✓	✓	✓	✓	✓	✓	✓	✓	✓	✓	✓	✓	✓	✓	✓	✓	✓
	Moonstone w/Amaretto Crème	✓	✓	✓	✓	✓	✓	✓	✓	✓	✓	✓	✓	✓	✓	✓	✓	✓	✓	✓	✓	✓	✓	✓	✓	✓	✓	✓	✓
Moonstone w/Toasted Almond	✓	✓	✓	✓	✓	✓	✓	✓	✓	✓	✓	✓	✓	✓	✓	✓	✓	✓	✓	✓	✓	✓	✓	✓	✓	✓	✓	✓	
Seaside w/Oasis		✓	✓	✓	✓	✓	✓	✓	✓	✓	✓	✓	✓	✓	✓	✓	✓	✓	✓	✓	✓	✓	✓	✓	✓	✓	✓	✓	
<b>Distressing Technique</b>	<b>Distressing</b>			✓ <sup>†</sup>				✓ <sup>†</sup>		✓ <sup>†</sup>	✓ <sup>†</sup>				✓ <sup>†</sup>								✓ <sup>†</sup>		✓ <sup>†</sup>				

\*Heirloom not available on Bailey, Monterey, and Trystan.

▲In Distinction construction, cabinets will have matching laminate ends. Where not available, ends will be Natural Maple laminate and a finished end treatment would be needed for an exposed end.

†Distressing not available on Coconut, Dover, Icy Avalanche, or White.

📄 Signed finish agreement required, see pages 440-442.

# FINISH AVAILABILITY

MDF 

	Matching Laminate Ends <sup>▲</sup>	Breman	Caldera	Montgomery	Trystan
<b>Black</b>		✓	✓	✓	✓
<b>Cloud</b>	✓	✓	✓	✓	✓
<b>Coconut</b>	✓	✓	✓	✓	✓
<b>Dover</b>	✓	✓	✓	✓	✓
<b>Egret</b>	✓	✓	✓	✓	✓
 <b>Icy Avalanche</b>	✓	✓	✓	✓	✓
<b>Juniper Berry</b>		✓	✓	✓	✓
<b>Lambswool</b>	✓	✓	✓	✓	✓
<b>Limestone</b>	✓	✓	✓	✓	✓
<b>Maritime</b>	✓	✓	✓	✓	✓
<b>Moonstone</b>	✓	✓	✓	✓	✓
<b>Seaside</b>		✓	✓	✓	✓
<b>White</b>	✓	✓	✓	✓	✓

<sup>▲</sup>In Distinction construction, cabinets will have matching laminate ends. Where not available, ends will be Natural Maple laminate and a finished end treatment would be needed for an exposed end.

 Signed finish agreement required, see pages 440-442.



## FINISH AVAILABILITY

		CHERRY																												
		Matching Laminate Ends*	Heirlooming*	Matte Sheen	Bailey	Breman	Caldera	Crاندall	Cullen	Davis	Evans	Hanlon	Julien	LaGrange	Laureldale	Leeton	Liberty	Monterey	Montgomery	Perkins	Ridgefield	Rothshire	Selena	Shloh	Sullivan	Summer	Trystan	Wells		
Stains	Brierwood	✓		✓	✓	✓	✓	✓	✓	✓	✓	✓	✓	✓	✓	✓	✓	✓	✓	✓	✓	✓	✓	✓	✓	✓	✓	✓		
	Buckskin	✓		✓	✓	✓	✓	✓	✓	✓	✓	✓	✓	✓	✓	✓	✓	✓	✓	✓	✓	✓	✓	✓	✓	✓	✓	✓		
	Cattail	✓		✓	✓	✓	✓	✓	✓	✓	✓	✓	✓	✓	✓	✓	✓	✓	✓	✓	✓	✓	✓	✓	✓	✓	✓	✓		
	Chocolate	✓		✓	✓	✓	✓	✓	✓	✓	✓	✓	✓	✓	✓	✓	✓	✓	✓	✓	✓	✓	✓	✓	✓	✓	✓	✓		
	Cranberry	✓		✓	✓	✓	✓	✓	✓	✓	✓	✓	✓	✓	✓	✓	✓	✓	✓	✓	✓	✓	✓	✓	✓	✓	✓	✓		
	Grizzly	✓		✓	✓	✓	✓	✓	✓	✓	✓	✓	✓	✓	✓	✓	✓	✓	✓	✓	✓	✓	✓	✓	✓	✓	✓	✓	✓	
	Havana	✓		✓	✓	✓	✓	✓	✓	✓	✓	✓	✓	✓	✓	✓	✓	✓	✓	✓	✓	✓	✓	✓	✓	✓	✓	✓	✓	
	Henna	✓		✓	✓	✓	✓	✓	✓	✓	✓	✓	✓	✓	✓	✓	✓	✓	✓	✓	✓	✓	✓	✓	✓	✓	✓	✓	✓	✓
	Kodiak	✓		✓	✓	✓	✓	✓	✓	✓	✓	✓	✓	✓	✓	✓	✓	✓	✓	✓	✓	✓	✓	✓	✓	✓	✓	✓	✓	✓
	Light	✓		✓	✓	✓	✓	✓	✓	✓	✓	✓	✓	✓	✓	✓	✓	✓	✓	✓	✓	✓	✓	✓	✓	✓	✓	✓	✓	✓
	Morel	✓		✓	✓	✓	✓	✓	✓	✓	✓	✓	✓	✓	✓	✓	✓	✓	✓	✓	✓	✓	✓	✓	✓	✓	✓	✓	✓	✓
	Natural	✓		✓	✓	✓	✓	✓	✓	✓	✓	✓	✓	✓	✓	✓	✓	✓	✓	✓	✓	✓	✓	✓	✓	✓	✓	✓	✓	✓
	Sahara	✓		✓	✓	✓	✓	✓	✓	✓	✓	✓	✓	✓	✓	✓	✓	✓	✓	✓	✓	✓	✓	✓	✓	✓	✓	✓	✓	✓
	Seal	✓		✓	✓	✓	✓	✓	✓	✓	✓	✓	✓	✓	✓	✓	✓	✓	✓	✓	✓	✓	✓	✓	✓	✓	✓	✓	✓	✓
	Storm		✓	✓	✓	✓	✓	✓	✓	✓	✓	✓	✓	✓	✓	✓	✓	✓	✓	✓	✓	✓	✓	✓	✓	✓	✓	✓	✓	✓
	Thatch	✓		✓	✓	✓	✓	✓	✓	✓	✓	✓	✓	✓	✓	✓	✓	✓	✓	✓	✓	✓	✓	✓	✓	✓	✓	✓	✓	✓
Tundra	✓		✓	✓	✓	✓	✓	✓	✓	✓	✓	✓	✓	✓	✓	✓	✓	✓	✓	✓	✓	✓	✓	✓	✓	✓	✓	✓	✓	
Unfinished	✓			✓	✓	✓	✓	✓	✓	✓	✓	✓	✓	✓	✓	✓	✓	✓	✓	✓	✓	✓	✓	✓	✓	✓	✓	✓	✓	
Stains with Glazes	Black Forest	✓		✓	✓	✓	✓	✓	✓	✓	✓	✓	✓	✓	✓	✓	✓	✓	✓	✓	✓	✓	✓	✓	✓	✓	✓	✓	✓	
	Coffee	✓		✓	✓	✓	✓	✓	✓	✓	✓	✓	✓	✓	✓	✓	✓	✓	✓	✓	✓	✓	✓	✓	✓	✓	✓	✓	✓	
	Palomino	✓		✓	✓	✓	✓	✓	✓	✓	✓	✓	✓	✓	✓	✓	✓	✓	✓	✓	✓	✓	✓	✓	✓	✓	✓	✓	✓	
	Whiskey Black	✓		✓	✓	✓	✓	✓	✓	✓	✓	✓	✓	✓	✓	✓	✓	✓	✓	✓	✓	✓	✓	✓	✓	✓	✓	✓	✓	
Distressing Technique	Distressing							✓		✓	✓				✓								✓		✓					



\*Heirlooming not available on Bailey, Monterey, and Trystan.

▲In Distinction construction, cabinets will have matching laminate ends. Where not available, ends will be Natural Maple laminate and a finished end treatment would be needed for an exposed end.

☞ Signed finish agreement required, see pages 440-442.

Cherry laminate sides are intentionally 15-20% darker than face frames and doors at the time of manufacture to compensate for the expected darkening of face frames, doors, etc., as they are exposed to natural sunlight.

## FINISH AVAILABILITY

					ALDER						RUSTIC ALDER 						
		Matching Laminate Ends <sup>▲</sup>	Heirlooming 	Matte Sheen 	Breman	Carson	Crandall	Montgomery	Selena	Shiloh	Summer	Breman	Carson	Crandall	Montgomery	Shiloh	Summer
Stains	Brierwood	✓		✓	✓	✓	✓	✓	✓	✓	✓	✓	✓	✓	✓	✓	✓
	Buckskin	✓		✓	✓	✓	✓	✓	✓	✓	✓	✓	✓	✓	✓	✓	✓
	Cattail	✓		✓	✓	✓	✓	✓	✓	✓	✓	✓	✓	✓	✓	✓	✓
	Chocolate	✓		✓	✓	✓	✓	✓	✓	✓	✓	✓	✓	✓	✓	✓	✓
	Cranberry	✓		✓	✓	✓	✓	✓	✓	✓	✓	✓	✓	✓	✓	✓	✓
	Grizzly	✓		✓	✓	✓	✓	✓	✓	✓	✓	✓	✓	✓	✓	✓	✓
	Havana	✓		✓	✓	✓	✓	✓	✓	✓	✓	✓	✓	✓	✓	✓	✓
	Kodiak	✓		✓	✓	✓	✓	✓	✓	✓	✓	✓	✓	✓	✓	✓	✓
	Morel	✓		✓	✓	✓	✓	✓	✓	✓	✓	✓	✓	✓	✓	✓	✓
	Natural	✓		✓	✓	✓	✓	✓	✓	✓	✓	✓	✓	✓	✓	✓	✓
	Sahara	✓		✓	✓	✓	✓	✓	✓	✓	✓	✓	✓	✓	✓	✓	✓
	Seal	✓		✓	✓	✓	✓	✓	✓	✓	✓	✓	✓	✓	✓	✓	✓
	Thatch	✓		✓	✓	✓	✓	✓	✓	✓	✓	✓	✓	✓	✓	✓	✓
	Tundra	✓		✓	✓	✓	✓	✓	✓	✓	✓	✓	✓	✓	✓	✓	✓
Unfinished	✓			✓	✓	✓	✓	✓	✓	✓	✓	✓	✓	✓	✓	✓	
Stains with Glazes	Black Forest	✓		✓	✓	✓	✓	✓	✓	✓	✓	✓	✓	✓	✓	✓	
	Coffee	✓		✓	✓	✓	✓	✓	✓	✓	✓	✓	✓	✓	✓	✓	
	Palomino	✓		✓	✓	✓	✓	✓	✓	✓	✓	✓	✓	✓	✓	✓	
	Whiskey Black	✓		✓	✓	✓	✓	✓	✓	✓	✓	✓	✓	✓	✓	✓	
Distressing Technique	Distressing					✓	✓		✓				✓	✓			

<sup>▲</sup>In Distinction construction, cabinets will have matching laminate ends. Where not available, ends will be Natural Maple laminate and a finished end treatment would be needed for an exposed end.  
 Signed finish agreement required, see pages 440-442.

## FINISH AVAILABILITY

					HICKORY				OAK						
		Matching Laminate Ends <sup>▲</sup>	Heirloom <sup>*</sup>	Matte Sheen <sup>NEW</sup>	Crandall	Evans	Montgomery	Perkins	Breman	Crandall	Evans	Monterey	Perkins	Ridgefield	Summer
Stains	Brierwood	✓		✓	✓	✓	✓	✓	✓	✓	✓	✓	✓	✓	✓
	Buckskin	✓		✓	✓	✓	✓	✓	✓	✓	✓	✓	✓	✓	✓
	Chocolate	✓		✓					✓	✓	✓	✓	✓	✓	✓
	Grizzly	✓		✓	✓	✓	✓	✓	✓	✓	✓	✓	✓	✓	✓
	Havana	✓		✓	✓	✓	✓	✓	✓	✓	✓	✓	✓	✓	✓
	Kodiak	✓		✓	✓	✓	✓	✓	✓	✓	✓	✓	✓	✓	✓
	Light	✓		✓	✓	✓	✓	✓	✓	✓	✓	✓	✓	✓	✓
	Morel	✓		✓	✓	✓	✓	✓	✓	✓	✓	✓	✓	✓	✓
	Natural	✓		✓	✓	✓	✓	✓	✓	✓	✓	✓	✓	✓	✓
	Sahara	✓		✓	✓	✓	✓	✓	✓	✓	✓	✓	✓	✓	✓
	Seal	✓		✓	✓	✓	✓	✓	✓	✓	✓	✓	✓	✓	✓
	Thatch	✓		✓	✓	✓	✓	✓	✓	✓	✓	✓	✓	✓	✓
	Tundra	✓		✓	✓	✓	✓	✓	✓	✓	✓	✓	✓	✓	✓
	Unfinished	✓			✓	✓	✓	✓	✓	✓	✓	✓	✓	✓	✓
Stains with Glazes	Black Forest	✓		✓					✓	✓	✓	✓	✓	✓	✓
	Coffee	✓		✓	✓	✓	✓								
	Palomino	✓		✓				✓	✓	✓	✓	✓	✓	✓	
Paints	Black 		✓						✓	✓	✓	✓	✓	✓	✓
Distressing Technique	Distressing				✓	✓				✓	✓				

\*Available on Oak only.

▲In Distinction construction, cabinets will have matching laminate ends. Where not available, ends will be Natural Maple laminate and a finished end treatment would be needed for an exposed end.

 Signed finish agreement required, see pages 440-442.

## FINISH AVAILABILITY

DOOR COLOR AVAILABILITY		PURESTYLE™	SPECIALTY LAMINATES			THERMOFOIL
		Worthen	Graniti	Tranter	Wixom	Catalina
Non-Textured	Antler		✓			
	White					✓
Textured	Arctic			✓		
	Elk	✓	✓			
	Obsidian			✓		
	Wharf		✓			
High Gloss	White w/Matching Edgebanding				✓	
	White w/Metallic Edgebanding				✓	

CABINET COLOR AVAILABILITY		Matching Laminate Ends <sup>4</sup>	DOOR COLOR AVAILABILITY						
			Antler	Arctic	Elk	High Gloss White	Obsidian	Wharf	White
Stains	Morel Cherry	✓	✓						
	Morel Hickory	✓	✓						
	Morel Maple	✓	✓						
	Morel Oak	✓	✓						
	Seal Hickory	✓		✓					
	Seal Maple	✓		✓					
	Seal Oak	✓		✓					
	Storm Maple	✓				✓			
	Thatch Hickory	✓		✓					
	Thatch Maple	✓		✓					
	Thatch Oak	✓		✓					
Paints	Black					✓			
	Cloud	✓	✓	✓					
	Dover	✓	✓	✓			✓		
	Icy Avalanche 	✓		✓					
	Lambswool	✓	✓				✓		
	Limestone 	✓	✓				✓		
	White	✓	✓	✓	✓		✓	✓	✓

<sup>4</sup>In Distinction construction, cabinets will have matching laminate end to match the cabinet box color. Where not available, ends will be Natural Maple laminate and a finished end treatment would be needed for an exposed end.

## THINGS TO REMEMBER ABOUT FINISHED ENDS AND CABINET INTERIOR FINISHES

On cabinets with PLYWOOD ENDS (PE) or ALL-PLYWOOD CONSTRUCTION (APC) modifications, cabinet sides are plywood with an unfinished veneer exterior. You can finish the exposed ends in your kitchen with one of several decorative options, as follows:

1. Leave the ends UNFINISHED if the cabinets are installed against each other or against the wall.
2. Purchase a 1/4" VENEER SKIN for field installation. This brings the cabinet side flush with the face frame.
3. Specify FURNITURE FINISHED PLYWOOD ENDS (FPEB). See page 41 for details.
4. Specify AUTHENTIC ENDS (AUTHL or AUTHR) or Face Frame and Door on End (FFDL or FFDR). See page 41 for details.
5. Specify cabinets with FINISHED ENDS (FB), factory installed. Both ends of the cabinet use 1/2" plywood veneer panel that is factory finished on the exterior to match the door and frame.
6. Purchase Wall, Base or Tall END DECORATIVE DOOR PANELS (WED, BED, TED). These are a skin and a door that can be attached to finish the exposed end. This will extend the total cabinet run by the thickness of the door.
7. Purchase a Wall MESSAGE CENTER.
8. Cabinets specified with MIP have matching veneer interior and exterior. Some cabinets are provided with standard MIP construction, such as:
  - Wine Rack Cabinets
  - WOC - Wall Open Cabinets
  - Wall China Display Cabinets
  - Bookcase Cabinets
  - BOC, BOD - Base Open Cabinets
9. All Wall Organizer and Wall/Base Spice Drawer Cabinets are frameless doweled construction and feature 3/4" furniture board with matching finished veneer interior and exterior.

# CONSTRUCTION FEATURES

	DISTINCTION (DST)	PLYWOOD ENDS (PE)*	ALL-PLYWOOD CONSTRUCTION (APC)*
<b>Doors &amp; Drawer Fronts</b>	See "Door Styles" pages 10-25 for door and drawer front configuration and construction details.		
<b>Face Frames</b>	3/4" solid hardwood.		
<b>I-Beam Braces</b>	1/2" furniture board dadoed into face frame, end panels and back panels.		1/2" plywood dadoed into face frame, end panels and back panels.
<b>Cabinet Sides</b>	1/2" furniture board with Natural Maple laminate interiors. Exteriors are laminate that match the color of the face frame, with exception of Black, Juniper Berry, Juniper Berry w/Tidal Mist, Seaside, Seaside w/Oasis, and Cherry Storm.	1/2" unfinished veneer plywood with Natural Maple laminate interiors.	1/2" unfinished plywood with clear coated veneer interior.**▲
	Optional Furniture Finished Plywood Ends (FPPEB) modification: Cabinets will have 3/4" finished veneer end panels to achieve a Furniture End appearance. See page 41 for more details.		
<b>Cabinet Tops &amp; Bottoms</b>	1/2" furniture board with Natural Maple laminate interior and exterior surfaces.		1/2" plywood with clear coated veneer interior and exterior.**▲
<b>Cabinet Backs</b>	3/8" furniture board with Natural Maple laminate interior. Base cabinets have 3mm system holes for easy drawer and tray installation.		3/8" plywood with clear coated veneer interior.**▲ Base cabinets have 3mm system holes for easy drawer and tray installation.
<b>Adjustable Shelves</b>	3/4" furniture board with Natural Maple laminate to match interiors. Shelves are adjustable in wall and base cabinets unless otherwise noted.		3/4" plywood with clear coated veneer to match interiors.** Shelves are adjustable in wall and base cabinets.
<b>Finish</b>	Multi-step finishing process where the finished components are sanded, stained, and sealed before a catalyzed top coat is applied.		
<b>Hinges</b>	Quick-Release™ fully concealed, 6-way adjustable cup hinge features push tab for easy removal, deactivation option, and <b>Smart Stop™ self-closing feature</b> . Select cabinets feature a 170° or 107° 4-way adjustable hinge. See page 429 for details.		
<b>Drawer Box and Roll Tray Construction</b>	All Styles: Four-sided clear coated hardwood. Corners are dovetailed and glued. Drawer bottom is 5.2mm laminated plywood fully captured in box sides, front and back.		
<b>Drawer and Roll Tray Guide</b>	Double fully concealed, ball bearing, self-aligning, full extension guide with <b>Smart Stop™ self-closing mechanism</b> and fast clip removal system. Smart Stop engages when the drawer or roll tray is approximately 2" from closing, applying resistance to the self-closing mechanism. Optional (Roll Trays): EasyTrax™ (ET) height adjustment system. All guides have a maximum weight capacity of 90 lbs. Drawers and roll trays have a maximum weight capacity of 15 lbs. per square foot.		
<b>Toekick</b>	Unfinished furniture board toekick to allow application of finished toeboard materials. A variety of laminate and wood toeboard skins and baseboard mouldings available in 8' lengths; see ACCESSORIES section. When APC is selected, toekick will be plywood.		
<b>Warranty</b>	Diamond® Distinction™ Series has a Limited Lifetime Warranty. For terms and conditions, please visit: <a href="https://www.diamondcabinets.com/warranty">https://www.diamondcabinets.com/warranty</a> .		
<b>Interior Cabinet Components</b>	A few interior components are manufactured from laminated furniture board because they provide for the most durable, aesthetic application. Some examples include the BCFW48SP (swing-out shelf), SLS33/36 (fixed shelf), and PY18/36 (swing-out and door mounted racks).		

## DISTINCTION CABINET CONSTRUCTION

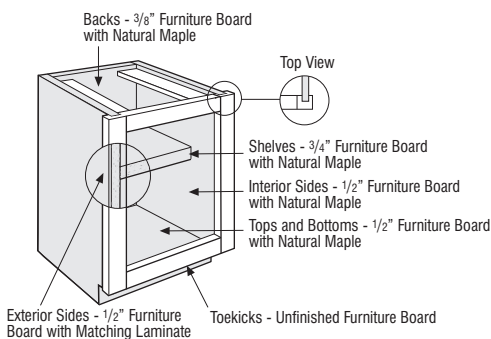

See page 38 for Plywood Ends and All-plywood Construction.

## DISTINCTION DRAWER CONSTRUCTION

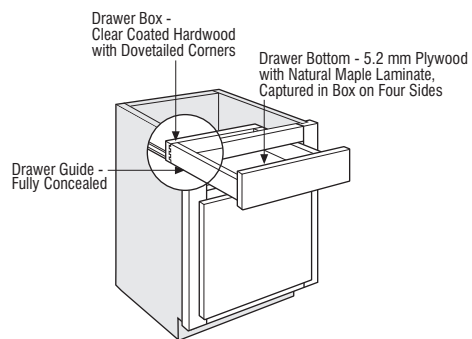

See page 38 for Plywood Ends and All-plywood Construction.

\*All-plywood components meet ANSI/HPVA HP-1 standards and may contain MDF or particleboard.

\*\*White Laminate Interior (WLI) modification is available on White cabinets to replace the clear coated veneer with White laminate.

▲ Cabinets with limited interior visibility, such as Drawer Bases (2DB., 3DB., 4DB.), appliance cabinets without doors, and others may have a laminated plywood cabinet interior.





# CONSTRUCTION UPGRADES

See page 37 for modification compatibility. Requests for non-published modifications may be treated as a Special Sales Order which will require feasibility, leadtime review and approval. Please check with your customer service representative before placing your order.

OPTION NAME	APPLICABLE CABINET GROUP	DESCRIPTION/LIMITATIONS
<b>Plywood Ends (PE)**</b>	Most cabinets with sides	Replaces standard cabinet ends with unfinished 1/2" plywood exterior ends. See page 36 for more details.
<b>All-plywood Construction (APC)**</b>	Most cabinets with sides	Replaces standard cabinet construction with plywood for 1/2" ends, top, bottom, 3/4" shelves, and 3/8" back. Exterior of cabinet ends are unfinished. Cabinet interior and exterior of top and bottom are clear coated veneer***. See page 36 for more details.  White Laminate Interior (WLI) modification available on White cabinets (painted White or Laminate) in APC, see page 42.
	Selected trim panels	Replaces standard panel material with plywood. Exterior side is finished. Interior side is clear coated veneer.

## PLYWOOD ENDS CONSTRUCTION UPGRADE (PE)

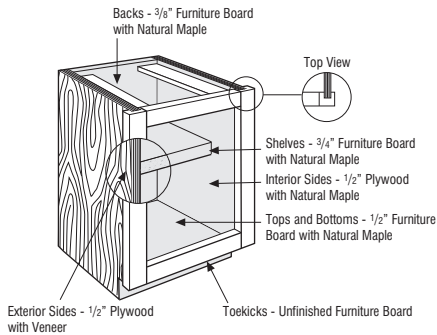

## ALL-PLYWOOD CONSTRUCTION UPGRADE (APC)

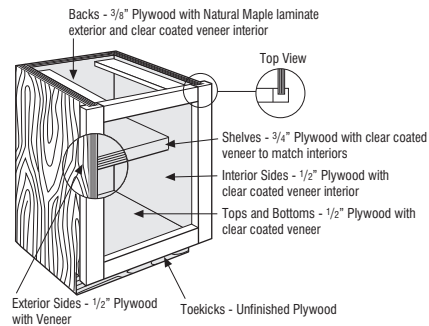

\*When a cabinet is specified with FPBE in a design where PE has been selected for the entire kitchen (through Styles & Pricing Tab and Construction Options menu), use attachments to specify PE for all other cabinets instead of selecting it for the entire kitchen.

\*\*All-plywood components meet ANSI/HPVA HP-1 standards and may contain MDF or particleboard.

\*\*\*Cabinets with limited interior visibility, such as Drawer Bases (2DB., 3DB., 4DB..), appliance cabinets without doors, and others may have a laminated plywood cabinet interior.

# DRAWER FRONT UPGRADES

See page 37 for modification compatibility. Requests for non-published modifications may be treated as a Special Sales Order which will require feasibility, leadtime review and approval. Please check with your customer service representative before placing your order.

OPTION NAME	APPLICABLE CABINET GROUP	DESCRIPTION/LIMITATIONS
<b>Drawer Front Flat 5-Piece (DFF5PC)</b>	Base, tall, and vanity cabinets on Bailey, Breman, Liberty, Selena, Shiloh, and Sumner.	Replaces the standard drawer front with a 5-piece drawer front (see images with applicable door styles). Must upgrade all drawer fronts on a cabinet where applicable. See page 77 for 5-piece drawer front dimensions when specifying decorative hardware.
<b>Drawer Front Raised 5-Piece (DFR5PC)</b>	Base, tall, and vanity cabinets on Carson and Sullivan	Replaces the standard drawer front with a 5-piece drawer front (see images with applicable door styles). Must upgrade all drawer fronts on a cabinet where applicable. See page 77 for 5-piece drawer front dimensions when specifying decorative hardware.
<b>Drawer Front Slab (DFS LB)</b>	Base, tall, and vanity cabinets on Anden, Caldera, Davis, Julien, Leeton, Montgomery, Sullivan, and Wells	Replaces standard drawer front with slab drawer front. Must upgrade all drawer fronts on cabinet where applicable.

### DRAWER FRONT FLAT 5-PIECE (DFF5PC)



Bailey

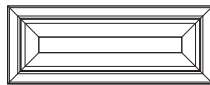

Selena\*

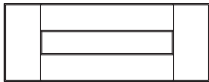

Breman

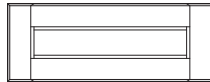

Shiloh

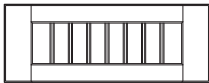

Liberty



Sumner

\*Selena 5-piece 6 1/4" and 6 3/4" high drawer fronts have a flat center panel, 10" and taller drawer fronts have a raised center panel.

### DRAWER FRONT RAISED 5-PIECE (DFR5PC)

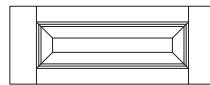

Carson

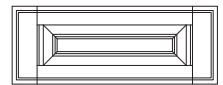

Sullivan

### DRAWER FRONT SLAB (DFS LB)



Anden  
Caldera  
Davis



Julien

Leeton  
Montgomery  
Wells



Sullivan

# DRAWER AND DOOR OPTIONS

See page 37 for modification compatibility. Requests for non-published modifications may be treated as a Special Sales Order which will require feasibility, leadtime review and approval. Please check with your customer service representative before placing your order.

OPTION NAME	APPLICABLE CABINET GROUP	DESCRIPTION/LIMITATIONS
<b>Door Panel - Solid Reverse Raised (DPSRR)</b>	Most cabinets with doors; available on Montgomery only	Replaces Montgomery veneer flat door center panel with a solid reverse raised center panel. Drawer fronts are not affected by this door option. Center panels in Paint and Paint with Glaze finishes will be reverse raised MDF.
<b>Modified Full Overlay (MFO)</b>	Most wall and tall cabinets and some panels with doors	Reduces the size of a Full Overlay door by 3/4" allowing for a top face frame reveal of 1" to allow for face mount moulding application. Overlay Fillers are available in MFO heights to align with doors, see pages 350-353 for OL..MFO and OL..MFOP. Not compatible with Add Toekick modification. When Authentic End(s) are ordered in conjunction with Modified Full Overlay, the Authentic End will match the face frame reveal. Not available on Aluminum Frame Doors. Not available on Catalina, Trystan, Worthen, and partial overlay styles. Not available on Selena mullion doors.
<b>Scooped Drawer (SCPDW) (SCPDRWB) (SCPDRWL) (SCPDRWR)</b>	Most base cabinets	Replaces top drawer box with a 2" high drawer box to allow for clearance of cooktops, etc. Only top drawer will be modified when specified on drawer bases. On base cabinets with two top drawers, L, R, or B must be specified. Increases clearance for cooktops from 2" to 3 7/8". When SCPDRW is selected on 2DB18-2DB42, top drawer will utilize a 6 3/8" high drawer box, creating a clearance of 6 5/8" for the cooktop. Not available on MDF or Worthen door styles.

## DOOR PANEL - SOLID REVERSE RAISED (DPSRR)



## MODIFIED FULL OVERLAY (MFO)

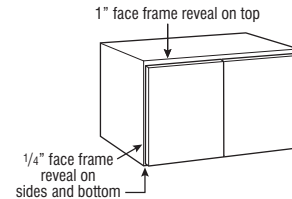

## SCOOPED DRAWER (SCPDW/SCPDRWB/SCPDRWL/SCPDRWR)

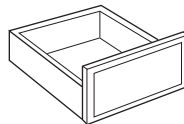

# END PANEL MODIFICATIONS

See page 37 for modification compatibility. Requests for non-published modifications may be treated as a Special Sales Order which will require feasibility, leadtime review and approval. Please check with your customer service representative before placing your order.

OPTION NAME	APPLICABLE CABINET GROUP	DESCRIPTION/LIMITATIONS
<b>Authentic Ends (AUTHL) (AUTHR)</b>	Most wall, base, tall, and vanity cabinets	<p>Modifies cabinet end panel(s) with applied decorative door(s) onto FPEB upgraded end panel(s).</p> <p>Includes FPEB modification — If AUTHL or AUTHR upgrades are specified, the opposite end panel is also FPEB.</p> <p>Available on most cabinets with depths of 9", 12", 15", 18", 21", 24" and 27". Custom doors must be specified for other depths not listed. 9" depth available on cabinets 30" high or taller.</p> <p>12" and 15" high wall cabinets will have double door configuration on 21" and 24" deep applications.</p> <p>For tall cabinets, non-miter doors have two panels on the bottom door.</p> <p>Decorative door for wall and tall cabinets will match style chosen on order, i.e., arch or square.</p> <p>27" deep cabinets and Floating Island Cabinets (FIC__, FICNT__ ) will have double door configuration. Office base cabinets (29" high) will have double door configuration when specified on 24" deep cabinets.</p>
<b>Face Frame and Door on End (FFDL) (FFDR)</b>	Most wall, base, tall, and vanity cabinets	<p>Creates a working door on the end of the specified cabinet. Opposite end panel will be FPEB.</p> <p>Side cabinet configuration will match front configuration.</p> <p>On Base and Tall cabinets, recessed toe space is standard on the side specified with FFDR or FFDL (if any flush toekick modification is specified, FFD side of cabinet will also be flush). 12" deep cabinets specified with FFDL or FFDR and FTKAV or FTKFV will receive a standard flush toekick.</p> <p>Full depth shelves standard. Glass shelves not compatible with the FFD modification.</p> <p>Doors will always be hinged on the back of the cabinet. Option not available on both ends of cabinet. Not available on peninsula cabinets. Available on cabinets in depths of 12", 15", 18", 21", and 24".</p> <p>If glass is specified, the FFD door will also be glass. When ordered with MD on 12" deep cabinets, the FFD door will be Cut-for-glass. When ordered with Mullion Doors on 39" or 42" high cabinets, adjustable shelves will not align with mullions.</p>
<b>Finished Ends (FB)</b>	Cabinets with PE or APC modification; both ends will be finished	Creates a matching finished 1/2" veneer plywood exterior.
<b>Furniture Finished Plywood* Ends (FPEB)</b>	Most wall, base, tall, office, and vanity cabinets	Replaces standard cabinet ends with 3/4" finished veneer end panels to achieve a Furniture End appearance. Both exterior sides are finished. Includes PE upgrade and standard laminate interior. Order APC for clear coated veneer interior. Matching Interior Plywood (MIP) is available.

## AUTHENTIC ENDS (AUTHL/AUTHR)

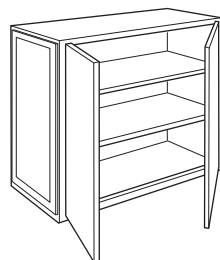

Wall cabinets

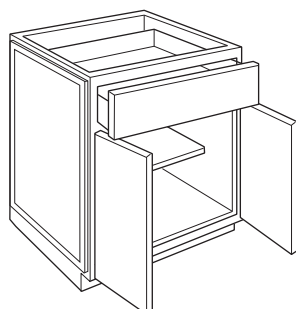

Base and Vanity cabinets

## FURNITURE FINISHED PLYWOOD ENDS (FPEB)

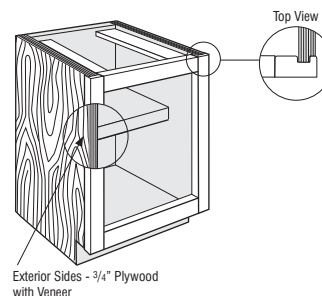

Exterior Sides - 3/4" Plywood with Veneer

## FACE FRAME AND DOOR ON END (FFDL/FFDR)

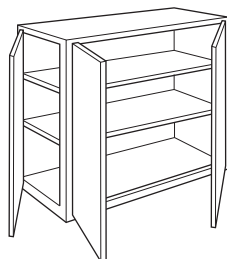

Wall cabinets

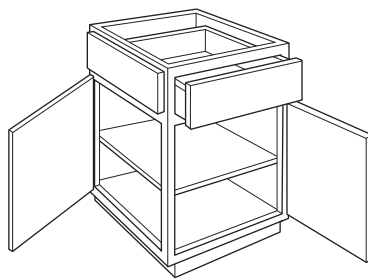

Base cabinets

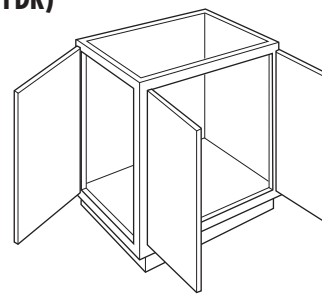

Vanity cabinets



\*All-plywood components meet ANSI/HPVA HP-1 standards and may contain MDF or particleboard.

# FINISH MODIFICATIONS

See page 37 for modification compatibility. Requests for non-published modifications may be treated as a Special Sales Order which will require feasibility, leadtime review and approval. Please check with your customer service representative before placing your order.

OPTION NAME	APPLICABLE CABINET GROUP	DESCRIPTION/LIMITATIONS
<b>Matching Interior Plywood (MIP)</b>	Most cabinets	Modifies the cabinet interior and end panel exterior to matching finished veneer plywood. Cabinet top and bottom exterior on wall and tall cabinets is matching finished veneer plywood.  Cabinet construction features 1/2" plywood ends, top, bottom, and 3/8" back. Shelves are upgraded to full depth 3/4" veneered plywood.  Interior wood accessories feature a natural finish and will not match cabinet exterior.  When a decorative door option is chosen in 20/20, Matching Interior Plywood (MIP) is a preselected option. If MIP is not desired, it can be deselected by choosing NOTMIP.
	Most end panels with fillers attached	Replaces standard panel material with veneer plywood finished on both sides.
<b>White Laminate Interior (WLI)</b>	White cabinets with APC	Replaces clear coated veneer plywood interior with White laminate plywood interior. Wall cabinet tops and bottoms will be white laminate. PFINBTMB is recommended for use when WLI cabinets are adjacent to cabinets with natural maple laminate or clear coated veneer cabinet bottoms. Finished Ends (FB) is recommended for matching finished veneer ends.  Only available on cabinets in White (painted Maple or Laminate) that are specified with APC.  WLI only affects the cabinet box interior and shelves, interior accessories will not change.

## MATCHING INTERIOR PLYWOOD (MIP)

-  matching finished veneer
-  standard matching finished component
-  standard non-matching finished component

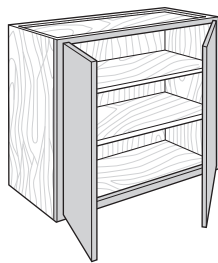

Wall cabinets

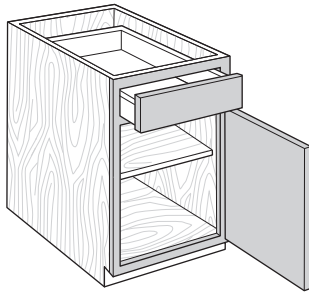

Base cabinets

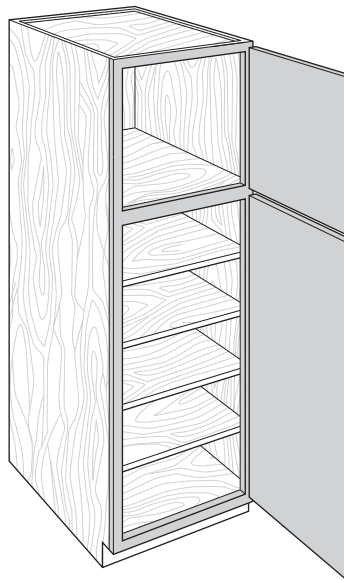

Tall cabinets

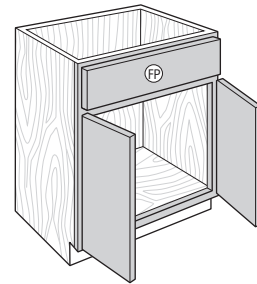

Vanity cabinets

## WHITE LAMINATE INTERIOR (WLI)

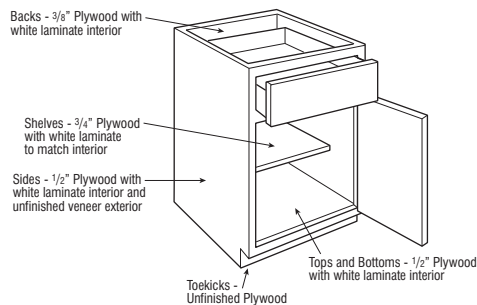



# BOX MODIFICATIONS

See page 37 for modification compatibility. Requests for non-published modifications may be treated as a Special Sales Order which will require feasibility, leadtime review and approval. Please check with your customer service representative before placing your order.

OPTION NAME	APPLICABLE CABINET GROUP	DESCRIPTION/LIMITATIONS
<b>Cabinet Box Only (CBO)</b>	Most wall, base, tall, and vanity cabinets	Removes doors, drawer fronts, and any accessory items attached to a door or drawer front. Drawer box and any interior components attached to the cabinet box will be included. Frames will not be drilled for hinges.
<b>Cabinet Case Only (CCO)</b>	Most wall, base, tall, and vanity cabinets	Removes doors, drawer fronts, drawer boxes, interior components, and mini touch-up kits. Frames will not be drilled for hinges, but cabinet will have standard drilling for shelves and guides.
<b>Cabinet False Panel (CFP)</b>	Most base and vanity cabinets with a top drawer	Replaces top drawer with false panel. Not available with deep drawers.
<b>Cabinet with No Door, with Drawer (CND)</b>	Most wall, base, tall, and vanity cabinets with door(s) and drawer(s)	Removes door(s). Complete drawer(s) with drawer front(s) and interior components remain in cabinet. Frames will not be drilled for hinges.

### CABINET BOX ONLY (CBO)

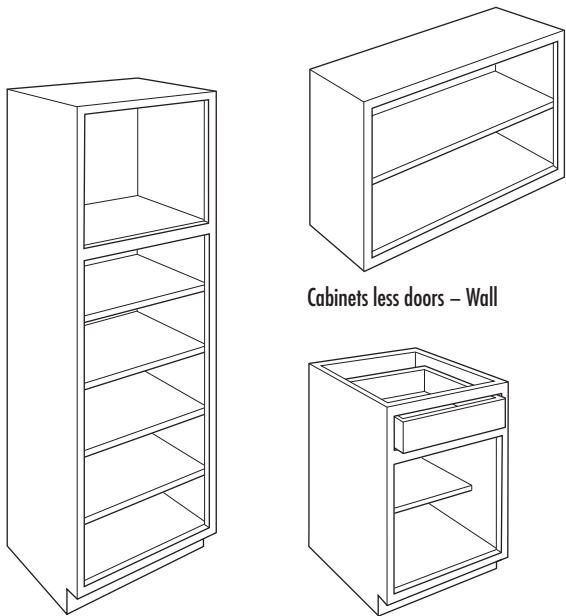

Cabinets less doors – Tall

Cabinets less doors – Wall

Cabinets less doors and drawer fronts – Base

### CABINET CASE ONLY (CCO)

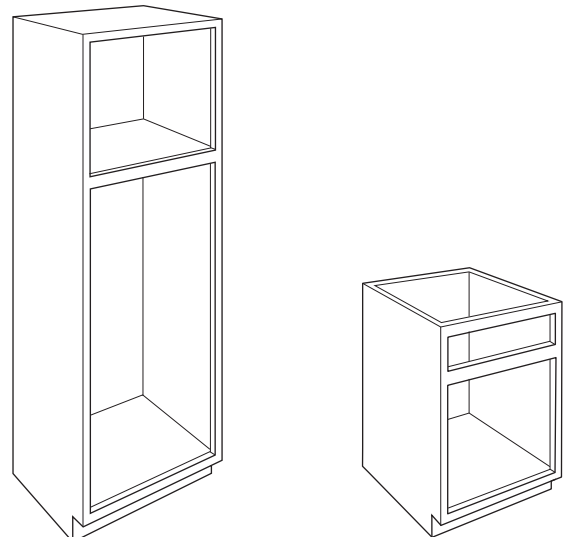

Cabinet case only – Tall

Cabinet case only – Base

### CABINET FALSE PANEL (CFP)

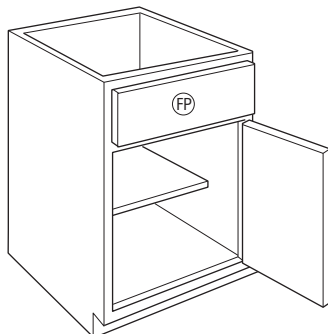

Base and Vanity cabinets

### CABINET WITH NO DOOR, WITH DRAWER (CND)

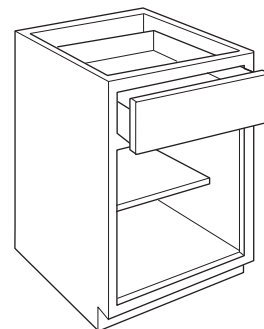

Base and Vanity cabinets

# BOX MODIFICATIONS (cont'd)

See page 37 for modification compatibility. Requests for non-published modifications may be treated as a Special Sales Order which will require feasibility, leadtime review and approval. Please check with your customer service representative before placing your order.

OPTION NAME	APPLICABLE CABINET GROUP	DESCRIPTION/LIMITATIONS
<b>Increased Depth (ID)</b>	Most wall and vanity cabinets	Increases the depth of wall and vanity cabinets in 1" increments to a maximum depth of 24". Increased depth wall cabinets should be either floor mounted or stacked to maintain stability. Any specified shelving is included and is always full depth. Wall peninsula cabinets may be increased in 1" increments to 18" maximum. Depth restrictions may apply where depths are available as a standard cabinet.
	Most base, tall, and vanity cabinets without drawers or roll trays	Increases the depth of base, tall, and vanity cabinets without drawers or roll trays in 1" increments to 27". When depth beyond 24" is desired on tall cabinets, the 24" deep cabinet must be modified. Any specified shelving is included and is always full depth. Depth restrictions may apply where depths are available as a standard cabinet.
	Oven Cabinets	Increases the depth of oven cabinets in 1" increments to a maximum depth of 27". When oven cabinets with drawers are increased, drawer depth will not change. Any specified shelving is included and is always full depth.
	End panels	Increases the depth of end panels in 1" increments to a maximum depth of 36". 31"-36" depths available on plywood panels only. AEL/AER panels are only available in 3" increments up to a maximum depth of 36".
<b>Reduced Depth (RD)</b>	Most base, tall, and vanity cabinets with drawers or roll trays	Reduces the depth in 1" increments to a minimum depth of 12". Any specified shelving is included and is always full depth. The dimension is specified as the distance from the front of the face frame to the back of the cabinet.
	Most base, tall, and vanity cabinets without drawers or roll trays	Reduces the depth in 1" increments to a minimum depth of 6". If reduced depth to 8" or less, toekick will not be included. Any specified shelving is included and is always full depth. The dimension is specified as the distance from the front of the face frame to the back of the cabinet.
	Most wall cabinets	Reduces the depth in 1" increments to a minimum depth of 6". Any specified shelving is included and is always full depth. The dimension is specified as the distance from the front of the face frame to the back of the cabinet. Wall top hinge cabinets can only be reduced to 9" depth minimum.
	End panels	Reduces the depth in 1" increments to a minimum depth of 6".
	Roll tray kits	Reduces the depth in 1" increments to fit a minimum cabinet depth of 12".

Cabinet Depth	Drawer Box and Roll Tray Exterior Depth		Clearance Behind Drawer Box or Roll Tray and Back Panel	
	Standard Drawer Guides	Heavy Duty Side-mount Guides (DDFD)	Standard Drawer Guides	Heavy Duty Side-mount Guides (DDFD)
24	21	21	2 3/4	2 3/4
23	21	18	1 3/4	4 3/4
22	18	18	3 3/4	3 3/4
21	18	18	2 3/4	2 3/4
20	18	N/A	1 3/4	N/A
19	15	N/A	3 3/4	N/A
18	15	N/A	2 3/4	N/A
17	15	N/A	1 3/4	N/A
16	12	N/A	3 3/4	N/A
15	12	N/A	2 3/4	N/A
14	12	N/A	1 3/4	N/A
13	9	N/A	3 3/4	N/A
12	9	N/A	2 3/4	N/A

## INCREASED DEPTH (ID)

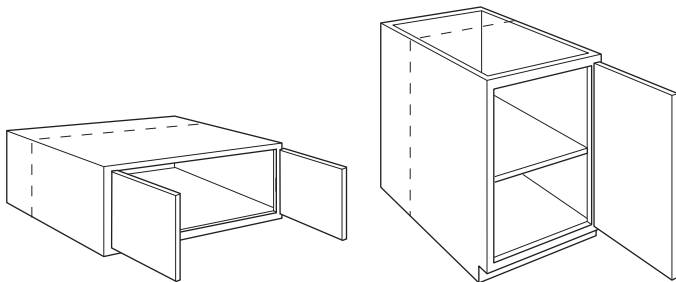

Wall cabinets

Base cabinets

## REDUCED DEPTH (RD)

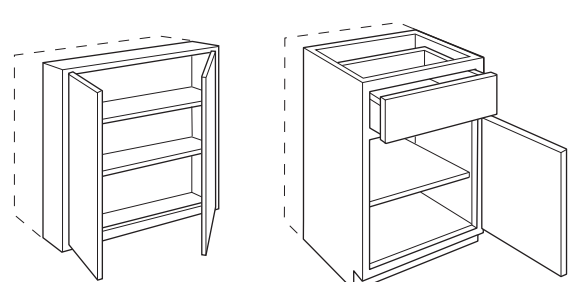

Wall cabinets

Base cabinets

## BOX MODIFICATIONS (cont'd)

See page 37 for modification compatibility. Requests for non-published modifications may be treated as a Special Sales Order which will require feasibility, leadtime review and approval. Please check with your customer service representative before placing your order.

OPTION NAME	APPLICABLE CABINET GROUP	DESCRIPTION/LIMITATIONS
<b>End Extended Back (EXBKL) (EXBKR)</b>	Most cabinets	<p>Extends cabinet end panel back in 1" increments, available up to 6" per side. Includes FPEB modification with 3/4" finished veneer end panels on both ends.</p> <p>EXBKL and EXBKR are compatible with each other and can be specified with either the same dimension per side or unique dimensions if desired. Compatible with Authentic Ends when End Extended Back is specified in 3" increments.</p>
<b>Prepare Cabinet for Finished Bottom (PFINBTMB)</b>	Most wall cabinets	<p>Prepares cabinet for installation of a separately purchased and field installed applied 1/4" end panel skin to create a flush finished bottom on a single cabinet or multiple cabinets that are bridged between taller adjacent cabinets.</p> <p>Features factory installed spacer blocks against the cabinet bottom, along the face frame, back, and end panels. Cabinet back and end panel heights are 1/4" less than the face frame, leaving clearance for the applied skin. Cabinet end panel bottom edge remains unfinished.</p> <p>Panel utilized for flush bottom must be purchased separately using 1/4" end panel skins (see WEPS__, TEPS__, or BEPS__ on pages 365-366) or 1/4" custom panels (see DAPNL1/4 on page 362), and requires cabinet installer to cut to size before installation.</p> <p>If used on the end of a run, moulding or a full height end panel skin must be purchased separately to cover exposed unfinished edge of applied skin for the flush finished bottom. Not compatible with FPEB, AUTHL/AUTHR, FFDL/FFDR, and EXBKL/EXBKR modifications.</p>

**END EXTENDED BACK LEFT (EXBKL)**

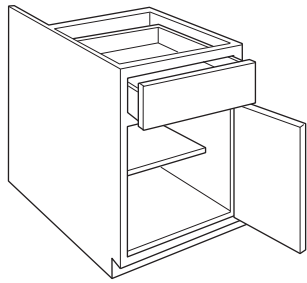

**END EXTENDED BACK RIGHT (EXBKR)**

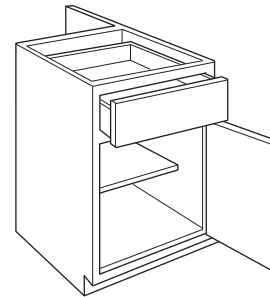

**PREPARE CABINET FOR FINISHED BOTTOM (PFINBTMB)**

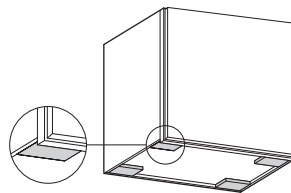

# FACE FRAME MODIFICATIONS

See page 37 for modification compatibility. Requests for non-published modifications may be treated as a Special Sales Order which will require feasibility, leadtime review and approval. Please check with your customer service representative before placing your order.

OPTION NAME	APPLICABLE CABINET GROUP	DESCRIPTION/LIMITATIONS
<b>Appliance Cut-out, Single (ACS)</b>	Most Oven Cabinets	<p>Creates a custom cut-out area for field-ready oven installation.</p> <p>Custom Width dimension available in 1/4" increments, with a minimum of 1/2" to a maximum of 6" less than the cabinet width. Frame side stiles will not be notched.</p> <p>Custom Height dimension available in 1/4" increments.</p> <ul style="list-style-type: none"> <li>• Cut-out area will be centered.</li> <li>• Available on oven cabinets specified with an (N) for Narrow Stile, with 1 1/2" wide frame side stiles. See cabinet specifications for available cut-out dimensions.</li> </ul>
<b>Extended Stile (EXL) (EXR)</b>	Most cabinets with a face frame	<p>Extends face frame width beyond its normal width by specified dimension to eliminate the need for field installed fillers, available in 1/2" increments from 1/2"-3". For example, a 1 1/2" wide face frame with EXL2 will have a width of 3 1/2" on the left side of the cabinet.</p> <p>Extended Left: EXL.5, EXL1, EXL1.5, EXL2, EXL2.5, EXL3                      Extended Right: EXR.5, EXR1, EXR1.5, EXR2, EXR2.5, EXR3</p> <p>EXL and EXR are compatible with each other and can be specified with either the same dimension per side or unique dimensions if desired. When ordered with Peninsula (P) modification, both face frames on specified side will be modified.</p>

## APPLIANCE CUT-OUT, SINGLE (ACS)

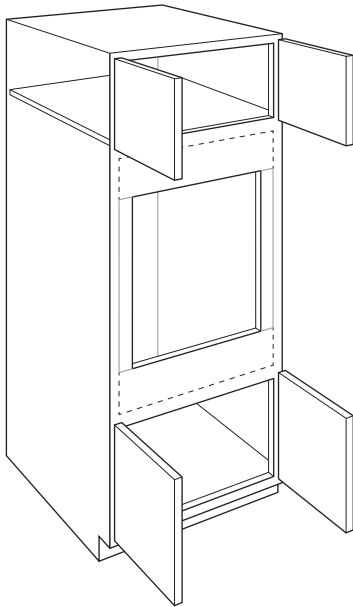

## EXTENDED STILE LEFT (EXL)

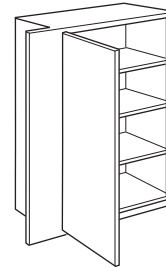

Cabinets with a face frame – Wall

## EXTENDED STILE RIGHT (EXR)

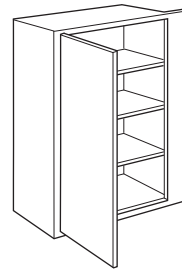

Cabinets with a face frame – Wall

## FACE FRAME MODIFICATIONS (cont'd)

See page 37 for modification compatibility. Requests for non-published modifications may be treated as a Special Sales Order which will require feasibility, leadtime review and approval. Please check with your customer service representative before placing your order.

OPTION NAME	APPLICABLE CABINET GROUP	DESCRIPTION/LIMITATIONS
<b>Inverted Frame (INVFRM)</b>	Most cabinets with a face frame cross rail  Tall Panels with Filler Attached and Authentic Ends	Inverts face frame openings. Drawer openings relocated to the bottom of a base cabinet must always be a working drawer. Opening sizes for doors do not change, standard drawer opening changes to 4 1/2" high.  On tall and stacked walls, when INVFRM is ordered in conjunction with CG (Cut-for-glass), top and bottom locations should be specified after the frame is inverted. Glass only available on doors for 41 1/2" high or less.  Doors on inverted frame cabinets may not align with adjacent cabinet doors.  On Tall Panels with Filler Attached and Authentic Ends, when INVFRM is selected, doors will be inverted (no face frame) to align with tall cabinets with the modification.
<b>Valance Top Rail (TVRAV) (TVRFV) (TVRVV)</b>	Base Open Cabinets, Bookcases, Wall Open Cabinets	Modifies the top rail with an arch, furniture, or straight valance.

### INVERTED FRAME (INVFRM)

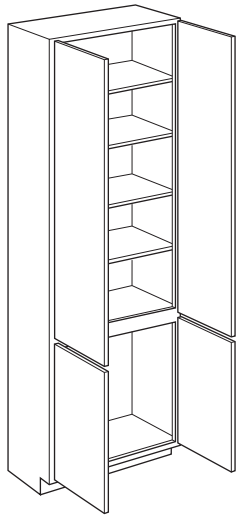

Tall cabinets

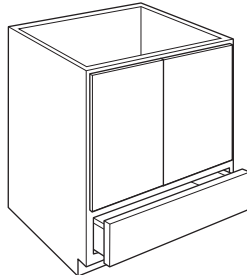

Base cabinets

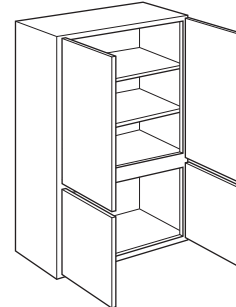

Wall cabinets

#### VALANCE TOP RAIL, ARCH (TVRAV)

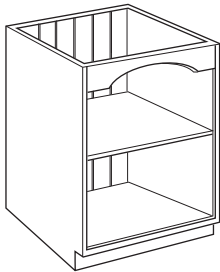

#### VALANCE TOP RAIL, FURNITURE (TVRFV)

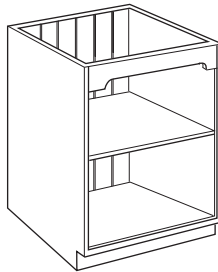

#### VALANCE TOP RAIL, STRAIGHT (TVRVV)

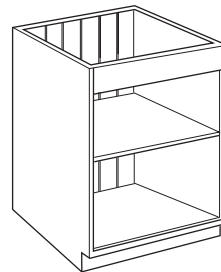

# INSTALLED INTERIOR MODIFICATIONS

See page 37 for modification compatibility. Requests for non-published modifications may be treated as a Special Sales Order which will require feasibility, leadtime review and approval. Please check with your customer service representative before placing your order.

OPTION NAME	APPLICABLE CABINET GROUP	DESCRIPTION/LIMITATIONS
<b>Secured Drawer featuring Master Lock Biometric Technology (DRWSEC) (DRWSECB) (DRWSECL) (DRWSECR)</b> 	Most base cabinets 18", 21", 24" wide with a top drawer	Modifies the standard drawer box with an installed self-locking mechanism featuring proven Master Lock advanced sensor biometric technology. When activated, drawer opens 2 3/16" to access fingerprint reader, which stores up to 100 unique fingerprints. Homeowner must reset memory after cabinet installation. Secured housing protrudes 2 3/4" into the depth of the drawer box interior.  Features one 9V battery compartment (battery not included). Self-locking when in closed position. Manual key lock on bottom of drawer for backup method of entry.  DRWSEC available on 24" deep base cabinets with widths of 18", 21", and 24".  DRWSECL, DRWSECR, and DRWSECB available on 24" deep base cabinets with widths of 42" and 48".  Not compatible with Reduced Depth (RD) modification or PowerGlide™ Compact Drawer Outlet (DRWPWR).  Installer must remove the drawer front to drill and countersink the back of the drawer front for field installation of knobs and pulls.
<b>CabMat™ (CMAT1) (CMAT2)</b>	Most sink base and vanity cabinets	Installs removable CabMat™, size is determined by face frame opening width and cabinet depth.  CMAT2 is only available on vanity cabinets designed for double bowl applications.  Not available with Reduced Depth modification. When ordered with Increased Depth modification, CabMat™ size does not change.  Vanity cabinets with face frame openings of 24" and 30" will utilize CabMat™ sized for 21" and 27" openings.
<b>Full Depth Shelf (FD)</b>	Base cabinets with standard half depth shelves	Replaces standard shelf with full depth shelf.

## SECURED DRAWER FEATURING MASTER LOCK BIOMETRIC TECHNOLOGY (DRWSEC/DRWSECB/DRWSECL/DRWSECR)

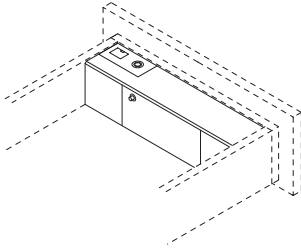

## FULL DEPTH SHELF (FD)

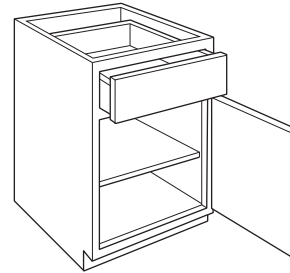

## CABMAT™ (CMAT1/CMAT2)

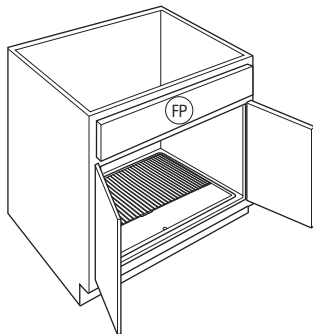

Base cabinets (CMAT1)

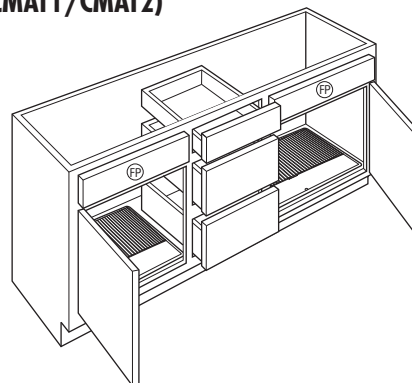

Vanity cabinets with double bowl (CMAT2)



## INSTALLED INTERIOR MODIFICATIONS (cont'd)

See page 37 for modification compatibility. Requests for non-published modifications may be treated as a Special Sales Order which will require feasibility, leadtime review and approval. Please check with your customer service representative before placing your order.

OPTION NAME	APPLICABLE CABINET GROUP	DESCRIPTION/LIMITATIONS
<b>Deep Roll Tray (DRT)</b>	Most cabinets with roll trays	Replaces standard roll trays with a 6 3/8" high deep roll tray. Replaces bottom roll tray only on base cabinets and bottom 2 roll trays on utility cabinets.
<b>EasyTrax™ (ET)</b>	Most cabinets with roll trays	Includes pre-installed upright wooden system that allows for easy height adjustment of roll trays.
<b>Installed Roll Tray (RT)</b>	Select base, tall, office, and vanity cabinets	<p>Installs specified number of roll trays (1-5 per side). Example, for two roll trays, specify 2RT.</p> <p>On cabinets with center stile, specify RTL for roll trays in left side and RTR for roll trays in right side. RTL and RTR should be selected for roll trays in both sides.</p> <p>When 1RT is specified on a base cabinet, the roll tray is installed in the lowest position and one half depth adjustable shelf is included. On utility cabinets for lower section, 1RT includes three shelves, 2RT includes two shelves, and 3RT includes 1 shelf. No shelves for lower section are included with 4RT or 5RT.</p>
<b>Light Installed Battery Strip (LTI.BS) (LTI.BSB) (LTI.BSL) (LTI.BSR)</b>	Select base, office, and vanity cabinets	<p>Installs a battery operated LED light inside the cabinet door opening(s).</p> <p>LTI.BS installs one LED light inside the cabinet door opening.</p> <p>LTI.BSB installs two LED lights inside both left and right cabinet door openings. On corner cabinets, installs one LED light for the top section and one LED light below fixed shelf for bottom section.</p> <p>LTI.BSL installs one LED light in the left door opening.</p> <p>LTI.BSR installs one LED light in the right door opening.</p> <p>Battery operated - (4) AAA batteries (not included). Motion activated. Low power usage (0.3W). Plastic aluminum finish. Dimensions: Length 11.93" (303mm), Width 0.67" (17mm), and Depth 0.55" (14mm).</p>

### DEEP ROLL TRAY (DRT)

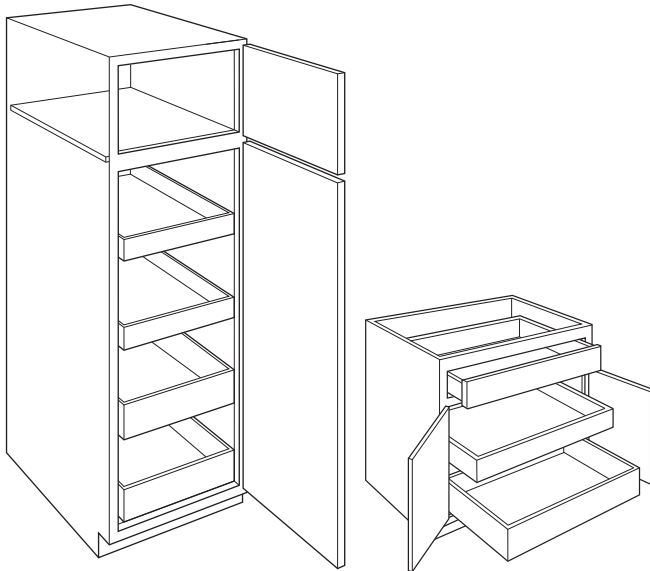

Tall cabinets

Base cabinets

### INSTALLED ROLL TRAY (RT)

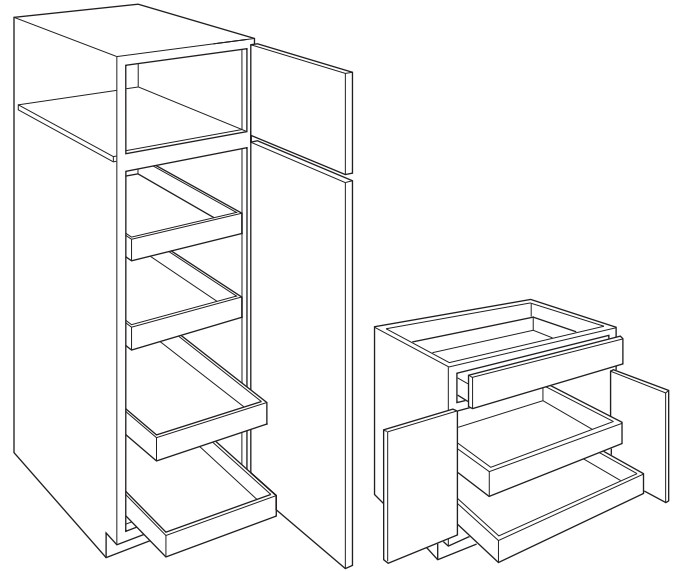

Tall cabinets

Base, Office, and Vanity cabinets

### LIGHT INSTALLED BATTERY STRIP (LTI.BS/LTI.BSB/LTI.BSL/LTI.BSR)

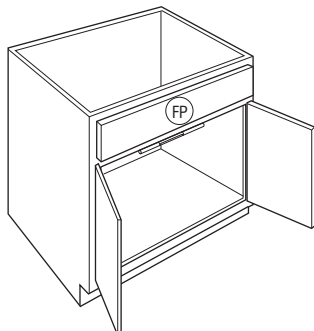

Base cabinet (LTI.BS)

### EASYTRAX™ (ET)

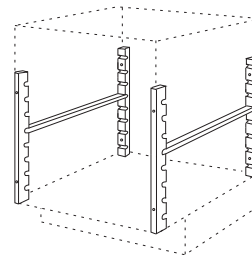

## INSTALLED INTERIOR MODIFICATIONS (cont'd)

See page 37 for modification compatibility. Requests for non-published modifications may be treated as a Special Sales Order which will require feasibility, leadtime review and approval. Please check with your customer service representative before placing your order.

OPTION NAME	APPLICABLE CABINET GROUP	DESCRIPTION/LIMITATIONS
<b>PowerGlide™ Compact Drawer Outlet</b> (DRWPWR) (DRWPWRB) (DRWPWRL) (DRWPWRR)	Most base cabinets with a top drawer	Installs PowerGlide™ Compact Drawer Outlet into the drawer box. Includes two 120V electrical plug-ins and two 2.1 amp rated USB charging ports with a total rated capacity of 15 amps. Cord has 3 ft. of length hanging freely from back mounting bracket. The cord is 14 gauge wire and features a standard 3-prong plug and is required to be plugged into an approved GFCI outlet for all applications. Outlet is ETL approved-compliant for electrical and other safety standards to U.S. and Canadian safety including UL standards. Outlet face plate measures 5.22" x 2.3" and will extend 3/4" into drawer box. Available on base cabinet widths of 18"-36". For use in cabinet depths of 15", 18", 21", and 24". Only compatible with RD in 3" increments. Also available as a field installed accessory, see DRWPWR1 on page 422.
<b>Push to Open Wastebasket (PTOWB)</b>	Base cabinets with door mounted wastebasket pull-outs	Changes the guide mechanism on wastebasket pull-outs to a mechanical push to open guide with Smart Stop. Available on 24" deep cabinets only. Does not change other drawer guides on the cabinet.
<b>Tilt-out Tray, Stainless Steel (TOTSS)</b>  <b>Stainless Steel Slim (TOTSSS)</b>	Cabinets with false panels	Installs one stainless steel tilt-out tray inside of each false panel. Available as standard depth (2" deep) or a slim version (1 11/16" deep) to be used in narrow spaces. Standard trays protrude 1 1/16" into cabinet. Slim trays protrude 3/4" into cabinet.

### POWERGLIDE™ COMPACT DRAWER OUTLET (DRWPWR/DRWPWRB/DRWPWRL/DRWPWRR)

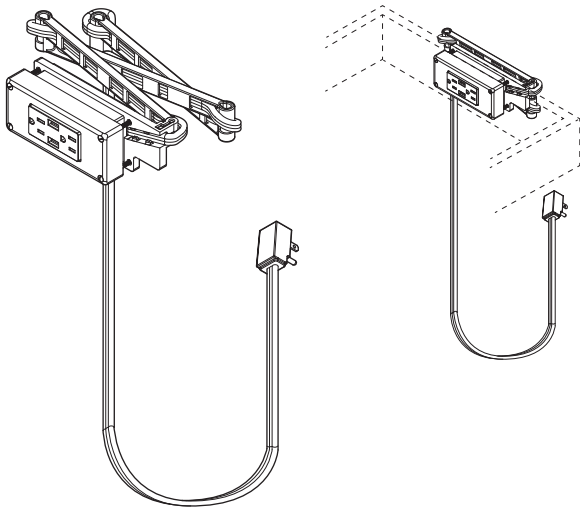

### TILT-OUT TRAY, STAINLESS STEEL (TOTSS) & STAINLESS STEEL SLIM (TOTSSS)

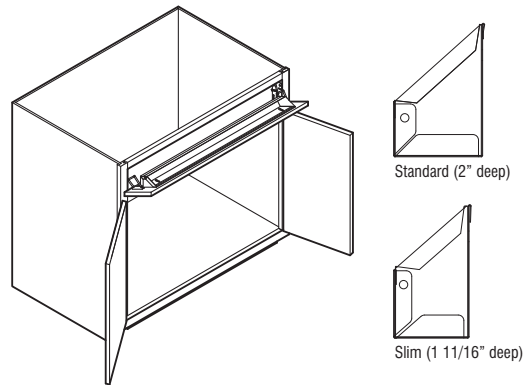

### PUSH TO OPEN WASTEBASKET (PTOWB)

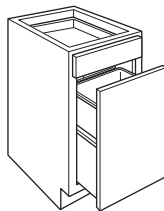

## INSTALLED INTERIOR MODIFICATIONS (cont'd)

See page 37 for modification compatibility. Requests for non-published modifications may be treated as a Special Sales Order which will require feasibility, leadtime review and approval. Please check with your customer service representative before placing your order.

OPTION NAME	APPLICABLE CABINET GROUP	DESCRIPTION/LIMITATIONS																		
<b>Tray Dividers (TD)</b>	Most wall, full height base, and tall cabinets	<p>Installs removable Tray Dividers. Plywood dividers match the interior of the cabinet. Rails for dividers are Natural Maple regardless of the color of the interior of the cabinet.</p> <p>Number of dividers is predetermined based on cabinet width. See chart below.</p> <p>Available only in the top of Stacked Walls and Tall Cabinets.</p> <p>Available with Reduced Depth modification (12" minimum) and Increased Depth modification (27" maximum). When cabinet is increased to 27", tray dividers will be 24" deep set back 3" into the cabinet.</p> <p>Base Full Height cabinets will have a top. Not available with Peninsula modification.</p> <p>Available on cabinets with frame height openings of 15"-27" with full top and bottom panels.</p> <table border="1" style="margin: 10px auto; border-collapse: collapse;"> <thead> <tr> <th style="text-align: center;">Cabinet Width</th> <th style="text-align: center;"># of Dividers</th> <th style="text-align: center;">Mod Name</th> </tr> </thead> <tbody> <tr> <td style="text-align: center;">9"-12"</td> <td style="text-align: center;">1</td> <td style="text-align: center;">1TD</td> </tr> <tr> <td style="text-align: center;">15"-18"</td> <td style="text-align: center;">2</td> <td style="text-align: center;">2TD</td> </tr> <tr> <td style="text-align: center;">21"-24"</td> <td style="text-align: center;">3</td> <td style="text-align: center;">3TD</td> </tr> <tr> <td style="text-align: center;">27"-30"</td> <td style="text-align: center;">4</td> <td style="text-align: center;">4TD</td> </tr> <tr> <td style="text-align: center;">33"-37"</td> <td style="text-align: center;">5</td> <td style="text-align: center;">5TD</td> </tr> </tbody> </table>	Cabinet Width	# of Dividers	Mod Name	9"-12"	1	1TD	15"-18"	2	2TD	21"-24"	3	3TD	27"-30"	4	4TD	33"-37"	5	5TD
Cabinet Width	# of Dividers	Mod Name																		
9"-12"	1	1TD																		
15"-18"	2	2TD																		
21"-24"	3	3TD																		
27"-30"	4	4TD																		
33"-37"	5	5TD																		

### TRAY DIVIDERS (TD)

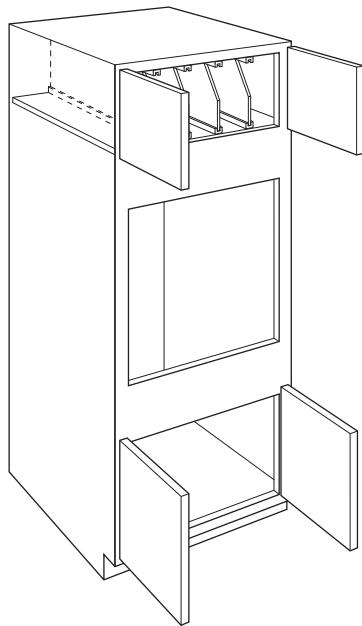

Tall cabinets

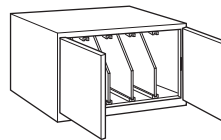

Wall cabinets

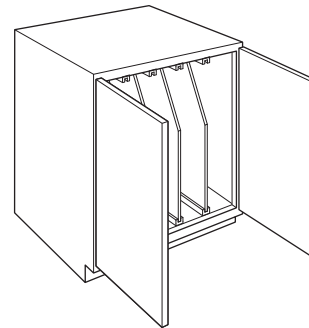

Base cabinets

# TOEKICK MODIFICATIONS

See page 37 for modification compatibility. Requests for non-published modifications may be treated as a Special Sales Order which will require feasibility, leadtime review and approval. Please check with your customer service representative before placing your order.

OPTION NAME	APPLICABLE CABINET GROUP	DESCRIPTION/LIMITATIONS
<b>Add Toekick (ADDTK)</b>	Most wall cabinets	<p>Creates a 4 1/2" toekick on the front of cabinet. Cabinet top changes to use I-Beam construction when ADDTK is selected. ADDTK with reduced depth is available on cabinets 9" deep or larger.</p> <p>Peninsula cabinets are available with ADDTK 15" deep and larger. Depths of 14" and less will not have ADDTK available.</p> <p>Furniture drawers will be available with ADDTK option down to a reduced depth of 12".</p> <p>All cabinets will feature square doors to match cabinets on order. If arch door style is ordered, 20/20 layout will show arch doors, however, square doors will be sent.</p> <p>Available with compatible toekick modifications. See the Modification/Upgrade Compatibility Chart on page 37 for details.</p>
<b>Flush Toekick (FTK) (FTK.FNT.P) (FTK.P)</b>	Most base, tall, and vanity cabinets, and wall cabinets with ADDTK	<p>Extends the face frame to the floor eliminating the toe space. Not available when either RECTKL or RECTKR modifications are used. Not available on 93" or 96" tall cabinets due to separate pedestal base toekick.</p> <p>When FTK is ordered with the Peninsula modification, only the working drawer side will receive a flush toekick.</p> <p>When FTK.FNT.P is ordered with the Peninsula modification, both sides will receive a flush toekick.</p> <p>When FTK.P is ordered with the Peninsula modification, only the peninsula side will receive a flush toekick.</p>

## ADD TOEKICK (ADDTK)

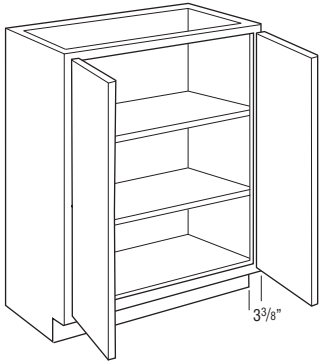

Wall cabinets

## FLUSH TOEKICK (FTK)

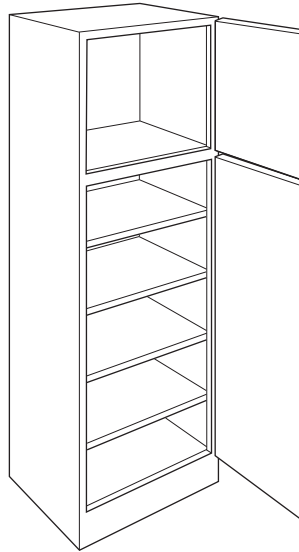

Tall cabinets

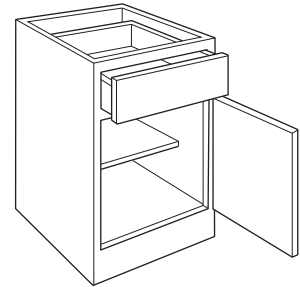

Base cabinets

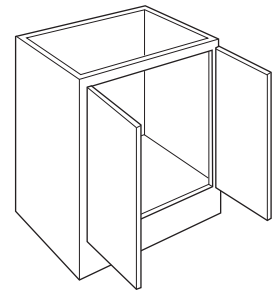

Vanity cabinets

## FLUSH TOEKICK FRONT & PENINSULA (FTK.FNT.P)

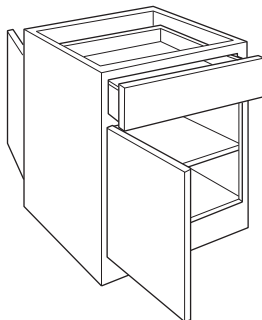

Base cabinets

## FLUSH TOEKICK PENINSULA (FTK.P)

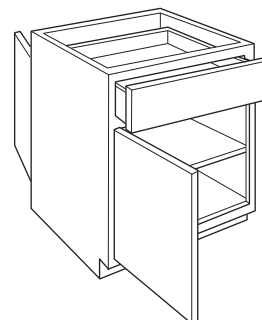

Base cabinets

## TOEKICK MODIFICATIONS (cont'd)

See page 37 for modification compatibility. Requests for non-published modifications may be treated as a Special Sales Order which will require feasibility, leadtime review and approval. Please check with your customer service representative before placing your order.

OPTION NAME	APPLICABLE CABINET GROUP	DESCRIPTION/LIMITATIONS
<b>Flush Toekick Arch (FTKAV) (FTKAV.P) (FTKAV.FNT.P)</b>	Most base, tall, and vanity cabinets, and wall cabinets with ADDTK	Creates an arch flush toe space. Valance replaces standard toekick creating a full open area beneath cabinet floor. When FTKAV.FNT.P is ordered with the Peninsula modification, both sides will receive an arch flush toekick. When FTKAV.P is ordered with the Peninsula modification, only the peninsula side will receive an arch flush toekick. Not available on 93" or 96" tall cabinets due to separate pedestal base toekick.
<b>Flush Toekick Furniture (FTKFV) (FTKFV.P) (FTKFV.FNT.P)</b>	Most base, tall, and vanity cabinets, and wall cabinets with ADDTK	Creates a furniture flush toe space. Valance replaces standard toekick creating a full open area beneath cabinet floor. When FTKFV.FNT.P is ordered with the Peninsula modification, both sides will receive a furniture flush toekick. When FTKFV.P is ordered with the Peninsula modification, only the peninsula side will receive a furniture flush toekick. Not available on 93" or 96" tall cabinets due to separate pedestal base toekick.

### FLUSH TOEKICK ARCH (FTKAV)

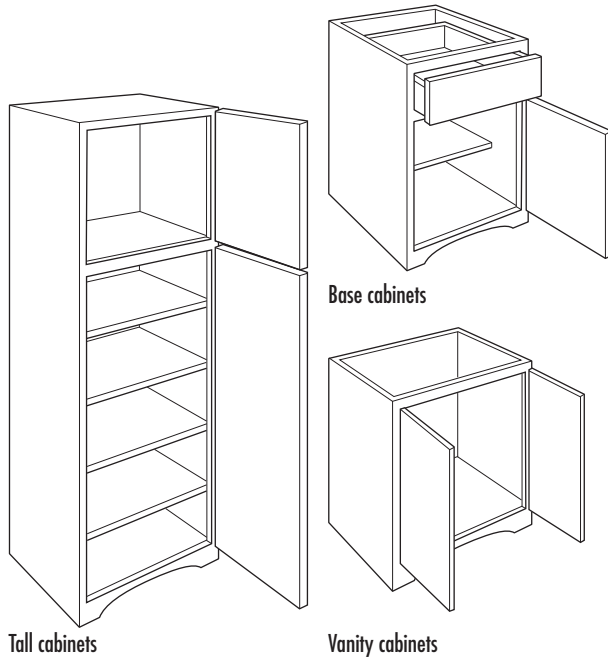

### FLUSH TOEKICK FURNITURE (FTKFV)

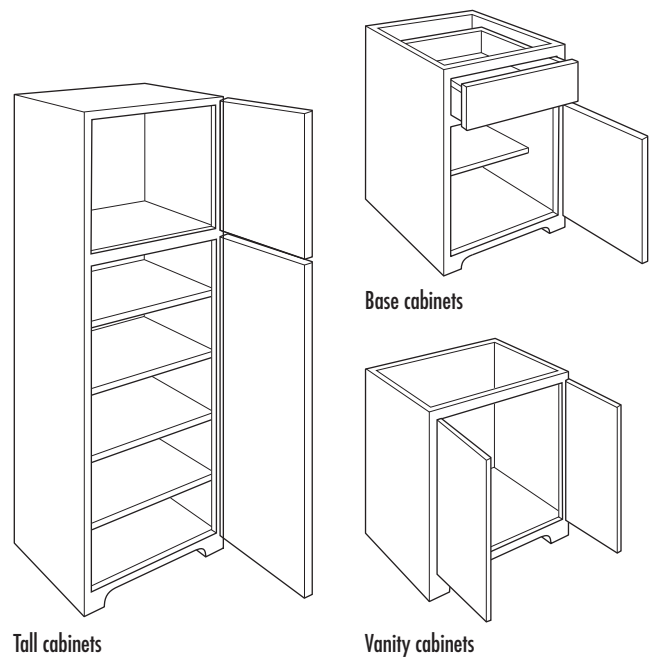

# TOEKICK MODIFICATIONS (cont'd)

See page 37 for modification compatibility. Requests for non-published modifications may be treated as a Special Sales Order which will require feasibility, leadtime review and approval. Please check with your customer service representative before placing your order.

OPTION NAME	APPLICABLE CABINET GROUP	DESCRIPTION/LIMITATIONS
<b>Loose Toekick (TKP)</b>	Most tall cabinets	Available on 84", 87", and 90" tall cabinets. Removes and ships the toekick separately. Not compatible with other toekick modifications. Pedestal is designed to create a Recessed Left or Right Toekick (RECTKL or RECTKR) application during field installation, or can be centered. Pedestal must be covered with toeboard material.
<b>Recessed Island Toekick (RECTKALL)</b>	Most base and vanity cabinets, and wall cabinets with ADDTK	Creates a 3 3/8" recessed toekick on the right, left, and back of cabinet. The entire toekick area will have non-matching material and requires any exposed toekick area to be covered.
<b>Recessed Toekick on Back or Side (RECTKBK) (RECTKL) (RECTKR)</b>	Most base and vanity cabinets, and wall cabinets with ADDTK	Creates a 3 3/8" recessed toekick on the back (RECTKBK), left (RECTKL), or right (RECTKR). When either the RECTKR or RECTKL are used, FTK is NOT available. The entire toekick will have non-matching material and requires any exposed toekick area to be covered. On RECTKL and RECTKR, the back will have a 1/2" recessed offset and non-specified side will have a 1/2" recessed offset to allow for application of toeboard material.  93" and 96" tall cabinets have RECTKL or RECTKR standard on loose pedestal. For recess toekick applications of both left and right, order RECTKL.R. On 9" wide cabinets, only one side can be recessed. RECTKBK only available on cabinets at least 15" deep.

## LOOSE TOEKICK (TKP)

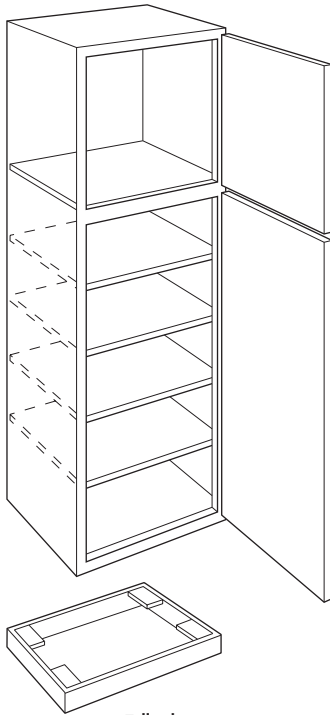

Tall cabinets

Pedestal is reduced in width for RECTKL or RECTKR during field installation.

## RECESSED ISLAND TOEKICK (RECTKALL)

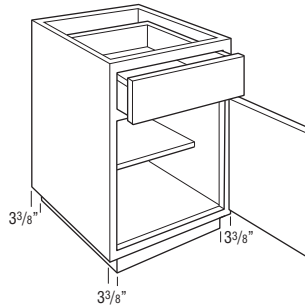

Base cabinets

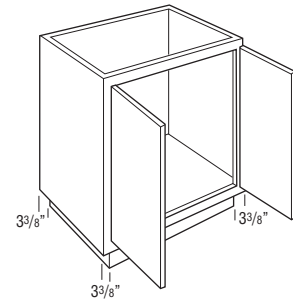

Vanity cabinets

## RECESSED TOEKICK - BACK (RECTKBK)

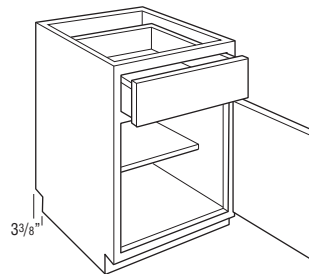

Base cabinets

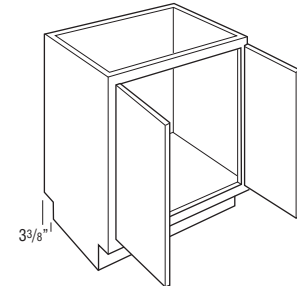

Vanity cabinets

## RECESSED TOEKICK - LEFT (RECTKL)

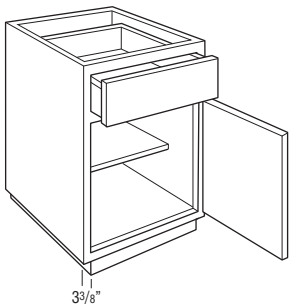

Base cabinets

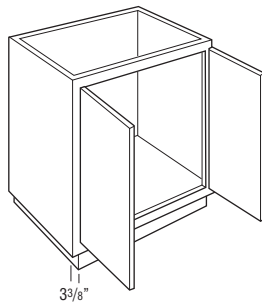

Vanity cabinets

## RECESSED TOEKICK - RIGHT (RECTKR)

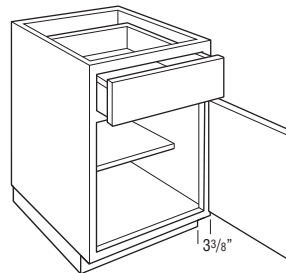

Base cabinets

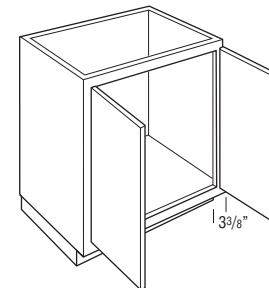

Vanity cabinets

## TOEKICK MODIFICATIONS (cont'd)

See page 37 for modification compatibility. Requests for non-published modifications may be treated as a Special Sales Order which will require feasibility, leadtime review and approval. Please check with your customer service representative before placing your order.

OPTION NAME	APPLICABLE CABINET GROUP	DESCRIPTION/LIMITATIONS
<b>Toekick Drawer (DRWTK)</b>	Most cabinets with a standard toekick, and wall cabinets with ADDTK	Replaces standard toekick with a toekick drawer. Available on most 21"-24" deep cabinets in 18", 21", 24", 27", 30", 33", and 36" widths that have standard toekick construction. Front of toekick drawer is unfinished, allow enough toeboard to cover. 1" clearance below toekick drawer. Exterior dimensions of drawer are 3 3/8" tall and 15" or 18" deep. Toekick drawer uses a push to open full extension guide, does not have soft-close feature.
<b>Void Toekick (VTK)</b>	Most base, tall, and vanity cabinets	Removes the toekick. Only available when the cabinet has a standard toekick (not available when flush toekick is standard or when cabinet has a separate pedestal base). When ordered on 84", 87", or 90" tall cabinets, pedestal will not be included. When VTK is specified on cabinets to be used with a countertop, cabinets must also be supported from the floor, not just attached to the wall. Failure to properly install cabinets in this situation will void the warranty.

### TOEKICK DRAWER (DRWTK)

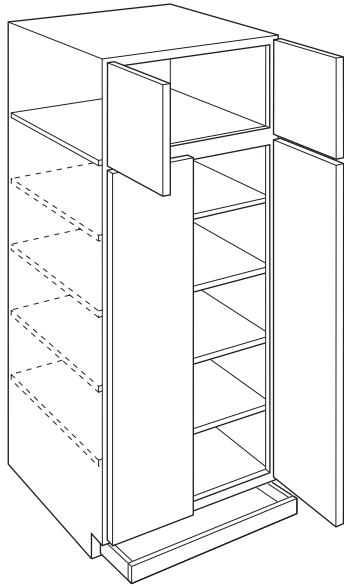

Tall cabinets

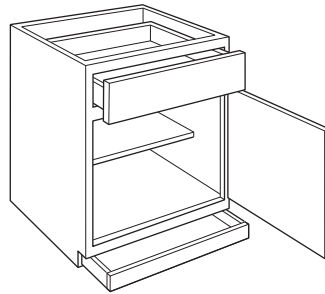

Base cabinets

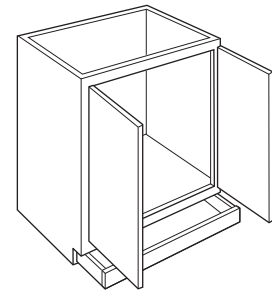

Vanity cabinets

### VOID TOEKICK (VTK)

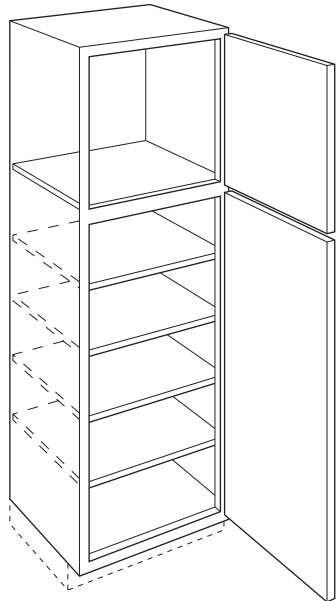

Tall cabinets

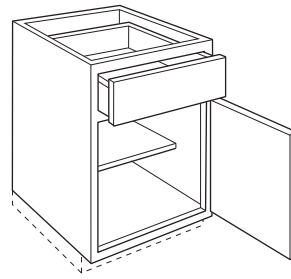

Base cabinets

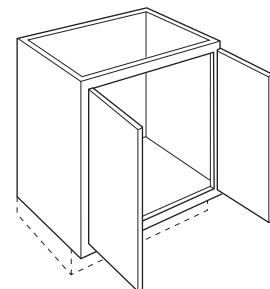

Vanity cabinets



# CONFIGURATION MODIFICATIONS

See page 37 for modification compatibility. Requests for non-published modifications may be treated as a Special Sales Order which will require feasibility, leadtime review and approval. Please check with your customer service representative before placing your order.

OPTION NAME	APPLICABLE CABINET GROUP	DESCRIPTION/LIMITATIONS
<b>Cabinet Front Only (CFNTO)</b>	Most cabinets with a face frame	Creates a door and/or drawer front assembled with a frame. Doors are attached with the specified hinges and drawer fronts are cleated.
<b>Cabinet Frame Only (CFRMO)</b>	Most cabinets with a face frame	Creates a cabinet frame only. No box, doors, or drawer fronts are included.
<b>Peninsula (P)</b>	Most wall and base cabinets	Creates a peninsula cabinet that is 1/4" deeper than the standard cabinet depth. If ID or RD is specified, cabinet will be 1/4" deeper than specified cabinet depth.  Any cabinet with a toekick must be at least 15" deep (either standard with a toekick or when ADDTK is specified).  Single door cabinets are hinged on the same cabinet end, for example a W1230L will feature a Left hinge on the front side and a Right hinge on the peninsula side.  Not available on tall cabinets (oven, utility, and pantry) or multi-drawer base cabinets.  Cabinets with drawers can only be reduced in 3" increments.

## CABINET FRONT ONLY (CFNTO)

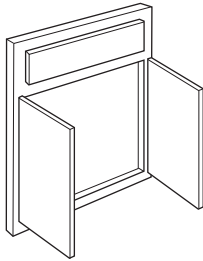

Cabinet front only – Wall, Base, and Tall

## CABINET FRAME ONLY (CFRMO)

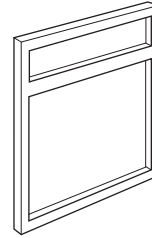

Cabinet frame only – Wall, Base, and Tall

## PENINSULA (P)

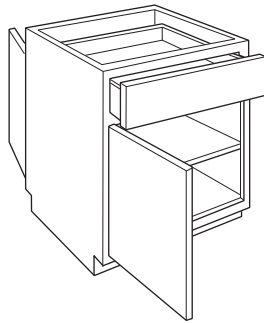

Base cabinets

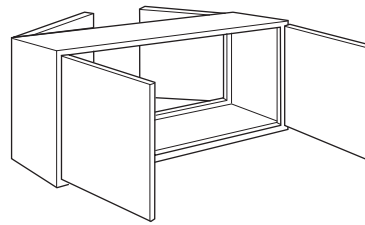

Wall cabinets

# ALUMINUM FRAME DOOR OPTIONS

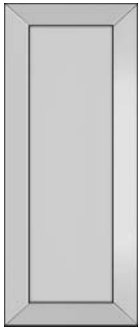

**ALF**  
Aluminum Frame Door  
in Aluminum finish  
with Frost glass

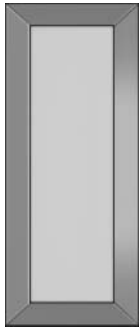

**ALFBS**  
Aluminum Frame Door  
with a Brushed Stainless  
Steel look with Frost glass

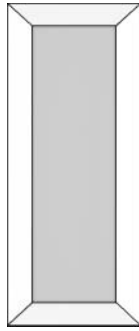

**ALFW**  
Aluminum Frame Door  
with a White powder coat  
finish with Frost glass

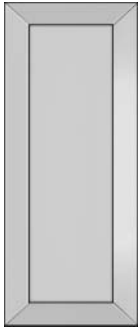

**ALFM**  
Aluminum Frame Door  
in Aluminum finish with  
matching center panel

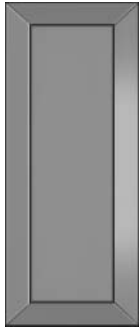

**ALFBSM**  
Aluminum Frame Door  
with a Brushed Stainless  
Steel look with matching  
center panel

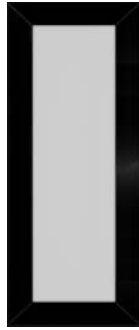

**ALFOR**  
Aluminum Frame Door  
with an Oil Rubbed  
Bronze powder coat finish  
with Frost glass

## ALF AVAILABILITY

Cabinet Width	Cabinet Height					
	12"	15"	18"	21"	30"	36"
W12	–	–	–	–	✓	✓
W15	✓	✓	–	–	✓	✓
W18	✓	✓	–	–	✓	✓
W21	–	–	–	–	✓	✓
WTH30 & WTH30..24	✓	✓	✓	✓	–	–
WVL30 & WVL30..24	–	–	✓	✓	–	–
WTH36 & WTH36..24	✓	✓	✓	✓	–	–
WVL36 & WVL36..24	–	–	✓	✓	–	–

- All aluminum doors will be full overlay with miter construction.
- Cabinet face frame and end panels will be matched to the finish specified.
- Aluminum and Brushed Stainless doors have an anodized finish.
- White and Oil Rubbed Bronze doors have a powder coated finish.
- Frost glass and matching panel are installed in door. Removal of glass or matching panel will void warranty.
- Door rails are 2 1/4" wide.
- All Aluminum Frame door options are represented by ALF in Door Options availability grids.
- ALFM and ALFBSM frames and center panels are created with different manufacturing processes, which results in a slight difference in the appearance of each surface. The frame is an anodized aluminum extrusion, and the center panel is a double sided metal sheet applied to a hard-bore core.
- Cabinet will have standard interior or can be ordered with MIP option. When a decorative door option is chosen in 20/20, Matching Interior Plywood (MIP) is a preselected option. If MIP is not desired, it can be deselected by choosing NOTMIP.

## CUT-FOR-GLASS DOORS (CG)

Arch and Square - Glass not included

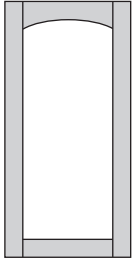

Cut-for-glass  
Arch

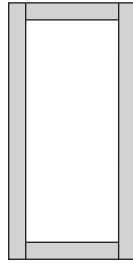

Cut-for-glass  
Square

58

DOOR MODIFICATION/SPECIALTY DOORS

- Not available in Catalina, Graniti, Tranter, Trystan, Wixom, and Worthen.
- If desired for use with Trystan, using a shaker style such as Breman, Montgomery, or Sumner is recommended.
- If ordered in an MDF door style, door will be Maple. On Stacked Wall (STW\_\_ ) and Utility cabinets (U\_\_ ), all cabinet doors will be Maple when ordered with a Cut-for-glass Door.
- Not available on bifold doors.
- Specify Arch/Square, Door Style, and Finish when ordering Cut-for-glass Doors.
- Custom door sizes available. See pages 360-363.
- Glass clips included with door.
- For cabinet availability, please see modification grids.
- CG.TOP and CG.BTM are specified on cabinets with upper and lower doors to designate which doors should be Cut-for-glass. See Door Options grid for SKU availability.
- When a decorative door option is chosen in 20/20, Matching Interior Plywood (MIP) is a preselected option. If MIP is not desired, it can be deselected by choosing NOTMIP.

# MULLION DOORS (MD)

Arch and Square - Tempered glass included

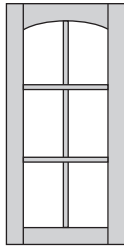

Mullion Arch

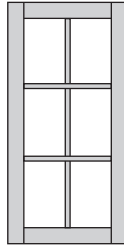

Mullion Square

- Available in all door styles except Davis, Graniti, Tranter, Trystan, Wells, Wixom, and Worthen.
- Custom Door Sizes not available.
- For Mullion Door availability, please see modification grids in wall section.
- If ordered in an MDF door style, door will be Maple.
- Includes Mullion Door and fully tempered clear glass for safety.
- Textured glass may be ordered to replace clear glass, except Bevel.
- On acknowledgment, textured glass will be listed with MDI modification.
- MD.TOP and MD.BTM are specified on cabinets with upper and lower doors to designate which doors should be Mullion Doors. See Door Options grid for SKU availability.
- Shelves will not align with mullions.
- Selena mullion doors are not available with Modified Full Overlay (MFO).
- When a decorative door option is chosen in 20/20, Matching Interior Plywood (MIP) is a preselected option. If MIP is not desired, it can be deselected by choosing NOTMIP.

## MULLION ARCH/SQUARE LITES GRID

Cabinet Width	Cabinet Height						
	18"	24"	30"	33"	36"	39"	42"
W15	G		D	D	D	A	A
W18	G		D	D	D	A	A
W21			E	E	E	B	B
W24			E	E	E	B	B
W24 (butt)			D	D	D	A	A
W27 (butt)			D	D	D	A	A
W30 (butt)	G	G	D	D	D	A	A
W33 (butt)			D	D	D	A	A
W36 (butt)	G	G	D	D	D	A	A
W42			E	E	E	B	B
W45			E	E	E	B	B
W48 (butt)			D	D	D	A	A
WC33			D	D	D	A	A
WC36			D	D	D	A	A
WC39			D	D	D	A	A
WC42			D	D	D	A	A
WC45			D	D	D	A	A
WC48			D	D	D	A	A
DW30/DW30T			D				
DW33/DW33T				D			
DW36/DW36T					D		
DW39/DW39T						A	
DW42/DW42T							A

## Mullion Door Configurations

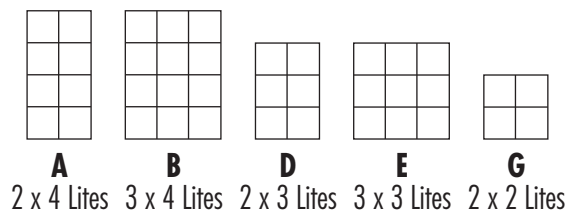

# SHAKER MULLION DOORS (SHMD)

Tempered glass included

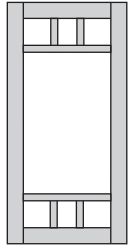

60

DOOR MODIFICATION/SPECIALTY DOORS

- Available in Breman, Liberty, Montgomery, Shiloh, and Sumner.
- Custom Door Sizes not available.
- Shelves will not align with mullions.
- For Mullion Door availability, please see modification grids in wall section.
- If ordered in an MDF door style, door will be Maple.
- Includes Mullion Door and fully tempered clear glass for safety.
- Textured glass may be ordered to replace clear glass, except Bevel.
- On acknowledgment, textured glass will be listed with SHMDI modification.
- When a decorative door option is chosen in 20/20, Matching Interior Plywood (MIP) is a preselected option. If MIP is not desired, it can be deselected by choosing NOTMIP.

## MULLION SHAKER LITES GRID

Cabinet Width	Cabinet Height						
	18"	24"	30"	33"	36"	39"	42"
W15†	H		H	H	H	H	H
W18	H		H	H	H	H	H
W21			H	H	H	H	H
W24			H	H	H	H	H
W24 (butt)			J	J	J	J	J
W27 (butt)			J	J	J	J	J
W30 (butt)†	H	H	H	H	H	H	H
W33 (butt)			H	H	H	H	H
W36 (butt)	H	H	H	H	H	H	H
W42			H	H	H	H	H
W45			H	H	H	H	H
W48 (butt)			J	J	J	J	J
WC33			H	H	H	H	H
WC36			H	H	H	H	H
WC39			J	H	H	H	H
WC42			J	H	H	H	H
WC45			J	H	H	H	H
WC48			H	H	H	H	H
DW30/DW30T			H				
DW33/DW33T				H			
DW36/DW36T					H		
DW39/DW39T						H	
DW42/DW42T							H

†Breman and Sumner will have "J Configuration" for 15" and 30" wide cabinets and all DW cabinets.

## Shaker Mullion Door Configurations

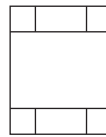

**H**  
3 x 3 Lites



**J**  
2 x 3 Lites

# PRAIRIE MULLION DOORS (PRMD)

Tempered glass included

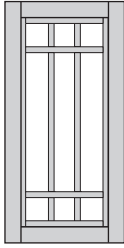

- Available in Breman, Liberty, Montgomery, Shiloh, and Sumner.
- Custom Door Sizes not available.
- Shelves will not align with mullions.
- For Mullion Door availability, please see modification grids in wall section.
- If ordered in an MDF door style, door will be Maple.
- Includes Mullion Door and fully tempered clear glass for safety.
- Textured glass may be ordered to replace clear glass, except Bevel.
- On acknowledgment, textured glass will be listed with PRMDI modification.
- When a decorative door option is chosen in 20/20, Matching Interior Plywood (MIP) is a preselected option. If MIP is not desired, it can be deselected by choosing NOTMIP.

## MULLION PRAIRIE LITES GRID

Cabinet Width	Cabinet Height						
	18"	24"	30"	33"	36"	39"	42"
W15†	K		K	K	K	K	K
W18	K		K	K	K	K	K
W21			K	K	K	K	K
W24			K	K	K	K	K
W24 (butt)			L	L	L	L	L
W27 (butt)			L	L	L	L	L
W30 (butt)†	K	K	K	K	K	K	K
W33 (butt)			K	K	K	K	K
W36 (butt)	K	K	K	K	K	K	K
W42			K	K	K	K	K
W45			K	K	K	K	K
W48 (butt)			L	L	L	L	L
WC33			K	K	K	K	K
WC36			K	K	K	K	K
WC39			L	K	K	K	K
WC42			L	K	K	K	K
WC45			L	K	K	K	K
WC48			K	K	K	K	K
DW30/DW30T			K				
DW33/DW33T				K			
DW36/DW36T					K		
DW39/DW39T						K	
DW42/DW42T							K

†Breman and Sumner will have "L Configuration" for 15" and 30" wide cabinets and all DW cabinets.

## Prairie Mullion Door Configurations

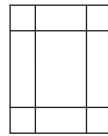

**K**  
3 x 3 Lites

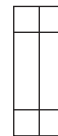

**L**  
2 x 3 Lites

# ART GLASS PANELS

62



Anson



Avondale

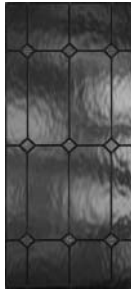

Cambridge



Charlotte

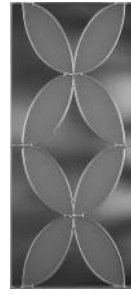

Ellington



Lanai

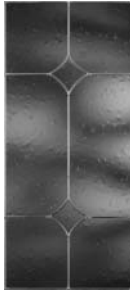

Lonsdale

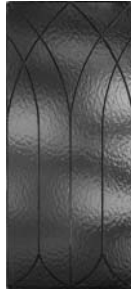

Lyndhurst



Pavillion

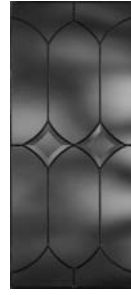

Portico



Quincy



Waterbury



Wickford

- Cut-for-glass door must be ordered separately. See page 58 for door style availability.
- For glass shelf kits, see pages 420-421.
- Door frame may reduce amount of glass shown.
- No changes or cancellations will be accepted after 24 hours from acknowledgment of order.
- Art glass will be packaged separately from applicable cabinet(s) and shipped with cabinet order for field installation.

GLASS INSERTS



# ART GLASS PANELS

## Anson

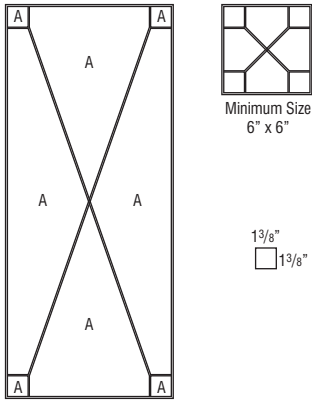

Glass Type:  
A) Clear Seedy 100SDY

Metal Type:

$\frac{3}{16}$ " H-Ch Zinc Proglaze2 (all)  
Black Patina Finish

- Suggested to use with Square doors.

## Cambridge

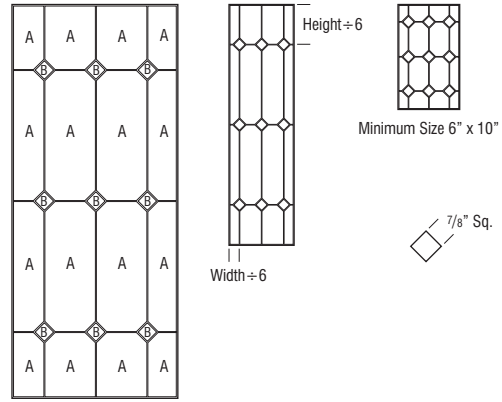

Glass Types:  
A) Clear Waterglass 100W  
B) Clear Sparkolite

Metal Type:  
 $\frac{3}{16}$ " H-Ch Zinc Proglaze2 (all)  
Black Patina Finish

## Avondale

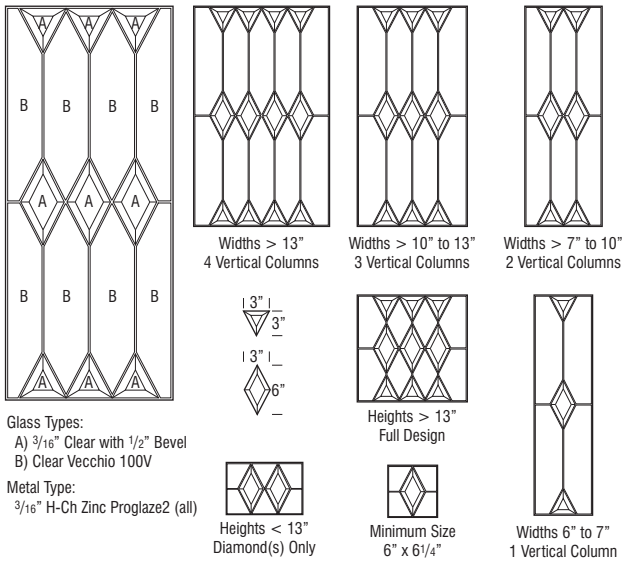

Glass Types:  
A)  $\frac{3}{16}$ " Clear with  $\frac{1}{2}$ " Bevel  
B) Clear Vecchio 100V

Metal Type:  
 $\frac{3}{16}$ " H-Ch Zinc Proglaze2 (all)

- Suggested to use with Square doors.

## Charlotte

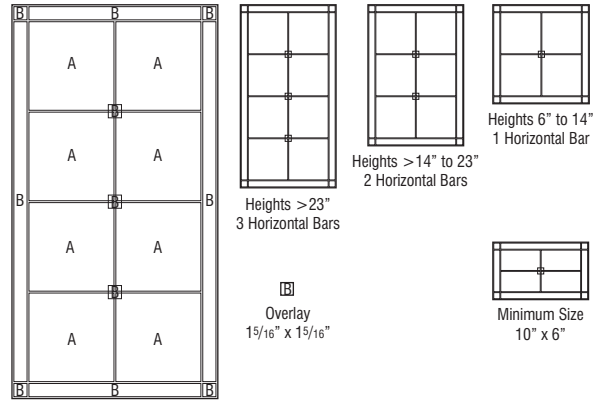

Glass Types:  
A)  $\frac{1}{8}$ " Clear  
B) Frost Etch 100

Metal Types:  
 $\frac{3}{16}$ " H-Ch Zinc Proglaze2 (all)  
 $\frac{1}{8}$ " U-Ch Zinc (overlays)

- Suggested to use with Square doors.

# ART GLASS PANELS

## Ellington

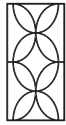
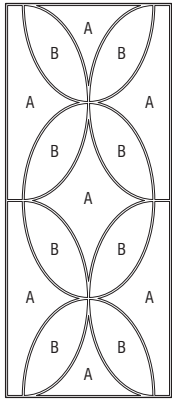

Heights > 12"  
Full Design

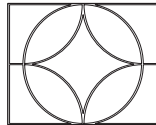

Heights 6" to 12"  
1 Center Diamond



Minimum Size  
6" x 6"  
1 Center Diamond

Glass Types:

- A) 1/8" Clear
- B) Frost Etch 100

Metal Type:

3/16" H-Ch Zinc Proglaze2 (all)

- Suggested to use with Square doors.

## Lonsdale

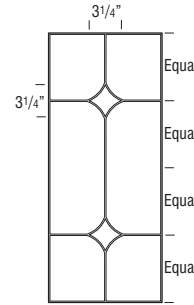
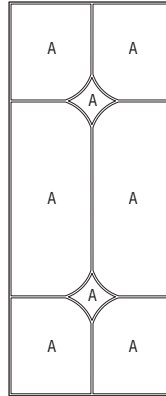

Heights > 9"  
Two Stars



Heights 6" to 9"  
One Star

Minimum Size  
6" x 6"

Glass Type:

- A) Seedy Clear 100Sdy

Metal Type:

3/16" H-Ch Zinc Proglaze2 (all)

## Lanai

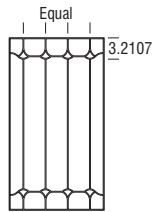
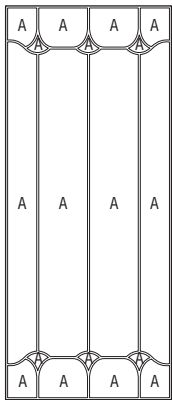

Widths > 16"  
4 Vertical Columns



Widths > 11" to 16"  
3 Vertical Columns



Widths 6" to 11"  
2 Vertical Columns

Glass Type:

- A) 1/8" Clear

Metal Type:

3/16" H-Ch Zinc Proglaze2 (all)

## Lyndhurst

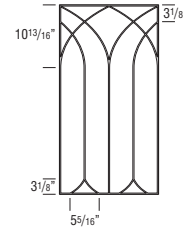
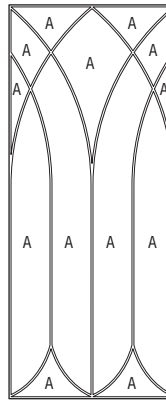

Widths > 11"  
3 Vertical Bars  
Equally Spaced

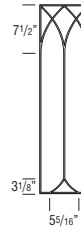

Widths 6" to 11"  
1 Vertical Bar  
Centered

Glass Type:

- A) Clear Rough Rolled 100RR

Metal Type:

3/16" H-Ch Zinc Proglaze2 (all)  
Black Patina Finish

Minimum Size 6" x 12"

# ART GLASS PANELS

## Pavillion

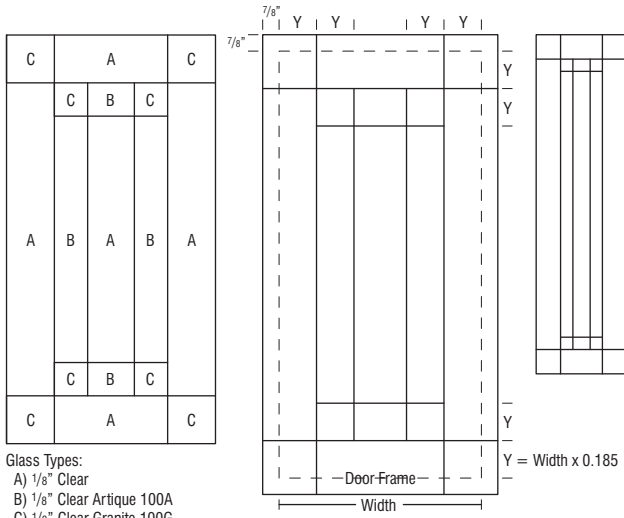

Glass Types:  
 A) 1/8" Clear  
 B) 1/8" Clear Artique 100A  
 C) 1/8" Clear Granite 100G

Metal Type:  
 3/16" H-Ch Round Zinc Proglaze2 (all)

- Suggested to use with Square doors.

## Quincy

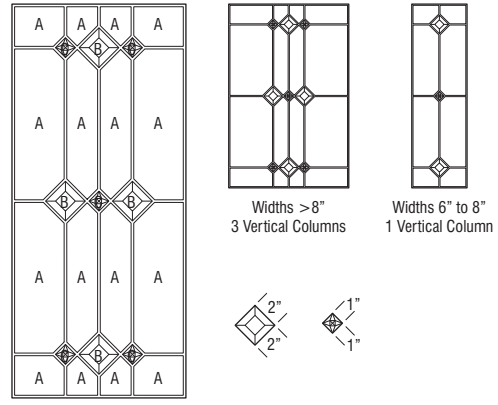

Glass Types:  
 A) Clear Waterglass 100W  
 B) 3/16" Clear with 1/2" Bevel  
 C) Clear Faceted Jewel

Metal Type:  
 3/16" H-Ch Zinc Proglaze2 (all)

Minimum Size 6" x 10"

- Suggested to use with Square doors.

## Portico

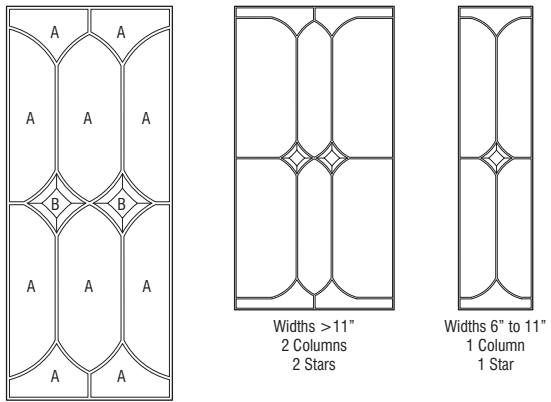

Glass Types:  
 A) 1/8" Clear  
 B) 3/16" Clear with 1/2" Bevel

Metal Type:  
 3/16" H-Ch Zinc Proglaze2 (all)  
 Black Patina Finish

Minimum Size 6" x 12"

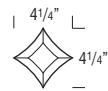

## Waterbury

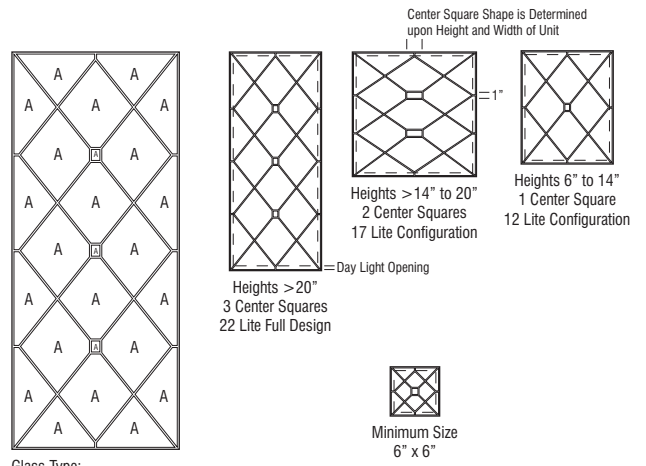

Glass Type:  
 A) Clear Waterglass 100W

Metal Type:  
 3/16" H-Ch Zinc Proglaze2 (all)  
 Black Patina Finish

# ART GLASS PANELS

## Wickford

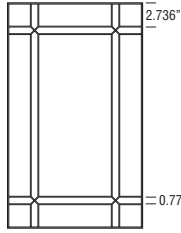
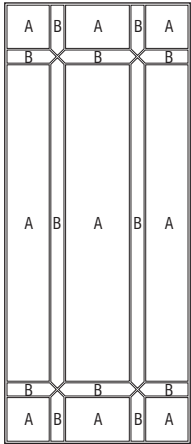

Widths >9"  
2 Vertical Columns



Widths 6 1/2" to 9"  
1 Vertical Column  
Centered



Minimum Size  
6 1/2" x 10"

Glass Types:  
A) Clear Artique 100A  
B) Clear Granite 100G

Metal Type:  
3/16" H-Ch Round Zinc Proglaze2 (all)

- Suggested to use with Square doors.

## INSTALLED TEXTURED GLASS PANELS



Antique



Bevel



Centurian



Clear



Cocoa Rice Paper

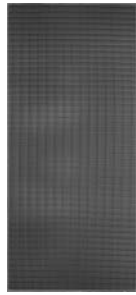

Cross Reeded



Frost



Hammered

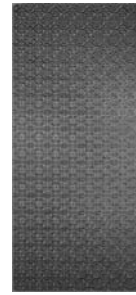

Morisco

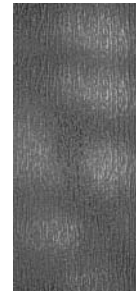

Rain

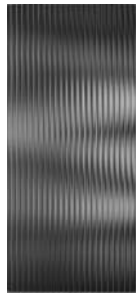

Reeded



Rice Paper



Seeded



Silhouette

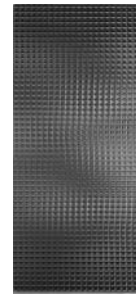

Strelli

- Textured glass panels available in Catalina only when Mullion Door is ordered because Cut-for-glass Door is not available.
- Cut-for-glass door must be ordered separately. See page 58.
- For glass shelf kits, see pages 420-421.
- On order acknowledgment, decorative glass selection will be shown with selected CG modification.
- When textured glass is ordered for use in wall top hinge (WTH) or wall vertical-lift (WVL) cabinets, glass design will be turned horizontally and may not match desired pattern.
- All glass is fully tempered or has a safety lamination.
- Textured glass panels will be factory installed when ordered with a CG door.
- Door frame may reduce amount of glass shown.
- No changes or cancellations will be accepted after 24 hours from acknowledgment of order.

# INSTALLED TEXTURED GLASS PANELS

## Antique



- Glass type: Antique
- Panel thickness: 1/8"

## Centurian

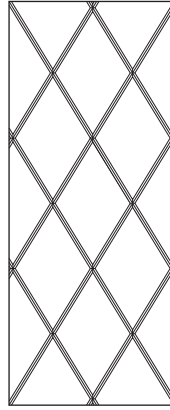

Maximum Size 24" x 48"

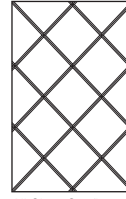

All Sizes Configured to 17 Lite



Minimum Size  
7 1/2" x 8"

- Glass type: Frost Etch
- Panel thickness: 1/8"

## Bevel

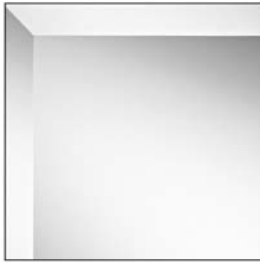

- Glass type: Clear
- Panel thickness: 1/4"
- Suggested to use with Square doors.
- Not compatible with Mullion Doors.

## Clear

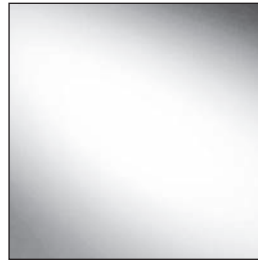

- Glass type: Clear
- Panel thickness: 1/8"

## Cocoa Rice Paper

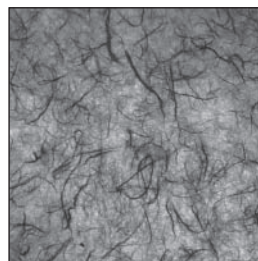

- Glass type: Cocoa Rice Paper
- Panel thickness: 9/32"

# INSTALLED TEXTURED GLASS PANELS

## Cross Reeded

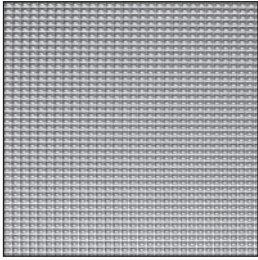

- Glass type: Cross Reeded
- Panel thickness: 5/32"

## Morisco

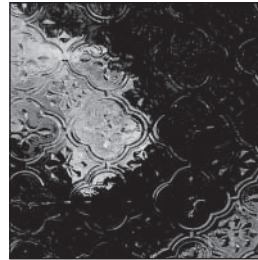

- Glass type: Morisco
- Panel thickness: 1/8"

## Frost

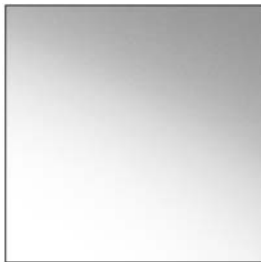

- Glass type: Frost
- Panel thickness: 5/32"

## Rain

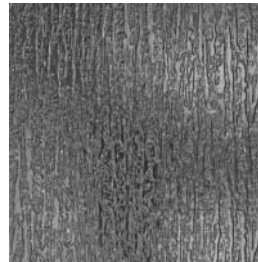

- Glass type: Rain
- Panel thickness: 5/32"

## Hammered



- Glass type: Hammered
- Panel thickness: 5/32"

## Reeded

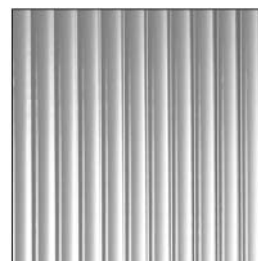

- Glass type: Reeded
- Panel thickness: 5/32"

# INSTALLED TEXTURED GLASS PANELS

## Rice Paper

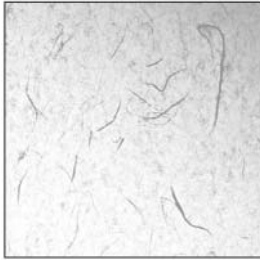

- Glass type: Rice Paper
- Panel thickness: 9/32"

## Silhouette

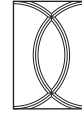
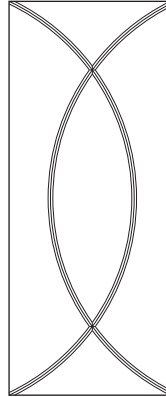

Minimum Size  
6" x 8 1/2"

- Glass type: Frost Etch
- Panel thickness: 1/8"
- Suggested to use with Square doors.

## Seeded

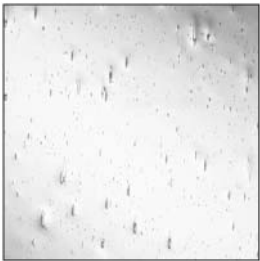

- Glass type: Seeded
- Panel thickness: 9/32"

## Strelli

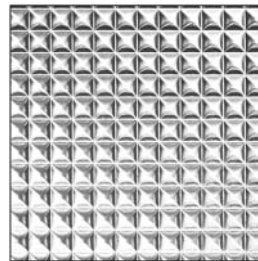

- Glass type: Strelli
- Panel thickness: 5/32"



# ART & TEXTURED GLASS PANELS

## ART GLASS PANELS

STYLE	PANEL THICKNESS	CAMING MATERIAL
Anson	1/4"	Zinc Black Patina
Avondale	1/4"	Zinc
Cambridge	1/4"	Zinc Black Patina
Charlotte	1/4"	Zinc
Ellington	1/4"	Zinc
Lanai	1/4"	Zinc
Lonsdale	1/4"	Zinc
Lyndhurst	1/4"	Zinc Black Patina
Pavillion	1/4"	Zinc
Portico	1/4"	Zinc Black Patina
Quincy	1/4"	Zinc
Waterbury	1/4"	Zinc Black Patina
Wickford	1/4"	Zinc

## TEXTURED GLASS PANELS

STYLE	PANEL THICKNESS
Antique	1/8"
Bevel	1/4"
Centurian	1/8"
Clear	1/8"
Cocoa Rice Paper	9/32"
Cross Reeded	5/32"
Frost	5/32"
Hammered	5/32"
Morisco	1/8"
Rain	5/32"
Reeded	5/32"
Rice Paper	9/32"
Seeded	9/32"
Silhouette	1/8"
Strelli	5/32"

# CABINET DIMENSIONS

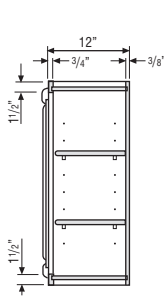

**WALL CABINET**

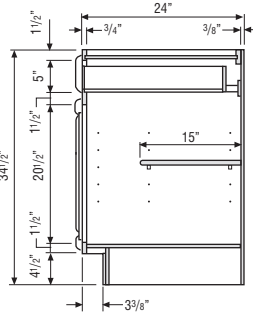

**BASE CABINET**

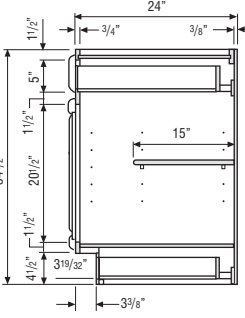

**BASE CABINET  
with TOEKICK DRAWER**

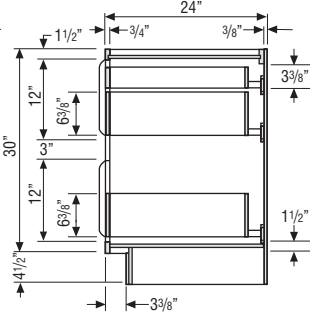

**TWO-DRAWER  
BASE CABINET  
with ROLL TRAY**

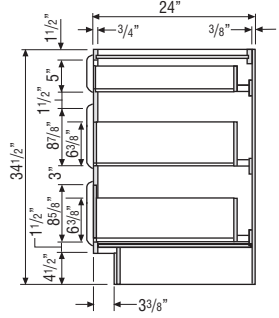

**THREE-DRAWER  
BASE CABINET**

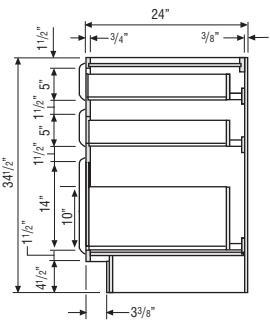

**THREE-DRAWER  
BASE CABINET  
with DEEP DRAWER**

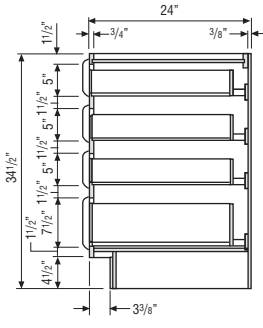

**FOUR-DRAWER  
BASE CABINET**

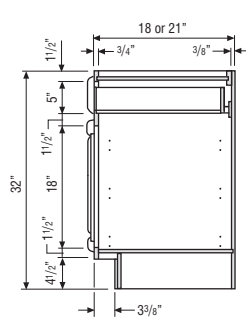

**32" HIGH  
VANITY CABINET**

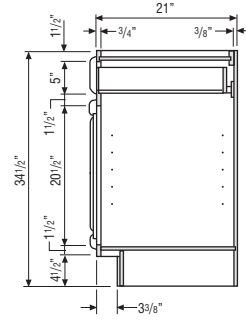

**34 1/2" HIGH  
VANITY CABINET**

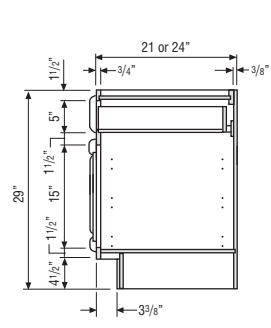

**DESK BASE CABINET**

# CABINET DIMENSIONS

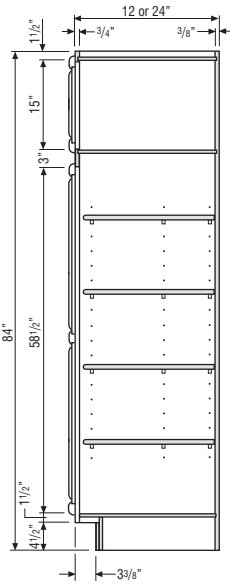

**UTILITY CABINET**

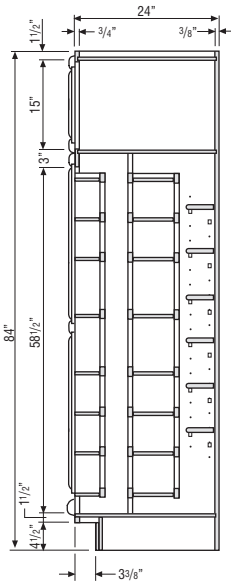

**PANTRY CABINET**

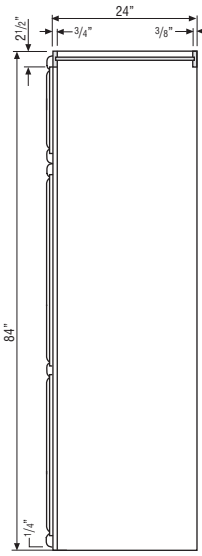

**PANTRY  
WALK-THROUGH**

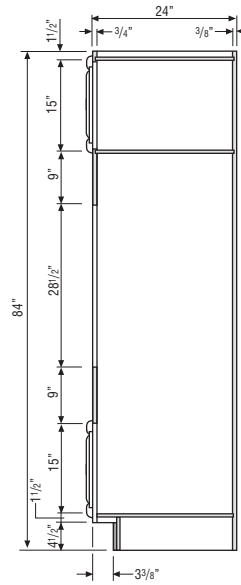

**SINGLE  
OVEN CABINET**

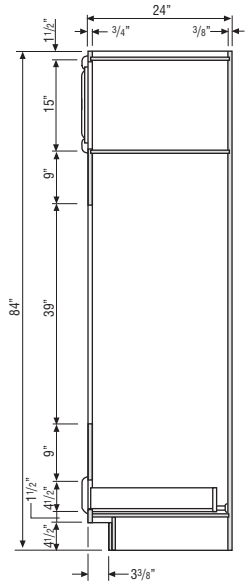

**DOUBLE  
OVEN CABINET**

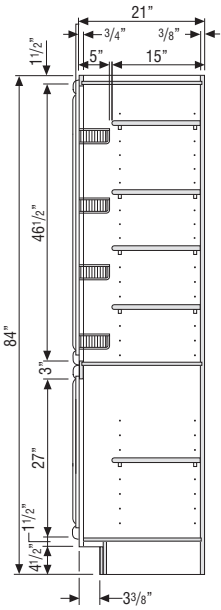

**LC/LCRH**

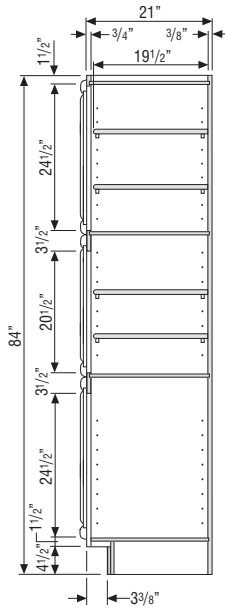

**VANITY UTILITY**

# CABINET DIMENSIONS

## ROLL TRAY POSITIONS

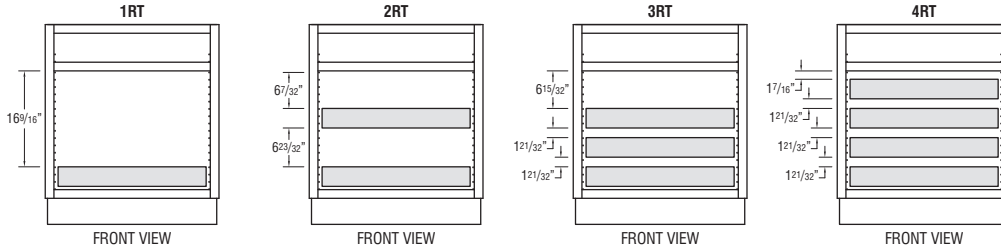

## BASE CABINETS AND 34 1/2" HIGH VANITY CABINETS

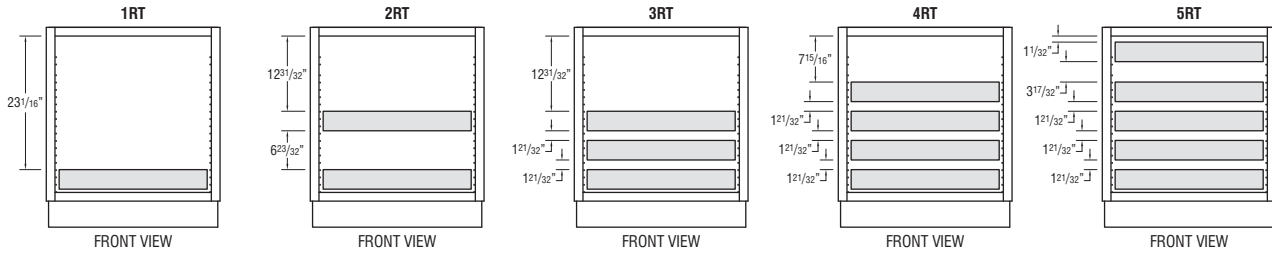

## FULL HEIGHT BASE CABINETS

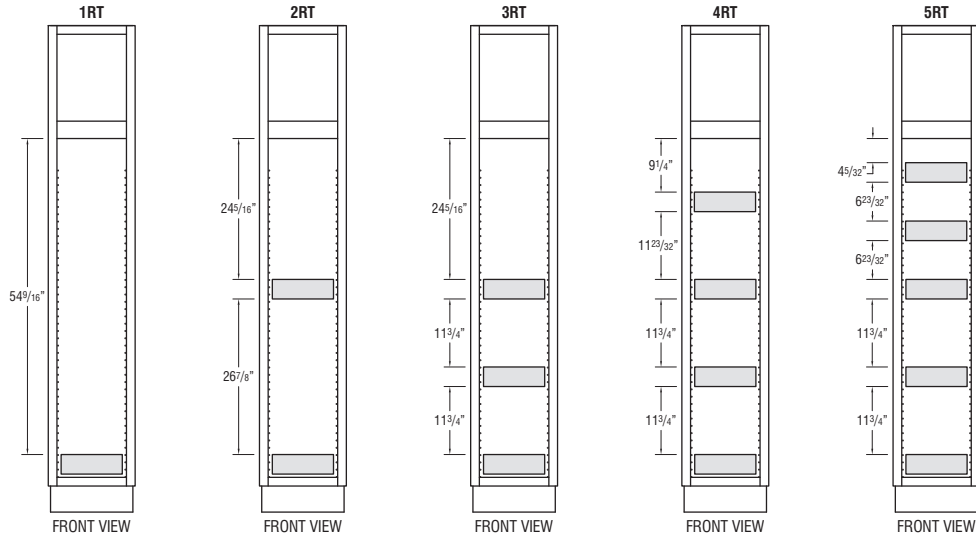

## UTILITY CABINETS

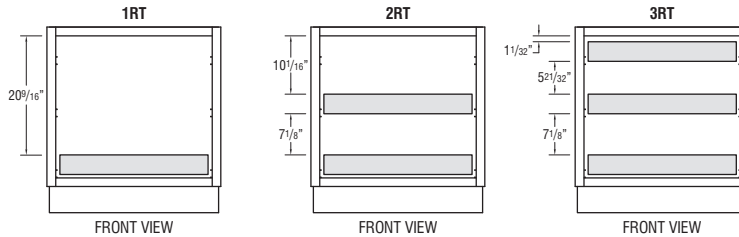

## 32" HIGH VANITY CABINETS

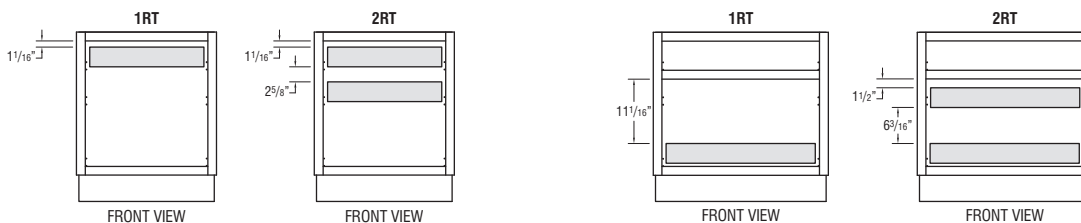

## PRINTER BASE CABINETS

## DESK DOOR DRAWER BASE CABINETS

# CABINET DIMENSIONS

## 84" HIGH APPLICATION

Number after Wall Cabinet Represents Height of Cabinet

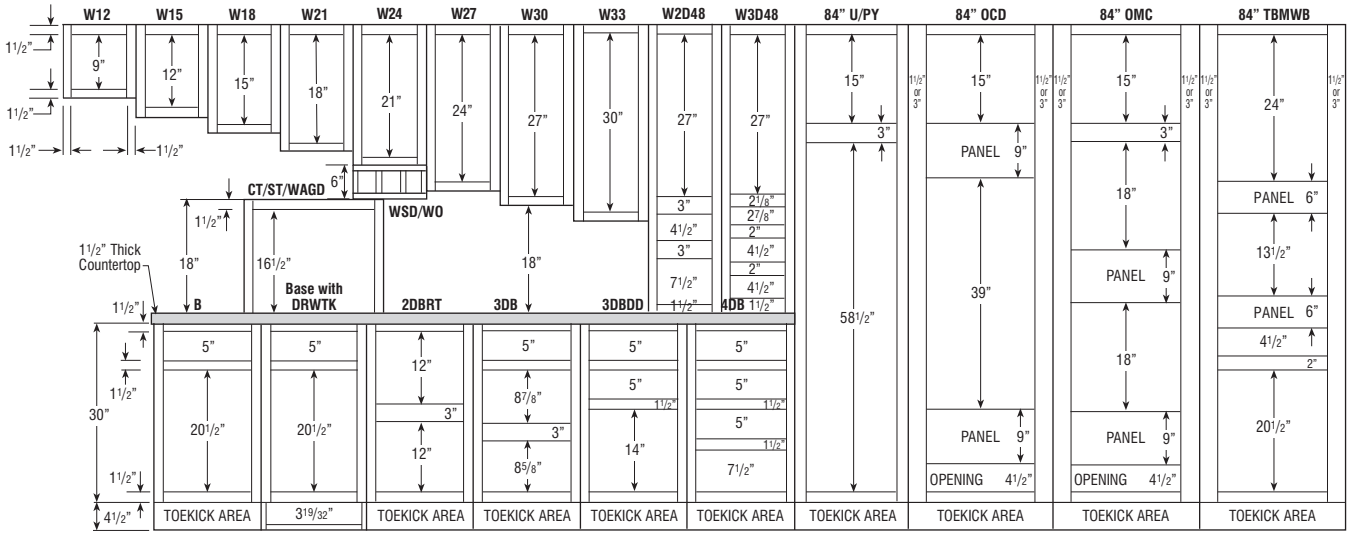

## 87" HIGH APPLICATION

Number after Wall Cabinet Represents Height of Cabinet

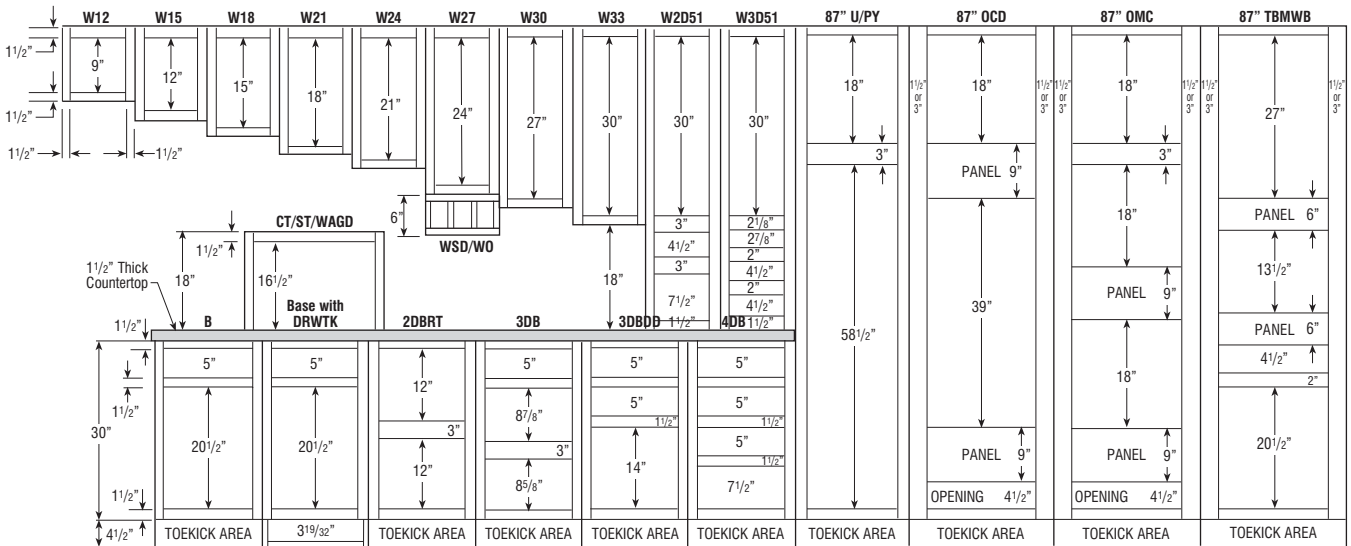

- 1 1/2" Top and Bottom Rails - Wall and Base Cabinets.
- 1 1/2" Vertical Stiles.
- 3" Center Vertical Rails on Wall and Base Cabinets to Divide Double Door Cabinets on 39" Wide and Over.

### Full Overlay Door Styles:

- 1/4" Reveal Around Doors (1/4" of Face Frame Shows).
- Frame Opening + 2 1/2" = Door Size for Base/Wall Cabinets.
- 4 1/2" or 5" High Drawer Opening = 6 1/4" Drawer Front.
- 7 1/2" High Drawer Opening = 10" Drawer Front.
- 8 5/8" and 8 7/8" Drawer Opening = 11 3/8" Drawer Front.

### 1/2" Overlay Door Styles:

- 1" Reveal Around Doors (1" of Face Frame Shows).
- Frame Opening + 1" = Door Size for Base/Wall Cabinets.
- 4 1/2" or 5" High Drawer Opening = 5 1/2" Drawer Front.
- 7 1/2" High Drawer Opening = 8 1/2" Drawer Front.
- 8 5/8" and 8 7/8" Drawer Opening = 9 7/8" Drawer Front.

# CABINET DIMENSIONS

## 90" HIGH APPLICATION

Number after Wall Cabinet Represents Height of Cabinet

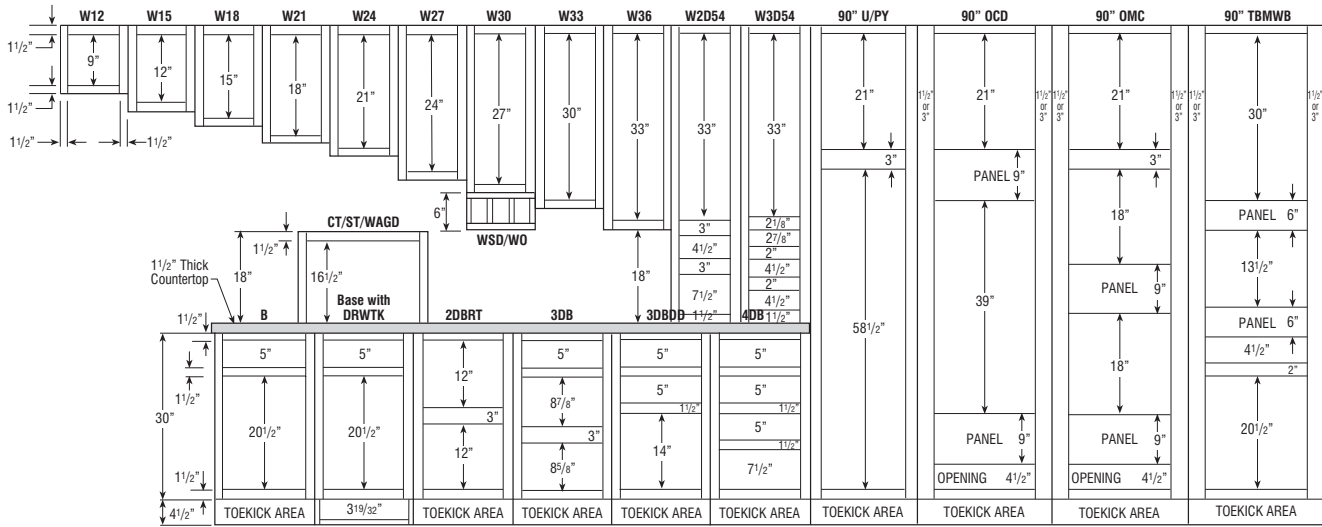

## 93" HIGH APPLICATION

Number after Wall Cabinet Represents Height of Cabinet

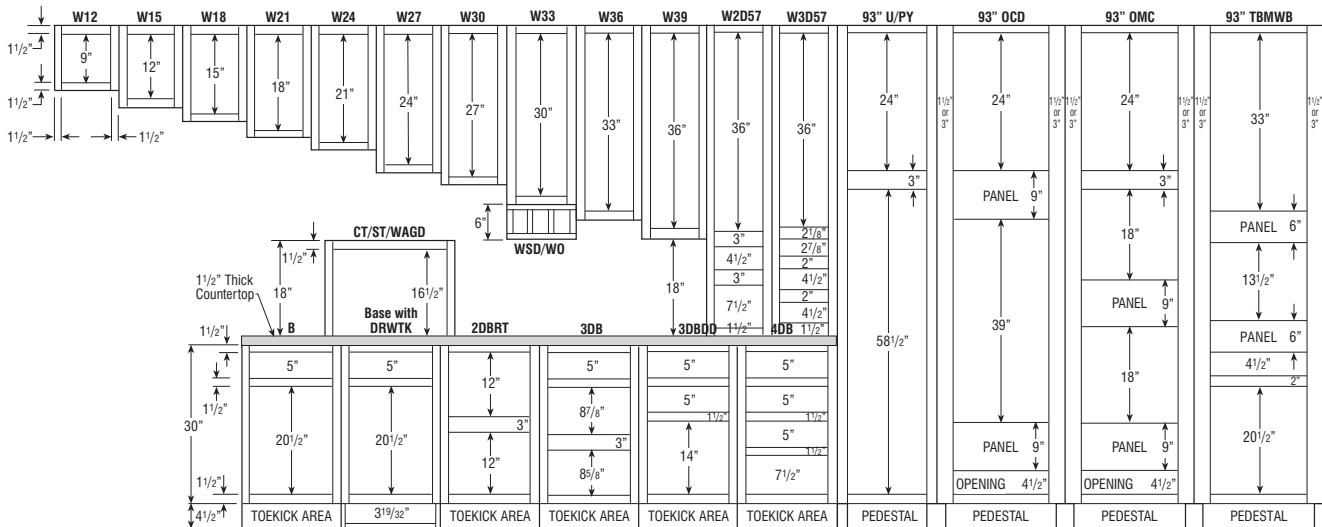

- 1 1/2" Top and Bottom Rails - Wall and Base Cabinets.
- 1 1/2" Vertical Stiles.
- 3" Center Vertical Rails on Wall and Base Cabinets to Divide Double Door Cabinets on 39" Wide and Over.

### Full Overlay Door Styles:

- 1/4" Reveal Around Doors (1/4" of Face Frame Shows).
- Frame Opening + 2 1/2" = Door Size for Base/Wall Cabinets.
- 4 1/2" or 5" High Drawer Opening = 6 1/4" Drawer Front.
- 7 1/2" High Drawer Opening = 10" Drawer Front.
- 8 5/8" and 8 7/8" Drawer Opening = 11 3/8" Drawer Front.

### 1/2" Overlay Door Styles:

- 1" Reveal Around Doors (1" of Face Frame Shows).
- Frame Opening + 1" = Door Size for Base/Wall Cabinets.
- 4 1/2" or 5" High Drawer Opening = 5 1/2" Drawer Front.
- 7 1/2" High Drawer Opening = 8 1/2" Drawer Front.
- 8 5/8" and 8 7/8" Drawer Opening = 9 7/8" Drawer Front.

# CABINET DIMENSIONS

## 96" HIGH APPLICATION

Number after Wall Cabinet Represents Height of Cabinet

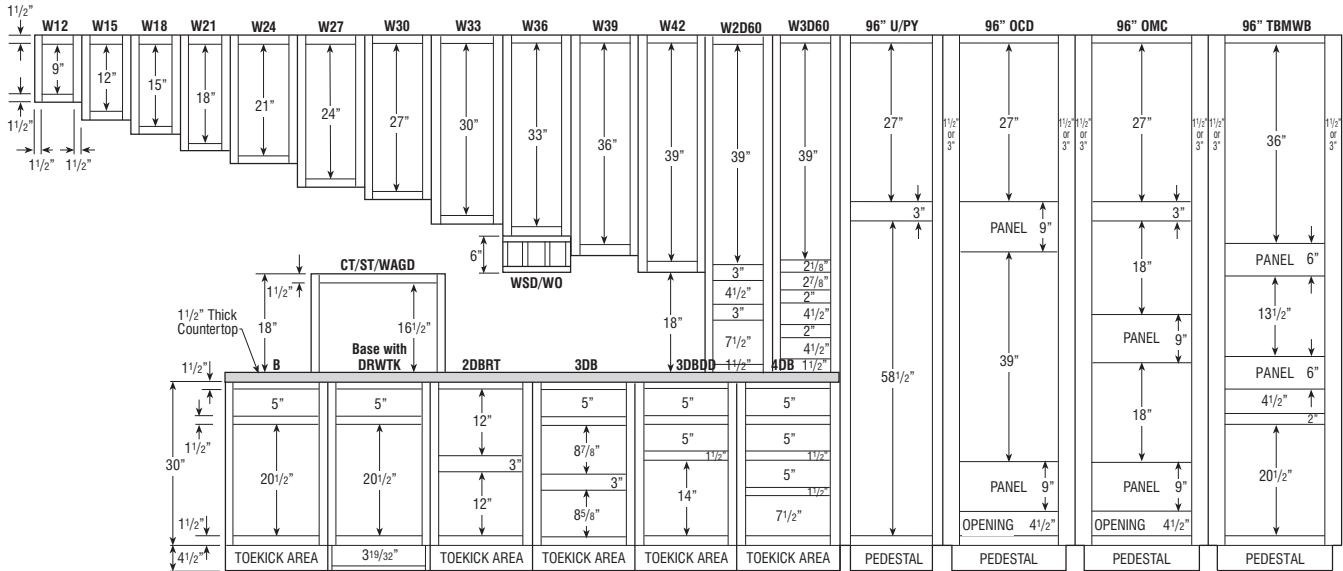

### 5-PIECE DRAWER FRONT DIMENSIONS CHART

5-PIECE DRAWER FRONTS	DRAWER FRONT WIDTH	DRAWER FRONT HEIGHT	PANEL FLAT WIDTH	PANEL FLAT HEIGHT
Anden	8 1/2"	6 1/4"	3 5/8"	1 3/8"
Bailey DFF5PC	8 1/2"	6 1/4"	3 1/2"	1 1/4"
Breman DFF5PC	8 1/2"	6 1/4"	2 1/2"	1 3/4"
Caldera	8 1/2"	6 1/4"	2 1/2"	1 3/4"
Carson DFR5PC	8 1/2"	6 1/4"	1 5/8"	1 1/8"
Davis	8 1/2"	6 1/4"	3 1/2"	1 1/4"
Julien	8 1/2"	6 1/4"	2 1/2"	1 3/4"
LaGrange	8 1/2"	6 1/4"	3 1/2"	1 1/4"
Laureldale	8 1/2"	6 1/4"	3 1/2"	1 1/4"
Leeton	8 1/2"	6 1/4"	4 1/4"	2"
Liberty DFF5PC	8 1/2"	6 1/4"	4"	3 1/4"
Montgomery	8 1/2"	6 1/4"	4"	3 1/4"
Rothshire	8 1/2"	6 1/4"	3 1/2"	1 1/4"
Selena DFF5PC	8 1/2"	6 1/4"	3 1/2"	1 1/4"
Shiloh DFF5PC	8 1/2"	6 1/4"	2 1/8"	2 1/8"
Sullivan DFR5PC	8 1/2"	6 1/4"	1 1/4"	1"
Sumner DFF5PC	8 1/2"	6 1/4"	2 1/2"	1 3/4"
Wells	8 1/2"	6 1/4"	3 1/2"	1 1/4"
Worthen	8 1/2"	6 1/4"	2 1/2"	1 3/4"

Drawer sizes are representative of a 9" wide base cabinet.

# CABINET DIMENSIONS

## 29" HIGH DESK CABINETS

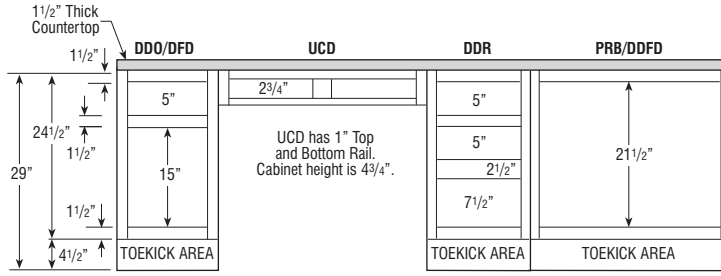

## 32" HIGH VANITY CABINETS

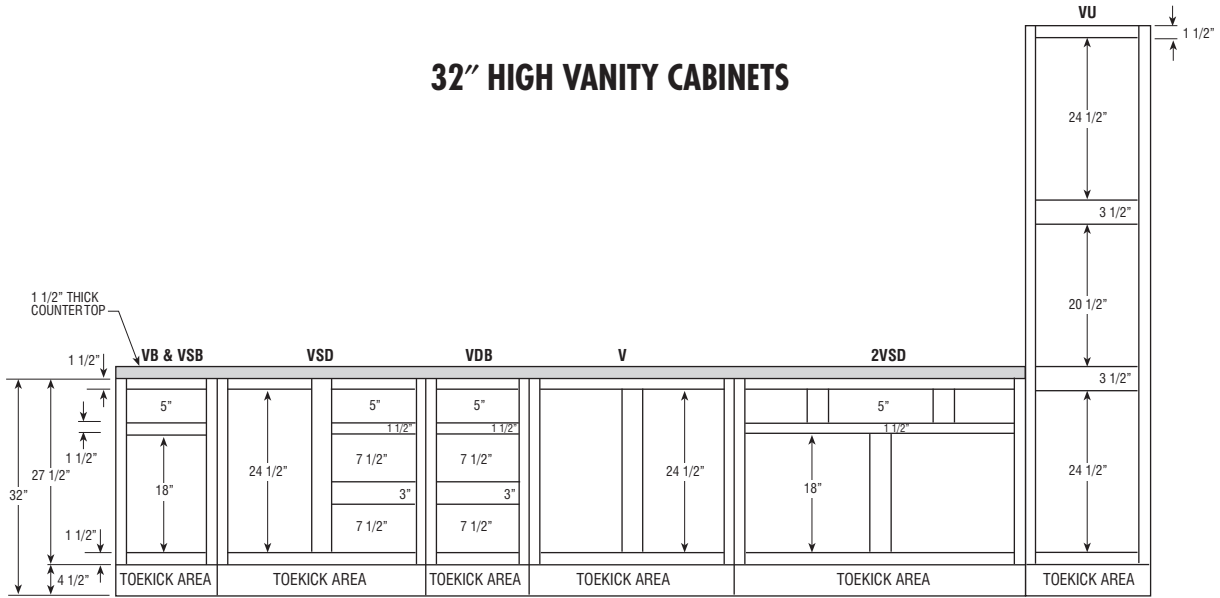

## 34 1/2" HIGH VANITY CABINETS

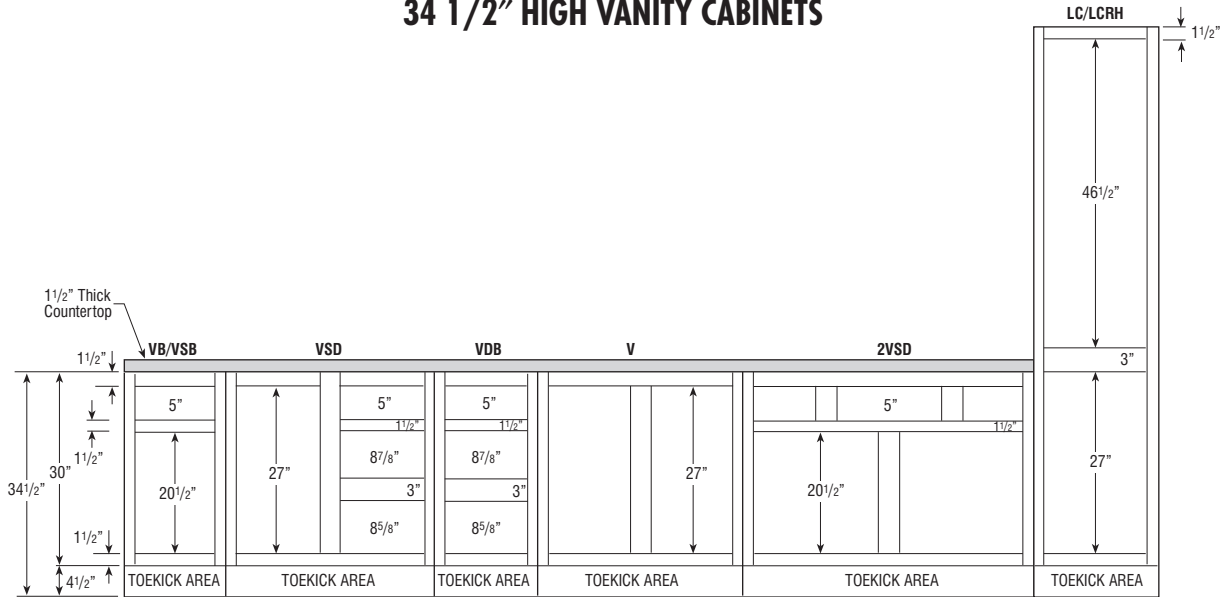



# CABINET DIMENSIONS

## DIMENSIONS FOR CORNER INSTALLATIONS (45° DIAGONAL)

### 12" DEEP CABINETS

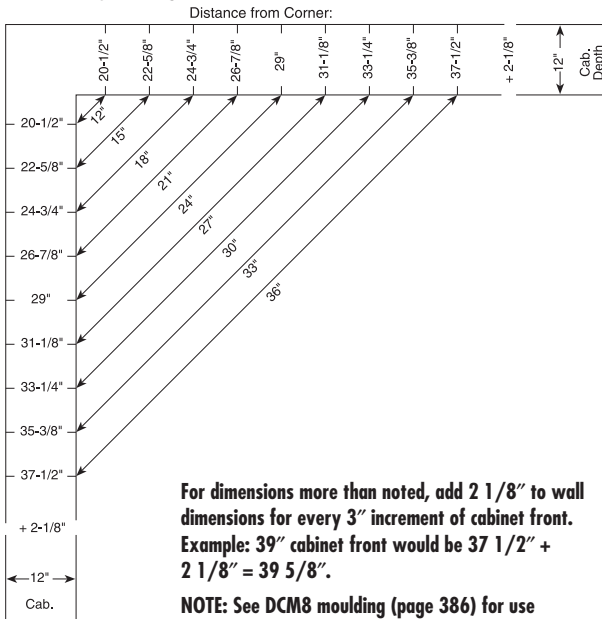

For dimensions more than noted, add 2 1/8" to wall dimensions for every 3" increment of cabinet front.  
 Example: 39" cabinet front would be 37 1/2" + 2 1/8" = 39 5/8".  
**NOTE:** See DCM8 moulding (page 386) for use between cabinets adjacent to 45° corner installations.

### 24" DEEP CABINETS

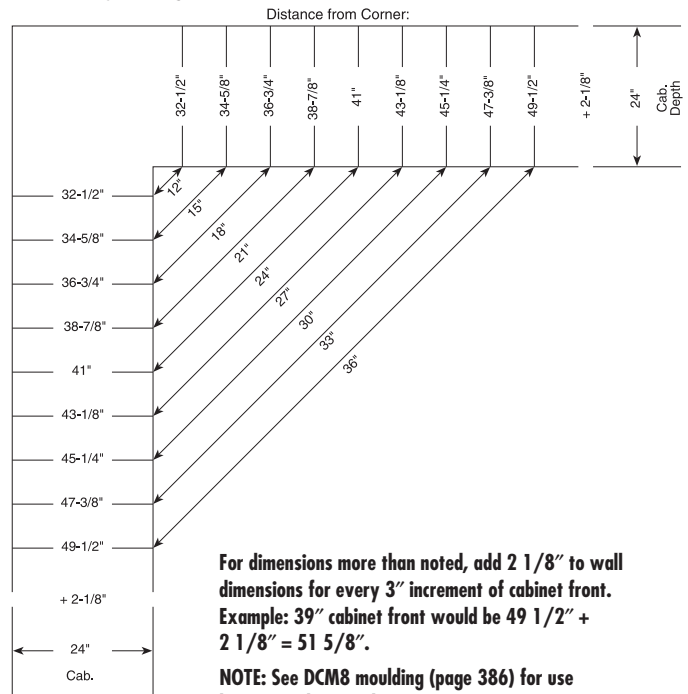

For dimensions more than noted, add 2 1/8" to wall dimensions for every 3" increment of cabinet front.  
 Example: 39" cabinet front would be 49 1/2" + 2 1/8" = 51 5/8".  
**NOTE:** See DCM8 moulding (page 386) for use between cabinets adjacent to 45° corner installations.

## INSTALLATION HEIGHT REQUIREMENTS

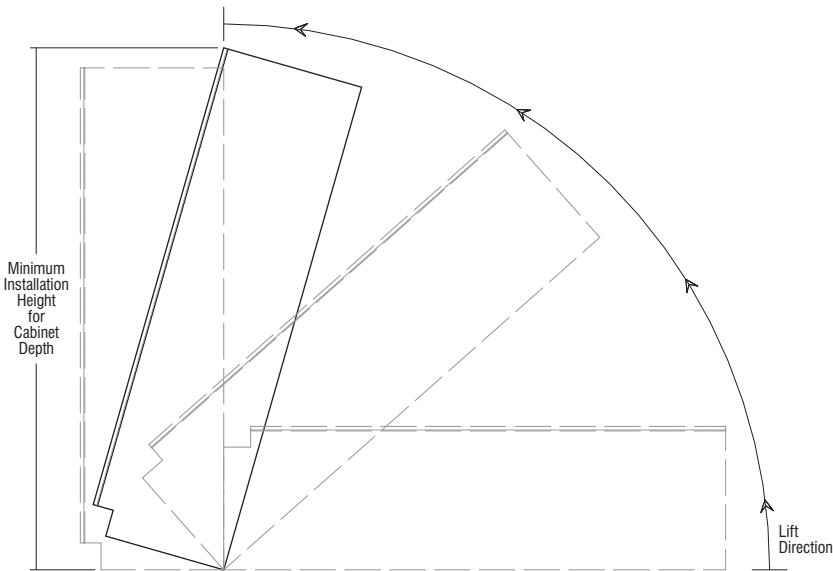

Height of ceiling needs to be considered for installation of tall cabinets. Cabinet height below includes toekick area:

Cabinet Height	Minimum Installation Height for Cabinet Depth					
	12"	15"	18"	21"	24"	27"
84"	84 7/8"	85 11/32"	85 15/16"	86 19/32"	87 3/8"	88 1/4"
87"	87 27/32"	88 5/16"	88 27/32"	89 1/2"	90 1/4"	91 3/32"
90"	90 13/16"	91 1/4"	91 13/16"	92 7/16"	93 5/32"	93 31/32"
93"*	89 5/16"	89 25/32"	90 5/16"	90 31/32"	91 23/32"	92 17/32"
96"*	92 5/16"	92 3/4"	93 9/32"	93 29/32"	94 5/8"	95 13/32"
93" PWT..	—	—	—	95 11/32"	96 1/16"	96 27/32"
96" PWT..	—	—	—	98 9/32"	98 31/32"	99 3/4"

\*Separate pedestal base included with cabinet to be installed after cabinet is in an upright position.

# DIAMOND CABINETRY'S DESIGN CHECKLIST

## CONSTRUCTION OPTIONS

Consider exposed end options:

- Modify exposed cabinet ends to PE or APC.
- Adding a veneer finished end (FB) will age uniformly with the rest of the kitchen.
- Apply 1/4" skin to hide 1/4" reveal. This will allow the ends to age uniformly with the rest of the kitchen and will make it flush.
- Apply decorative door kit (BED, WED, TED). This kit includes 1/4" skin, decorative doors, and screws for field installation.
- Upgrade exposed cabinet ends with Authentic Ends (AUTHL/AUTHR) or Furniture Finished Plywood Ends (FPFB) Modification.

## WOOD AND FINISH CHARACTERISTICS

Review specific details with the customer:

- Mineral Streaks, Birdseye Dots, Grain Variations (especially Hickory and Rustic Alder).
- Color Variations/Darkening (especially Natural/Light Cherry).
- Finish Variations (Glazes are "consistently inconsistent"), hairline cracks may develop at frame joints on painted frame.
- Underside of cabinets are Natural Maple. Use light rail or cabinet panel edge and skin to hide, especially when designing with peninsula wall cabinets. For cabinets that are bridged between taller adjacent cabinets, specify PFINBTMB modification. See page 45 for more details.

## LOGIX®

Review storage and usage needs with Customer. See chart on pages 83-84 for more Logix®.

- Cooking Solutions:
  - Wall Spice Rack Cabinet
- Storage Solutions:
  - SuperCabinet™
  - Base Rotating Deep Bin
  - Pegged Dish Organizer
  - Wall Message Center
- Clean-up Center:
  - Trash/Recycle Basket Base

## CLEARANCES

- Add fillers between end cabinets and walls on full overlay door styles.
- Allow space between door/window trim and end cabinets for countertop and top moulding overhang.
- Include refrigerator door hinges in overall refrigerator height when placing cabinets above it.

Maintain a minimum clearance of 3" by pulling blind corners as follows:

- Full Overlay: 1 1/4", Standard Overlay 1/2". (More is needed in certain situations such as when adjacent to an appliance or when using oversized pulls or knobs.)
- Allow sufficient clearance (3") on each side of accessory cabinets (such as roll-out trays, swing-out units, etc.). Doors on these cabinets must open fully for accessories to be functional.
- Ensure the height between the cooktop and range hood is 24" to meet NKBA guidelines.

Qualify customer carefully on upper cabinet/microwave advantages/disadvantages as follows:

- Minimum of 18" from cooktop to upper cabinet/above the range microwave which allows for easy access to either, but less room over back burner.
- Minimum of 21" from cooktop to upper cabinet/microwave which allows for access to large pots on back burner of cooktop, but longer reach to microwave.

## FILLERS

- Place fillers toward end of run where least conspicuous if needed.
- Attach overlay fillers on top of the base, wall, or tall fillers when using full overlay door styles to maintain a consistent reveal. Don't forget to include blind corner fillers.
- Add a filler at least 6" wide to accommodate a decorative onlay when the filler is used as valance.

## VARYING HEIGHTS AND DEPTHS

- Also increase the depth of a wall cabinet run when you increase the height (so moulding on adjacent cabinet will fill into the side of the taller cabinet).
- Skin the sides of tall cabinets to keep adjacent base and wall cabinets out from reveal of tall cabinet.
- Add increased depth on tall end panels for a built-in look for deep refrigerators.
- Account for the additional support needed for wall cabinets with a depth of 18" or greater. This can be achieved by installing a soffit or end panels.

## MATCHING INTERIOR CABINETS/GLASS OPTIONS

- Verify cut-for-glass or mullion door option is available on desired cabinet size. (See pages 58-61 for available cut-for-glass/mullion door sizes.)
- Verify glass insert option is available for desired cut-for-glass door size chosen.
- Verify matching interior option has been selected for all open or glass cabinets.
- Verify mullion door lite grid matches customer expectations.

## MOULDINGS

- Order rosettes and plinths in beaded or fluted styles to match fillers.
- Verify correct amount of crown moulding has been ordered.
- Order toekick caps.
- Order extra scribe.

## ISLANDS AND PENINSULAS

- Consider standard height bars are 34 1/2" tall and require 19" knee space. Raised bars are 42" tall.
- Consider base peninsula cabinets (P) are 24 1/4" deep and require 12" of knee space. Use back panels/doors to flush non-P cabinets with P cabinets.
- Use recess toe on sides and back or BBM8 when using multiple base cabinets to create an island.
- Use outside corner moulding if a skin is exposed on the back of the island.

## APPLIANCES

- Note for all consumers, appliances are not included with any cabinetry product.
- Do not place dishwashers next to diagonal front cabinet (interference) or next to a range (no countertop support).
- Verify refrigerator door has enough clearance to open beyond 90° so refrigerator drawers can be utilized. Refer to appliance manufacturer's specs.
- Add TF696FH, as it may be required to frame around built-in microwave ovens and other built-in items. Refer to appliance manufacturer's specs.
- Order appliance panels.

## SPECIAL CONSIDERATIONS

- Consider V-groove skins and/or decorative doors on exposed cabinet sides in glazed kitchen.

## MISCELLANEOUS

- Order full size touch-up kit (mini touch-up kit included with standard sink base).

## TIPS TO THE INSTALLER

#10 x 2 1/2" installation screws are furnished and packaged inside all cabinets. Proper wall stud or ceiling joist installation is essential for Wall and Peninsula cabinets to support weight. Whenever possible, cabinets should be attached to each other for additional strength. Excessive weight should not be put on cabinets hung by themselves. Shimming may be required to ensure proper alignment. Wallboard alone is not strong enough to support the cabinets.

Our Warranty does not cover damage caused by improper installation. Please be sure to install cabinets properly. If you have questions, please contact your representative or customer service.

## kitchen planning guidelines

### DOOR/ENTRY

- Door opening should be at least 32" wide, requiring a minimum 2' 10" wide door.

### DOOR INTERFERENCE

- Entry door should not interfere with safe appliance operation or appliance doors.

### DISTANCE BETWEEN WORK CENTERS

- With three work centers, the total distance traveled should not be more than 26' with no single leg of the triangle less than 4' or more than 9'.
- With more than three work centers, each additional travel distance to another work center should be no less than 4' or more than 9'. Each leg is measured from the center-front of the appliance/sink. No work triangle leg should intersect an island/peninsula by more than 12".

### SEPARATING WORK CENTERS

- A tall obstacle should not separate two primary work centers. A properly recessed tall corner unit is acceptable.

### WORK TRIANGLE TRAFFIC

- Major traffic patterns should not cross through the basic work triangle.

### WORK AISLE

- The work aisle should be at least 42" for one cook and at least 48" for multiple cooks.

### WALKWAY

- The walkway width should be at least 36".

### TRAFFIC CLEARANCE AT SEATING

- Allow 32" of clearance from the table to wall/obstacle if no traffic passes behind a seated diner. If traffic passes behind the diner, allow at least 36" to edge past or 44" to walk past.

### SEATING CLEARANCE

- 30" high tables/counters should allow a 24" wide by 18" deep space for each seated diner and at least 18" knee space.
- 36" high counters should allow a 24" wide by 15" deep space for each seated diner and at least 15" kneespace.
- 42" high counters should allow a 24" wide by 12" deep space for each seated diner and at least 12" kneespace.

### CLEAN-UP/PREP SINK PLACEMENT

- With only one sink, locate it adjacent to or across from the cooking surface and refrigerator.

### CLEAN-UP/PREP SINK LANDING AREA

- Include at least a 24" wide landing space on one side of the sink and 18" on the other.
- If all the countertop at the sink is not the same height, plan a 24" landing space on one side of the sink and 3" of countertop frontage on the other, both at the same height of the sink.

### PREPARATION/WORK AREA

- Include a section of countertop at least 36" wide x 24" deep next to the sink for a work area.

### DISHWASHER PLACEMENT

- Nearest edge of dishwasher should be within 36" of nearest edge of sink. Provide at least 21" of standing space between the edge of the dishwasher and countertop frontage/appliances/cabinets which are placed at a right angle to the dishwasher.

### WASTE RECEPTACLES

- Include at least 2 waste receptacles, one near the sink and the other nearby for recycling.

### AUXILIARY SINK

- Provide at least 3" of countertop frontage on one side of the auxiliary sink and 18" on the other side, both at the same height as the sink.

### REFRIGERATOR LANDING AREA

- Include at least 15" of landing area on the handle side of the refrigerator, 15" on either side of a side-by-side refrigerator, 15" of landing space which is no more than 48" across from the front of the refrigerator, and 15" above or adjacent to any under-counter style refrigerator.

### COOKING SURFACE LANDING AREA

- Include a minimum of 12" of landing area on one side of the cooking surface and 15" on the other.
- If cooking surface is at a different countertop height than the rest of the kitchen, then the 12" and 15" landing areas must be the same height as the cooking surface.
- For safety reasons, in an island or peninsula situation, the countertop should extend a minimum of 9" behind the cooking surface if the counter height is the same height as the cooking surface.

### COOKING SURFACE CLEARANCE

- Allow 24" between the cooking surface and a protected noncombustible surface above it.
- At least 30" of clearance is required between the cooking surface and an unprotected/combustible surface above it.
- If a microwave/hood combination is used, then the manufacturer's specifications should be followed.

### COOKING SURFACE VENTILATION

- A correctly sized, ducted ventilation system is recommended for all cooking surface appliances. The recommended minimum is 150 CFM.
- Code requires that the manufacturer's specifications be followed. Minimum exhaust rate for a ducted hood is 100 CFM and must be ducted to the outside.
- Make-up air may need to be provided. Refer to local codes.

### COOKING SURFACE SAFETY

- Do not locate cooking surface under an operable window.
- Window treatments above cooking surface should not use flammable materials.
- Place a fire extinguisher near the kitchen exit away from cooking equipment.

### MICROWAVE OVEN PLACEMENT

- The ideal location for the bottom of the microwave is 3" below the principle user's shoulder, but no more than 54" above the floor.

### MICROWAVE LANDING AREA

- Provide at least 15" above, below, or adjacent to the handle side of a microwave oven.

### OVEN LANDING AREA

- Include at least 15" next to or above the oven.
- A 15" landing area that is not more than 48" away is also acceptable as long as the oven does not open into a walkway.

### COMBINING LANDING AREAS

- If two landing areas are adjacent to one another, determine a new minimum for the two by taking the longer of the two and adding 12".

*continued*

## kitchen planning guidelines (continued)

### COUNTERTOP SPACE

- A total of 158" of countertop frontage, 24" deep, with at least 15" clearance above is needed to accommodate all landing, preparation, work, and storage areas.

### COUNTERTOP EDGES

- Clipped or round corners, rather than sharp edges, are recommended on all counters.

### STORAGE

- The recommended total shelf/drawer frontage for a small kitchen (less than 150 square feet) is 1400", for a medium kitchen (151 to 350 square feet) is 1700", and for a large kitchen (greater than 350 square feet) is 2000".

Sizes:	S	M	L
Wall	300"	360"	360"
Base	520"	615"	660"
Drawer	360"	400"	525"
Pantry	180"	230"	310"
Misc.	40"	95"	145"

- The totals for wall, base, drawer, and pantry shelf/drawer frontage can be adjusted upward or downward as long as the recommended total stays the same.

### STORAGE AT CLEAN-UP/PREP SINK

- The recommended total for a small kitchen is 400", a medium kitchen is 480", a large kitchen is 560", and should be located within 72" of the centerline of the main clean-up/prep sink.

### CORNER CABINET STORAGE

- At least one corner cabinet should include a functional storage device.

### ELECTRICAL RECEPTACLES

- GFCI (Ground-Fault-Circuit-Interrupter) protection is required on all receptacles servicing countertop surfaces within the kitchen.

### LIGHTING

- Every work surface should be well illuminated. At least one wall switch-controlled light must be placed at the entrance.
- Window/skylight area, equal to at least 8% of the total square footage of the kitchen, or a total living space which includes a kitchen, is required.

## bathroom planning guidelines

### DOOR/ENTRY

- Doorway opening should be at least 32", requiring a minimum 2' 10" wide door.

### DOOR INTERFERENCE

- The door area should include clear floor space for maneuvering which varies according to the type of door and the direction of the approach.

### CEILING HEIGHT

- Bathroom floor to ceiling minimum height is 80". A shower or tub with a shower head shall have a minimum floor to ceiling height of 80" above a minimum area 30" x 30" at the shower head.

### CLEAR SPACE

- Plan a clear space of 30" from the front edge of all fixtures to any opposite bath fixture, wall, or obstacle.
- A minimum space of at least 21" is required in front of a lavatory, toilet, bidet, and tub, with a 24" minimum space in front of a shower entry.

### SINGLE LAVATORY PLACEMENT

- The distance from the centerline of the lavatory to the sidewall/tall obstacle should be at least 20".
- The minimum distance required is 15". The minimum distance required between a wall and the edge of a lavatory is 4".

### DOUBLE LAVATORY PLACEMENT

- The distance between the centerlines of two lavatories should be at least 36".
- The minimum distance required is 30".
- The minimum distance required between the edges of two lavatories is 4".

### LAVATORY/VANITY HEIGHT

- The height for a lavatory varies from 32" to 43" to fit the user.

### COUNTERTOP EDGES

- Clipped or round corners, rather than sharp edges, are recommended on all counters.

### SHOWER SIZE

- The interior shower size should be at least 36" x 36". The minimum interior shower size required is 30" x 30".

### STORAGE

- Provide adequate, accessible storage for toiletries, bath linens, grooming and general bathroom supplies.
- Storage of frequently used items should be 15" to 48" above floor.

### ELECTRICAL RECEPTACLES

- All GFCI receptacles should be located at electrical appliance points of use.

**Load bearing floors and shelves meet KCMA standards of 15 lbs. per square foot. Warranty does not cover overloading beyond this point.**

To view a complete and updated list of the NKBA Guidelines, visit <http://www.nkba.org/guidelines/default.aspx>

© Copyright 2010 National Kitchen & Bath Association

# LOGIX® REFERENCE CHART

Wall Cabinets	Description	3"	6"	9"	12"	15"	18"	21"	24"	27"	30"	33"	36"	39"	42"	45"	48"	Page
W18__SPD	Wall Spice Pull-down						•											148
W36__SHLFPD	Wall Shelf Pull-down												•					149
WBCPO__OL	Wall Box Column Pull-outs (Plain, Overlay)	•	•															144
WBCPOKUP3__OL	Wall Box Column Pull-outs w/K-Cup (Plain, Overlay)	•																146, 147
WEAS__	Wall Easy Access Storage Cabinets					•	•				•		•					108
WMC__	Wall Message Center	•																158
WSC__	Wine Storage Cabinet				•	•	•	•	•									154
WSP__	Wall Spice Pull-outs			•	•													148
WSR__	Wall Spice Rack Cabinets						•	•										150
<b>Hearths</b>																		
HPP9__21	Hearth Pier w/Pull-out			•														172
<b>Base Cabinets</b>																		
2DB__RT	Two Drawer Bases w/Roll Tray						•	•	•	•	•	•	•					230
2DB36PDO	Two Drawer Base w/Pegged Dish Organizer												•					230
2DB36RTPDO	Two Drawer Base w/Roll Tray & Pegged Dish Organizer												•					231
3DB__WTCO	Three Drawer Bases w/Wood Tiered Cutlery Divider Drawer					•	•	•	•									233
3DB18KCUP	Three Drawer Base w/Wood Tiered K-Cup Drawer					•												233
3DBBDD__	Three Drawer Base Buffet w/Deep Drawer										•	•	•					235
3DBDD__	Three Drawer Bases w/Deep Drawer								•		•	•	•					234
4DB__CIW	Four Drawer Bases w/Cutlery Insert Wood Organizer					•	•	•	•									236
4DB__WTCO	Four Drawer Bases w/Wood Tiered Cutlery Divider Drawer					•	•	•	•									236
4DB18KCUP	Four Drawer Base w/Wood Tiered K-Cup Drawer					•												237
B__CIW	Bases w/Cutlery Insert Wood Organizer					•	•	•	•									178
B__FHMIJSC	Base Cabinets w/Mixer Shelf						•	•	•									199
B__FHRTLO	Bases w/Lid Organizer & Roll Tray										•	•	•					193
B__FSCO	Base w/Food Storage Container Organizer						•		•									195
B__PS	Pots & Pans Organizer Bases w/Drawer								•		•		•					194
B__RTCIW	Bases w/Cutlery Insert Wood Organizer & Roll Tray					•	•	•	•									191
B__RTLO	Bases w/Drawer & Lid Organizer & Roll Tray										•	•	•					193
B__RTWTCO	Bases w/Wood Tiered Cutlery Divider Drawer & Roll Tray					•	•	•	•									192
B__TDRO	Bases with Roll-out Tray Divider				•	•												198
B__WTCO	Bases w/Wood Tiered Cutlery Divider Drawer					•	•	•	•									178
B18CWP__	Base w/Can and Wine Bottle Pull-outs					•												196
B18HCWP__	Full Height Base w/Can and Wine Bottle Pull-outs					•												197
B18KCUP	Base w/Wood Tiered K-Cup Drawer					•												179
B18KCUPRT	Base w/Wood Tiered K-Cup Drawer and Roll Trays					•												192
BBCPO__OL	Base Box Column Pull-outs (Plain, Overlay)	•	•															244
BBTP24	Base Bin Tray Pull-out								•									239
BBTP24FH	Base Bin Tray Pull-out Full Height								•									240
BBTP24FHFPD	Base Bin Tray Pull-out Full Height w/Pet Feeding Drawer								•									240
BBTP24FPD	Base Bin Tray Pull-out w/Pet Feeding Drawer								•									240
BC__PO	Base Corners w/Pull-out															•	•	216
BCFW__PO	Base Corners Full Width w/Pull-out															•	•	217
BCFW48CPO	Base Corner Full Width w/Curved Pull-out																•	217
BCFW48SP	Base Cabinet Full Width w/Roll Trays & Swing-out																•	218
BCOPP12	Base Container Organizer Pantry Pull-out				•													243
BEAS__	Base Easy Access Storage Cabinets					•	•											183
BMC24	Base Message Center	•																245
BPP__	Base Pantry Pull-outs			•	•													243
BPPP__	Base Pots & Pans Pull-outs								•		•							194
BPT__WB	Base Paper Towel Cabinet w/Wastebasket					•	•											238
BPT__WBFH	Base Paper Towel Cabinet w/Wastebasket Full Height					•	•											239
BRDB36	Base Rotating Deep Bin												•					225
BSC30PR, R, RP, RS, SR	SuperCabinet™										•							184
BSC36PRP, PRS, SRP, SRS	SuperCabinet™												•					186
BSCG__	SuperCabinet™ Gourmet										•		•					185, 187
BUPP__	Base Utensil Pantry Pull-out			•	•													243
BUPPKB__	Base Utensil Pantry Pull-out w/Knife Block			•	•													244
BV2SC30PR, RP, RS, SR	SuperCabinet™ Version 2										•							185
BV2SC36PRP, PRS, SRP, SRS	SuperCabinet™ Version 2												•					187
BWB__	Base Wastebaskets					•	•	•										237
BWB__FH	Base Wastebaskets Full Height					•	•	•										238
CNTYSB__CM	Country Sink Base w/CabMat™										•	•	•					212
LSP36	Lazy Susan Pull-out												•					226

• Available widths

continued

# LOGIX® REFERENCE CHART

84

Base Cabinets, cont'd	Description	3"	6"	9"	12"	15"	18"	21"	24"	27"	30"	33"	36"	39"	42"	45"	48"	Page
SB__CM, SCM, STCM, STSCM	Sink Base w/CabMat™										•	•	•					201, 204, 206, 208
SB__D	Sink Bases w/Drawers Below								•	•	•	•	•	•	•	•	•	209
SB__S	Sink Base SuperCabinet™										•	•	•					206
SB__STS	Sink Base SuperCabinet™ w/Tilt-out Trays										•	•	•					207
SB36CDY	Sink Base w/Caddy												•					201
SB36SCDY	Sink Base SuperCabinet™ w/Caddy												•					207
SB36STCDY	Sink Base w/Tilt-out Trays & Caddy												•					204
SB36STSCDY	Sink Base SuperCabinet™ w/Tilt-out Trays & Caddy												•					208
SLSR__	Super Lazy Susans w/Chrome Rail											•	•					223
SLSR_____	Asymmetrical Super Lazy Susans w/Chrome Rail											•	•					225
SSS36	Segmented Super Lazy Susan												•					222
<b>Tall Cabinets</b>																		
PTU____24	Pantry Top Units					•	•	•	•		•		•					275
PTUP__4924	Pantry Top Units w/Pull-out					•	•											276
PY____24	Pantry Units							•						•				279, 280
TPP____24	Tall Pantry Pull-outs			•	•	•	•											276
UEAS____12, 24	Utility Easy Access					•	•				•		•					268-271
UOC24__6	Utility Organizer Cabinet		•															272
UOCD24__9	Utility Organizer Drop Zone Cabinet								•									273
US21__24	Utility Storage w/Pantry Pull-out							•										278
US21__24PP	Utility Storage w/Pantry Pull-out & Pot and Pan Rack							•										278
<b>Vanity Cabinets</b>																		
LCT88421	Linen Closet							•										341
LCRH188421	Linen Closet w/Removable Hamper							•										342
VBH183421	Vanity Hamper w/Drawer							•										341
VBWB153421	Vanity Base Wastebasket					•												326
VGPO123421	Vanity Grooming Pull-out				•													328
VH183221FH	Vanity Hamper							•										341
VMP__32.5	Vanity Mirror w/Side Pull-outs								•		•							347
VP93421	Vanity Pull-out			•														328
VSB__3421WB	Vanity Sink Bases w/Wastebasket								•		•							319
VSB30__21U	Vanity Sink Bases w/U-Shaped Roll-out Tray										•							319
VSSB__3421ST	Vanity Sink Base SuperCabinet™ w/Tilt-out Trays										•	•	•					320
VSSB__3421STWB	Vanity Sink Base SuperCabinet™ w/Tilt-out Trays and Wastebasket										•	•	•					320
VWB15__21	Vanity Wastebasket Full Height					•												326, 327
VWB15__21RT	Vanity Wastebasket Full Height w/Roll Tray					•												326
VWH__23.521U	Vanity Wall Hung Double Door w/U-Shaped Pull-outs										•		•					344
<b>Modifications</b>																		
CMAT1 (Base, Universal)	CabMat™										•	•	•					48
CMAT2 (Vanity)	CabMat™								•	•	•	•	•					48
DRWTK	Toekick Drawer							•	•	•	•	•	•					55

• Available widths

# Diamond<sup>®</sup>

## DISTINCTION™ SERIES

### WALL CABINET NOMENCLATURE

All Wall Cabinets are 12" deep unless otherwise noted.

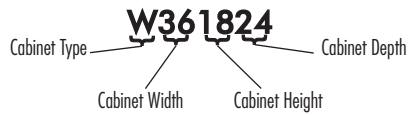

### MODIFICATIONS GRID KEY

- Available
- STD Standard on these cabinets
- L G I X Logix<sup>®</sup> Organization Cabinet



5 Day Express Response Item

CUSTOM MODIFICATIONS			CONSTRUCTION UPGRADES			DOOR OPTIONS	
Mod.	Description	Mod.	Description	Mod.	Description	Mod.	Description
ADDTK*	Add Toekick	EXL	Extended Stile - Left	MIP	Matching Interior Plywood	APC	All-plywood Construction
AUTHL	Authentic End - Left	EXR	Extended Stile - Right	P	Peninsula	PE	Plywood Ends
AUTHR	Authentic End - Right	FB	Finished Ends	PFINBTMB	Prepare Cabinet for Finished Bottom		
CBO	Cabinet Box Only	FFDL	Face Frame and Door on End - Left	RD	Reduced Depth		
CCO	Cabinet Case Only			TD	Tray Dividers		
CFNTO	Cabinet Front Only	FFDR	Face Frame and Door on End - Right	TVRAV	Valance Top Rail, Arch		
CFRMO	Cabinet Frame Only			TVRFV	Valance Top Rail, Furniture		
CND	Cabinet with No Door, with Drawer	FPEB	Furniture Finished Plywood Ends	TVRVV	Valance Top Rail, Straight		
EXBKL	End Extended Back - Left	ID	Increased Depth	WLI	White Laminate Interior		
EXBKR	End Extended Back - Right	INVFRM	Inverted Frame				

\*ADDTK available with compatible toekick modifications.  
See the Modification/Upgrade Compatibility Chart on page 37 for details.

85

### WALL SINGLE DOOR, 12" HIGH

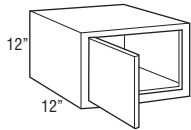

Model	Cubic Feet
W1212 L or R	1.5
W1512 L or R	1.9
W1812 L or R	2.2

#### Custom Modifications

Mod.	Description	Mod.	Description	Mod.	Description	Mod.	Description	Mod.	Description	Mod.	Description	Mod.	Description
ADDTK	AUTHL	CBO	CCO	CFNTO	CFRMO	CND	EXBKL	EXL	FB	FFDL	FPEB		
•	•		•	•	•		•	•	•		•		
							TVRAV						
ID	INVFRM	MIP	P	PFINBTMB	RD	TD	TVRFV					WLI	
•		•	•	•	•		•					•	

#### Construction Upgrades

Mod.	Description
APC	PE
•	•

#### Door Options

Mod.	Description	Mod.	Description	Mod.	Description	Mod.	Description	Mod.	Description
ALF	CG	CG.BTM	CG.TOP	DPSRR	MD	MD.BTM	MD.TOP	MFO	
• <sup>†</sup>	•			•				•	

<sup>†</sup>Not available on 12" wide

**WALL DOUBLE DOOR, 12" HIGH**

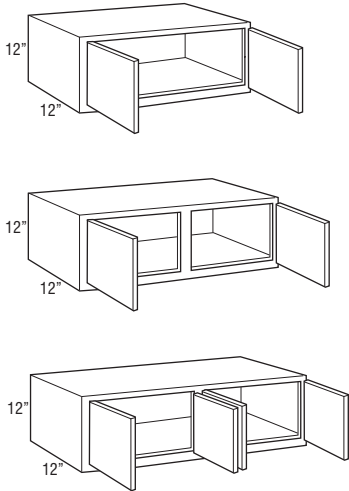

Model	Cubic Feet
W2112	2.6
W2412	3.0
W2712	3.3
W3012	3.7
W3312	4.1
W3412	4.0
W3612	4.4
W3712	4.4
W3912	4.8
W4212	5.1
W4512	5.3
W4812	5.7

• 42" or wider will feature four doors.

**Custom Modifications**

ADDTK	AUTHL AUTHR	CBO	CCO	CFNTO	CFRMO	CND	EXBKL EXBKR	EXL EXR	FB	FFDL FFDR	FPEB
•	•		•	•	•		•	•	•		•
ID	INVERM	MIP	P	PFNBTAB	RD	TD	TBRAV TVRFV TVRVV	WLI			
•		•	•	•	•			•			

**Construction Upgrades**

APC	PE
•	•

**Door Options**

ALF	CG	CG.BTM	CG.TOP	DPSRR	MD	MD.BTM	MD.TOP	MFO
	•			•				•

**WALL TOP HINGE, 12" HIGH**

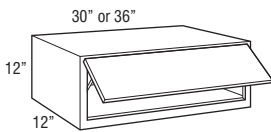

WTH3012	3.7
WTH3612	4.4

- Utilizes doors from 30" and 36" high wall cabinets. Grain on center panels and slab doors will run horizontally and door rail configuration on non-miter doors will be unique from adjacent cabinet doors. Graniti will have standard vertical grain pattern. Tranter will have standard horizontal grain pattern.
- Not available on Liberty.
- When ordered in Arch door styles, door will be Square.
- Art Glass not available.
- Cabinet may utilize one or two lift mechanisms depending on door size and weight. Door lift mechanism tension can be field adjusted.
- Depth can be reduced to a minimum of 9".
- Door will open a maximum of 107° due to hinges. For applications close to a ceiling, door angle can be restricted to 86° with a Hinge Angle Restriction Clip (HINGERESCLIP, see page 429).
- Lift mechanisms and mounting brackets will be visible if used with transparent textured glass.
- Lift mechanism not available for order for field installation, only available factory installed.

**Custom Modifications**

ADDTK	AUTHL AUTHR	CBO	CCO	CFNTO	CFRMO	CND	EXBKL EXBKR	EXL EXR	FB	FFDL FFDR	FPEB
	•		•		•		•	•	•		•
ID	INVERM	MIP	P	PFNBTAB	RD	TD	TBRAV TVRFV TVRVV	WLI			
•		•	•	•	•			•			

**Construction Upgrades**

APC	PE
•	•

**Door Options**

ALF	CG	CG.BTM	CG.TOP	DPSRR	MD	MD.BTM	MD.TOP	MFO
•	•			•				•



**WALL REFRIGERATOR DOUBLE DOOR, 12" HIGH, 24" DEEP**

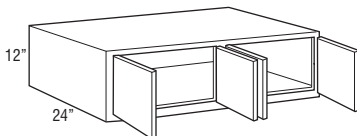
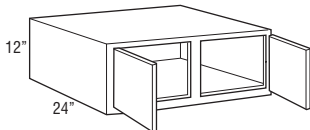
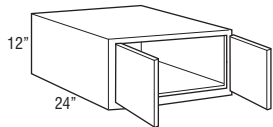

Model	Cubic Feet
<b>W241224</b>	5.5
<b>W271224</b>	5.9
<b>W301224</b>	6.8
<b>W331224</b>	7.4
<b>W341224</b>	7.3
<b>W361224</b>	8.1
<b>W371224</b>	8.0
<b>W391224</b>	8.7
<b>W421224</b>	9.4
<b>W451224</b>	9.9
<b>W481224</b>	10.5

- 24" deep cabinets must be fully supported by screws installed in a structural member in the ceiling or soffit, and into adjacent cabinets.
- Load limit is 15 lbs. per square foot of load bearing surface.
- 42" or wider will feature four doors.

**Custom Modifications**

ADDTK	AUTHL AUTHR	CBO	CCO	CFNTO	CFRMO	CND	EXBKL EXBKR	EXL EXR	FB	FFDL	FPFB
•	•		•	•	•		•	•	•		•
ID	INVERM	MIP	P	PFINBTMB	RD	TD	TVRAV TVRFV TVRVV	WLI			
		•		•	•			•			

**Construction Upgrades**

APC	PE
•	•

**Door Options**

ALF	CG	CG.BTM	CG.TOP	DPSRR	MD	MD.BTM	MD.TOP	MFO
	•			•				•

**WALL TOP HINGE REFRIGERATOR, 12" HIGH, 24" DEEP**

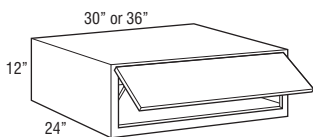

<b>WTH301224</b>	6.8
<b>WTH361224</b>	8.1

- Utilizes doors from 30" and 36" high wall cabinets. Grain on center panels and slab doors will run horizontally and door rail configuration on non-miter doors will be unique from adjacent cabinet doors. Granite will have standard vertical grain pattern. Tranter will have standard horizontal grain pattern.
- Not available on Liberty.
- When ordered in Arch door styles, door will be Square.
- 24" deep cabinets must be fully supported by screws installed in a structural member in the ceiling or soffit, and into adjacent cabinets.
- Load limit is 15 lbs. per square foot of load bearing surface.
- Art Glass not available.
- Cabinet may utilize one or two lift mechanisms depending on door size and weight. Door lift mechanism tension can be field adjusted.
- Depth can be reduced to a minimum of 9".
- Door will open a maximum of 107° due to hinges. For applications close to a ceiling, door angle can be restricted to 86° with a Hinge Angle Restriction Clip (HINGERESCLIP, see page 429).
- Lift mechanisms and mounting brackets will be visible if used with transparent textured glass.
- Lift mechanism not available for order for field installation, only available factory installed.

**Custom Modifications**

ADDTK	AUTHL AUTHR	CBO	CCO	CFNTO	CFRMO	CND	EXBKL EXBKR	EXL EXR	FB	FFDL	FPFB
	•		•		•		•	•	•		•
ID	INVERM	MIP	P	PFINBTMB	RD	TD	TVRAV TVRFV TVRVV	WLI			
		•		•	•			•			

**Construction Upgrades**

APC	PE
•	•

**Door Options**

ALF	CG	CG.BTM	CG.TOP	DPSRR	MD	MD.BTM	MD.TOP	MFO
•	•			•				•

**WALL SINGLE DOOR, 15" HIGH**

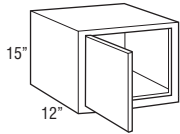

Model	Cubic Feet
W1215 L or R	1.8
W1515 L or R	2.3
W1815 L or R	2.7

**Custom Modifications**

ADDTK	AUTHL AUTHR	CBO	CCO	CFNT0	CFRMO	CND	EXBKL EXBKR	EXL EXR	FB	FFDL FFDR	FPEB
•	•		•	•	•		•	•	•		•
ID	INVFRM	MIP	P	PFNBTAB	RD	TD	TVRV TVRFV TVRVV	WLI			
•		•	•	•	•			•			

**Construction Upgrades**

APC	PE
•	•

**Door Options**

ALF	CG	CG.BTM	CG.TOP	DPSRR	MD	MD.BTM	MD.TOP	MFO
• <sup>†</sup>	•			•				•

<sup>†</sup>Not available on 12" wide

**WALL DOUBLE DOOR, 15" HIGH**

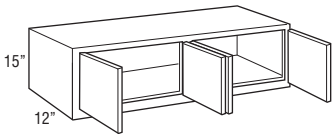
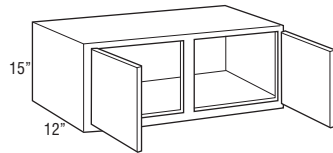
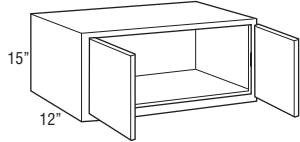

W2115	3.2
W2415	3.6
W2715	4.0
W3015	4.5
W3315	4.9
W3415	4.9
W3615	5.4
W3715	5.3
W3915	5.8
W4215	6.1
W4515	6.5
W4815	6.9

• 42" or wider will feature four doors.

**Custom Modifications**

ADDTK	AUTHL AUTHR	CBO	CCO	CFNT0	CFRMO	CND	EXBKL EXBKR	EXL EXR	FB	FFDL FFDR	FPEB
•	•		•	•	•		•	•	•		•
ID	INVFRM	MIP	P	PFNBTAB	RD	TD	TVRV TVRFV TVRVV	WLI			
•		•	•	•	•			•			

**Construction Upgrades**

APC	PE
•	•

**Door Options**

ALF	CG	CG.BTM	CG.TOP	DPSRR	MD	MD.BTM	MD.TOP	MFO
	•			•				•

### WALL TOP HINGE, 15" HIGH

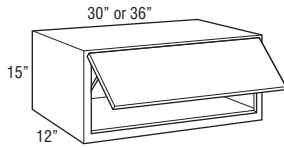

Model	Cubic Feet
WTH3015	4.5
WTH3615	5.4

- Utilizes doors from 30" and 36" high wall cabinets. Grain on center panels and slab doors will run horizontally and door rail configuration on non-miter doors will be unique from adjacent cabinet doors. Granite will have standard vertical grain pattern. Tranter will have standard horizontal grain pattern.
- Not available on Liberty.
- When ordered in Arch door styles, door will be Square.
- Art Glass not available.
- Cabinet may utilize one or two lift mechanisms depending on door size and weight. Door lift mechanism tension can be field adjusted.
- Depth can be reduced to a minimum of 9".
- Door will open a maximum of 107° due to hinges. For applications close to a ceiling, door angle can be restricted to 86° with a Hinge Angle Restriction Clip (HINGERESCLIP, see page 429).
- Lift mechanisms and mounting brackets will be visible if used with transparent textured glass.
- Lift mechanism not available for order for field installation, only available factory installed.

#### Custom Modifications

ADDTK	AUTHL AUTHR	CBO	CCO	CFNTO	CFRMO	CND	EXBKL EXBKR	EXL EXR	FB	FFDL FFDR	FPEB
	•		•		•		•	•			•
ID	INVERM	MIP	P	PFINBTMB	RD	TD	TVRAV TVRFV TVRVV	WLI			
•		•		•	•			•			

#### Construction Upgrades

APC	PE
•	•

#### Door Options

ALF	CG	CG.BTM	CG.TOP	DPSRR	MD	MD.BTM	MD.TOP	MFO
•	•			•				•

### WALL REFRIGERATOR DOUBLE DOOR, 15" HIGH, 24" DEEP

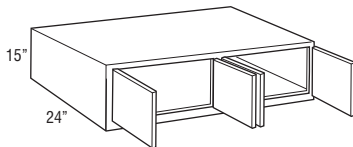
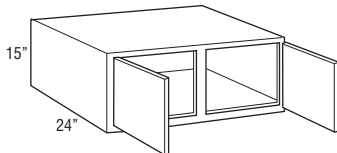
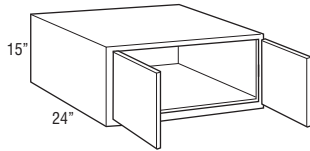

W241524	6.7
W271524	7.2
W301524	8.3
W331524	9.1
W341524	9.0
W361524	9.8
W371524	9.7
W391524	10.6
W421524	11.3
W451524	12.0
W481524	12.8

- 24" deep cabinets must be fully supported by screws installed in a structural member in the ceiling or soffit, and into adjacent cabinets.
- Load limit is 15 lbs. per square foot of load bearing surface.
- 42" or wider will feature four doors.

#### Custom Modifications

ADDTK	AUTHL AUTHR	CBO	CCO	CFNTO	CFRMO	CND	EXBKL EXBKR	EXL EXR	FB	FFDL FFDR	FPEB
•	•		•	•	•		•	•	•		•
ID	INVERM	MIP	P	PFINBTMB	RD	TD	TVRAV TVRFV TVRVV	WLI			
		•		•	•			•			

#### Construction Upgrades

APC	PE
•	•

#### Door Options

ALF	CG	CG.BTM	CG.TOP	DPSRR	MD	MD.BTM	MD.TOP	MFO
	•			•				•

**WALL TOP HINGE REFRIGERATOR,  
15" HIGH, 24" DEEP**

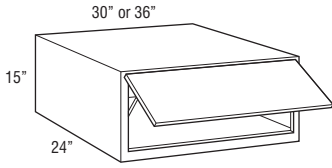

Model	Cubic Feet
WTH301524	8.3
WTH361524	9.8

- Utilizes doors from 30" and 36" high wall cabinets. Grain on center panels and slab doors will run horizontally and door rail configuration on non-miter doors will be unique from adjacent cabinet doors. Granite will have standard vertical grain pattern. Tranter will have standard horizontal grain pattern.
- Not available on Liberty.
- When ordered in Arch door styles, door will be Square.
- 24" deep cabinets must be fully supported by screws installed in a structural member in the ceiling or soffit, and into adjacent cabinets.
- Load limit is 15 lbs. per square foot of load bearing surface.
- Art Glass not available.
- Cabinet may utilize one or two lift mechanisms depending on door size and weight. Door lift mechanism tension can be field adjusted.
- Depth can be reduced to a minimum of 9".
- Door will open a maximum of 107° due to hinges. For applications close to a ceiling, door angle can be restricted to 86° with a Hinge Angle Restriction Clip (HINGERESCLIP, see page 429).
- Lift mechanisms and mounting brackets will be visible if used with transparent textured glass.
- Lift mechanism not available for order for field installation, only available factory installed.

**Custom Modifications**

ADDTK	AUTHL AUTHR	CBO	CCO	CFNTO	CFRMO	CND	EXBKL EXBKR	EXL EXR	FB	FFDL FFDR	FPEB
	•		•		•		•	•	•		•
ID	INVFRM	MIP	P	PFNBTAB	RD	TD	TVRV TVRFV TVRVV	WLI			
		•		•	•			•			

**Construction Upgrades**

APC	PE
•	•

**Door Options**

ALF	CG	CG.BTM	CG.TOP	DPSRR	MD	MD.BTM	MD.TOP	MFO
•	•			•				•

**WALL SINGLE DOOR, 18" HIGH**

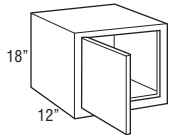

<b>W1218 L or R</b>	<b>2.2</b>
<b>W1518 L or R</b>	<b>2.7</b>
<b>W1818 L or R</b>	<b>3.2</b>
<b>W2118 L or R</b>	<b>3.8</b>
<b>W2418 L or R</b>	<b>4.3</b>

**Custom Modifications**

ADDTK	AUTHL AUTHR	CBO	CCO	CFNTO	CFRMO	CND	EXBKL EXBKR	EXL EXR	FB	FFDL FFDR	FPEB
•	•		•	•	•		•	•	•	•	•
ID	INVFRM	MIP	P	PFNBTAB	RD	TD	TVRV TVRFV TVRVV	WLI			
•		•	•	•	•	•		•			

**Construction Upgrades**

APC	PE
•	•

**Door Options**

ALF	CG	CG.BTM	CG.TOP	DPSRR	MD	MD.BTM	MD.TOP	MFO
	•			•	• <sup>†</sup>			•

<sup>†</sup>Not available on 12", 21", and 24" wide

**WALL DOUBLE DOOR, 18" HIGH**

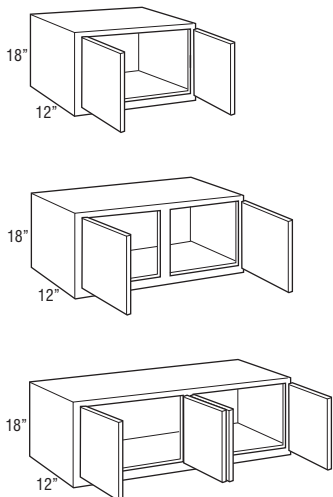

Model	Cubic Feet
W2418	4.3
W2718	4.8
W3018	5.3
W3318	5.4
W3418	5.8
W3618	6.3
W3718	6.3
W3918	6.8
W4218	7.3
W4518	7.6
W4818CS	8.3
W4818	8.3

**Custom Modifications**

	AUTHL AUTHR	CBO	CCO	CFNT0	CFRMO	CND	EXBKL EXBKR	EXL EXR	FB	FFDL FFDR	FPEB
	•		•	•	•		•	•	•	•	•
ID	INVERM	MIP	P	PFINBTMB	RD	TD	TVRAV TVRFV TVRVV	WLI			
•		•	•	•	•	•*		•			

\*Not available on 39", 42", 45", and 48" wide

**Construction Upgrades**

APC	PE
•	•

**Door Options**

ALF	CG	CG.BTM	CG.TOP	DPSRR	MD	MD.BTM	MD.TOP	MFO
	•			•	•†			•

†Available only on 30" and 36" wide

**WALL TOP HINGE, 18" HIGH**

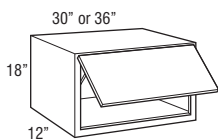

WTH3018	5.3
WTH3618	6.3

- Utilizes doors from 30" and 36" high wall cabinets. Grain on center panels and slab doors will run horizontally and door rail configuration on non-miter doors will be unique from adjacent cabinet doors. Granite will have standard vertical grain pattern. Tranter will have standard horizontal grain pattern.
- Not available on Liberty.
- When ordered in Arch door styles, door will be Square.
- Art Glass not available.
- Cabinet may utilize one or two lift mechanisms depending on door size and weight. Door lift mechanism tension can be field adjusted.
- Depth can be reduced to a minimum of 9".
- Door will open a maximum of 107° due to hinges. For applications close to a ceiling, door angle can be restricted to 86° with a Hinge Angle Restriction Clip (HINGERESCLIP, see page 429).
- Lift mechanisms and mounting brackets will be visible if used with transparent textured glass.
- Lift mechanism not available for order for field installation, only available factory installed.

**Custom Modifications**

	AUTHL AUTHR	CBO	CCO	CFNT0	CFRMO	CND	EXBKL EXBKR	EXL EXR	FB	FFDL FFDR	FPEB
	•		•	•	•		•	•	•	•	•
ID	INVERM	MIP	P	PFINBTMB	RD	TD	TVRAV TVRFV TVRVV	WLI			
•		•	•	•	•	•		•			

**Construction Upgrades**

APC	PE
•	•

**Door Options**

ALF	CG	CG.BTM	CG.TOP	DPSRR	MD	MD.BTM	MD.TOP	MFO
•	•			•				•

**WALL VERTICAL-LIFT, 18" HIGH, 12" DEEP**

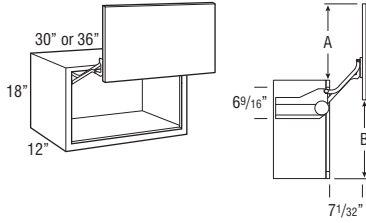

	Full Overlay	Partial Overlay
A	16 13/16"	16 1/16"
B	17 5/16"	18 1/16"

Model	Cubic Feet
WVL3018	5.2
WVL3618	6.1

- Utilizes doors from 30" and 36" high wall cabinets. Grain on center panels and slab doors will run horizontally and door rail configuration on non-miter doors will be unique from adjacent cabinet doors. Granite will have standard vertical grain pattern. Tranter will have standard horizontal grain pattern.
- Decorative hardware required.
- See side view drawing for required clearances.
- Lift mechanism features a single motion for up and out movement with Smart Stop, tension can be field adjusted.
- Lift mechanisms and mounting brackets will be visible if used with transparent textured glass.
- Lift mechanism not available for order for field installation, only available factory installed.
- Hardware extends 1" into opening on each side.
- Art Glass not available.
- Not available on Liberty.
- When ordered in Arch door styles, door will be Square.

**Custom Modifications**

	AUTHL AUTHR	CBO	CCO	CFNTO	CFRMO	CND	EXBKL EXBKR	EXL EXR	FB	FFDL FFDR	FPFB
	•		•		•		•	•	•		•
ID	INVFRM	MIP	P	PFNBTAB	RD	TD	TGRAV TVRFV TVRVV	WLI			
•		•		•				•			

**Construction Upgrades**

APC	PE
•	•

**Door Options**

ALF	CG	CG.BTM	CG.TOP	DPSRR	MD	MD.BTM	MD.TOP	MFO
•	•			•				•

**WALL REFRIGERATOR SINGLE or DOUBLE DOOR, 18" HIGH, 24" DEEP**

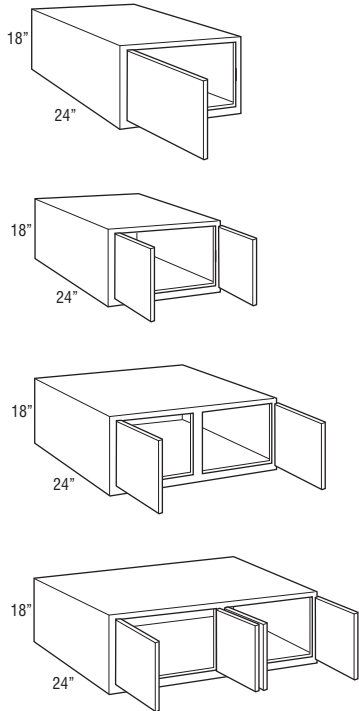

<b>W241824 L or R</b>	7.8
<b>W241824</b>	7.8
<b>W271824</b>	8.5
<b>W301824</b>	9.7
<b>W331824</b>	10.6
<b>W341824</b>	10.6
<b>W361824</b>	11.6
<b>W371824</b>	11.5
<b>W391824</b>	12.6
<b>W421824</b>	13.4
<b>W451824</b>	14.1
<b>W481824CS</b>	15.2
<b>W481824</b>	15.2

- 24" deep cabinets must be fully supported by screws installed in a structural member in the ceiling or soffit, and into adjacent cabinets.
- Load limit is 15 lbs. per square foot of load bearing surface.

**Custom Modifications**

	AUTHL AUTHR	CBO	CCO	CFNTO	CFRMO	CND	EXBKL EXBKR	EXL EXR	FB	FFDL FFDR	FPFB
•	•		•	•	•		•	•	•	•	•
ID	INVFRM	MIP	P	PFNBTAB	RD	TD	TGRAV TVRFV TVRVV	WLI			
		•		•	•	•*		•			

\*Not available on 39", 42", 45", and 48" wide

**Construction Upgrades**

APC	PE
•	•

**Door Options**

ALF	CG	CG.BTM	CG.TOP	DPSRR	MD	MD.BTM	MD.TOP	MFO
	•			•	•†			•

†Available only on 30" and 36" wide

**WALL TOP HINGE REFRIGERATOR,  
18" HIGH, 24" DEEP**

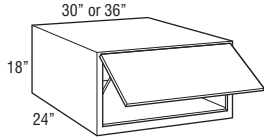

Model	Cubic Feet
WTH301824	9.7
WTH361824	10.6

- Utilizes doors from 30" and 36" high wall cabinets. Grain on center panels and slab doors will run horizontally and door rail configuration on non-miter doors will be unique from adjacent cabinet doors. Granite will have standard vertical grain pattern. Tranter will have standard horizontal grain pattern.
- Not available on Liberty.
- When ordered in Arch door styles, door will be Square.
- 24" deep cabinets must be fully supported by screws installed in a structural member in the ceiling or soffit, and into adjacent cabinets.
- Load limit is 15 lbs. per square foot of load bearing surface.
- Art Glass not available.
- Cabinet may utilize one or two lift mechanisms depending on door size and weight. Door lift mechanism tension can be field adjusted.
- Depth can be reduced to a minimum of 9".
- Door will open a maximum of 107° due to hinges. For applications close to a ceiling, door angle can be restricted to 86° with a Hinge Angle Restriction Clip (HINGERESCLIP, see page 429).
- Lift mechanisms and mounting brackets will be visible if used with transparent textured glass.
- Lift mechanism not available for order for field installation, only available factory installed.

**Custom Modifications**

ADDTK	AUTHL AUTHR	CBO	CCO	CFNT0	CFRMO	CND	EXBKL EXBKR	EXL EXR	FB	FFDL FFDR	FPEB
	•		•		•		•	•	•		•
ID	INVERM	MIP	P	PFINBTMB	RD	TD	TVRAV TVRFV TVRVV	WLI			
		•		•	•	•		•			

**Construction Upgrades**

APC	PE
•	•

**Door Options**

ALF	CG	CG.BTM	CG.TOP	DPSRR	MD	MD.BTM	MD.TOP	MFO
•	•			•				•

**WALL REFRIGERATOR VERTICAL-LIFT,  
18" HIGH, 24" DEEP**

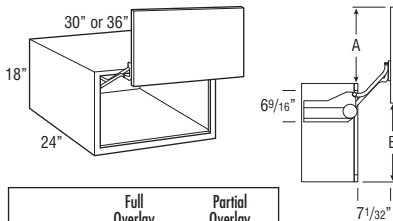

	Full Overlay	Partial Overlay
A	16 13/16"	16 1/16"
B	17 5/16"	18 1/16"

Model	Cubic Feet
WVL301824	9.4
WVL361824	11.2

- Utilizes doors from 30" and 36" high wall cabinets. Grain on center panels and slab doors will run horizontally and door rail configuration on non-miter doors will be unique from adjacent cabinet doors. Granite will have standard vertical grain pattern. Tranter will have standard horizontal grain pattern.
- Decorative hardware required.
- See side view drawing for required clearances.
- Lift mechanism features a single motion for up and out movement with Smart Stop, tension can be field adjusted.
- Lift mechanisms and mounting brackets will be visible if used with transparent textured glass.
- Lift mechanism not available for order for field installation, only available factory installed.
- Hardware extends 1" into opening on each side.
- Art Glass not available.
- Not available on Liberty.
- When ordered in Arch door styles, door will be Square.
- Depth can be reduced to a minimum of 12".

**Custom Modifications**

ADDTK	AUTHL AUTHR	CBO	CCO	CFNT0	CFRMO	CND	EXBKL EXBKR	EXL EXR	FB	FFDL FFDR	FPEB
	•		•		•		•	•	•		•
ID	INVERM	MIP	P	PFINBTMB	RD	TD	TVRAV TVRFV TVRVV	WLI			
		•		•	•			•			

**Construction Upgrades**

APC	PE
•	•

**Door Options**

ALF	CG	CG.BTM	CG.TOP	DPSRR	MD	MD.BTM	MD.TOP	MFO
•	•			•				•

**WALL REFRIGERATOR PULL-OUT,  
18" HIGH, 24" DEEP**

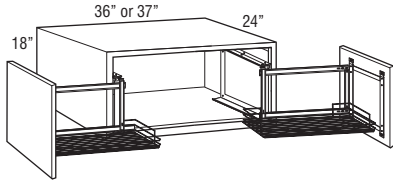

W361824PO L or R  
W371824PO L or R  
W361824PO  
W371824PO

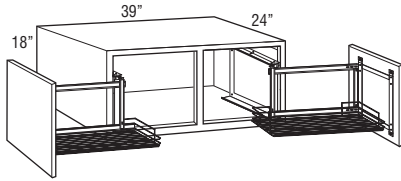

W391824PO L or R  
W391824PO

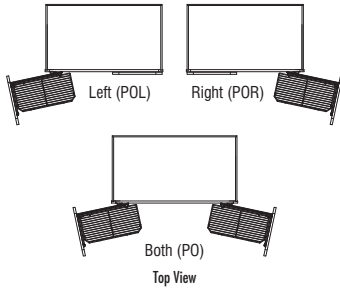

Model	Cubic Feet
W361824PO L or R	11.2
W371824PO L or R	11.5
W361824PO	11.2
W371824PO	11.5
W391824PO L or R	12.6
W391824PO	12.6

- Door-mounted pull-out with a chrome wire rack that extends fully to the front of the cabinet then opens to the side for easy accessibility to contents. Designed for use above refrigerators or other high applications. Smart Stop not included.
- Available installed in either the left side, right side, or both sides.
- For sufficient pull-out clearance, 13 1/8" of adjacent space is required for door to open fully when installed near a wall or corner.
- Chrome rack is 10" wide and 20 13/16" deep.
- 24" deep cabinets must be fully supported by screws installed in a structural member in the ceiling or soffit, and into adjacent cabinets.
- Load limit is 15 lbs. per square foot of load bearing surface.

**Custom Modifications**

ADDTK	AUTHL AUTHR	CBO	CCO	CFNTO	CFRMO	CND	EXBKL EXBKR	EXL EXR	FB	FFDL FFDR	FPEB
•	•	•			•		•	•	•		•
ID	INVFRM	MIP	P	PFINBTMB	RD	TD	TAVRAV TVRFV TVRVV	WLI			
		•		•				•			

**Construction Upgrades**

APC	PE
•	•

**Door Options**

ALF	CG	CG.BTM	CG.TOP	DPSRR	MD	MD.BTM	MD.TOP	MFO
				•				•

**WALL SINGLE DOOR, 21" HIGH**

12", 15", 18", 21", or 24"

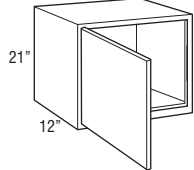

W1221 L or R	2.7
W1521 L or R	3.3
W1821 L or R	3.8
W2121 L or R	4.4
W2421 L or R	5.0

**Custom Modifications**

ADDTK	AUTHL AUTHR	CBO	CCO	CFNTO	CFRMO	CND	EXBKL EXBKR	EXL EXR	FB	FFDL FFDR	FPEB
•	•		•	•	•		•	•	•	•	•
ID	INVFRM	MIP	P	PFINBTMB	RD	TD	TAVRAV TVRFV TVRVV	WLI			
•		•	•	•	•	•		•			

**Construction Upgrades**

APC	PE
•	•

**Door Options**

ALF	CG	CG.BTM	CG.TOP	DPSRR	MD	MD.BTM	MD.TOP	MFO
	•			•				•



**WALL DOUBLE DOOR, 21" HIGH**

24", 27", 30", 33", 34", 36", or 37"

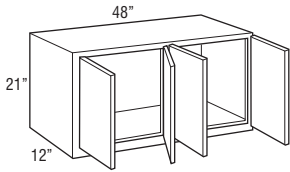
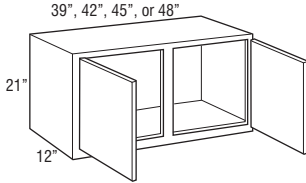
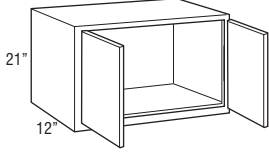

Model	Cubic Feet
<b>W2421</b>	5.0
<b>W2721</b>	5.6
<b>W3021</b>	5.6
<b>W3321</b>	6.7
<b>W3421</b>	6.7
<b>W3621</b>	7.2
<b>W3721</b>	7.3
<b>W3921</b> 7.8	
<b>W4221</b> 8.5	
<b>W4521</b> 8.8	
<b>W4821CS</b> 9.7	
<b>W4821</b> 9.7	

**Custom Modifications**

	AUTHL AUTHR	CBO	CCO	CFNTO	CFRMO	CND	EXBKL EXBKR	EXL EXR	FB	FFDL	FPEB
	•		•	•	•		•	•	•	•	•
ID	INVERM	MIP	P	PFINBTMB	RD	TD	TVRAV TVRFV TVRVV	WLI			
•		•	•	•	•	•*		•			

\*Not available on 39", 42", 45", and 48" wide

**Construction Upgrades**

APC	PE
•	•

**Door Options**

ALF	CG	CG.BTM	CG.TOP	DPSRR	MD	MD.BTM	MD.TOP	MFO
	•			•				•

**WALL TOP HINGE, 21" HIGH**

30" or 36"

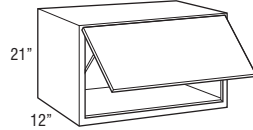

<b>WTH3021</b>	5.6
<b>WTH3621</b>	7.2

- Utilizes doors from 30" and 36" high wall cabinets. Grain on center panels and slab doors will run horizontally and door rail configuration on non-miter doors will be unique from adjacent cabinet doors. Granite will have standard vertical grain pattern. Tranter will have standard horizontal grain pattern.
- Not available on Liberty.
- When ordered in Arch door styles, door will be Square.
- Art Glass not available.
- Cabinet may utilize one or two lift mechanisms depending on door size and weight. Door lift mechanism tension can be field adjusted.
- Depth can be reduced to a minimum of 9".
- Door will open a maximum of 107° due to hinges. For applications close to a ceiling, door angle can be restricted to 86° with a Hinge Angle Restriction Clip (HINGERESCLIP, see page 429).
- Lift mechanisms and mounting brackets will be visible if used with transparent textured glass.
- Lift mechanism not available for order for field installation, only available factory installed.

**Custom Modifications**

	AUTHL AUTHR	CBO	CCO	CFNTO	CFRMO	CND	EXBKL EXBKR	EXL EXR	FB	FFDL	FPEB
	•		•		•		•	•	•		•
ID	INVERM	MIP	P	PFINBTMB	RD	TD	TVRAV TVRFV TVRVV	WLI			
•		•		•	•	•		•			

**Construction Upgrades**

APC	PE
•	•

**Door Options**

ALF	CG	CG.BTM	CG.TOP	DPSRR	MD	MD.BTM	MD.TOP	MFO
•	•			•				•

**WALL VERTICAL-LIFT, 21" HIGH, 12" DEEP**

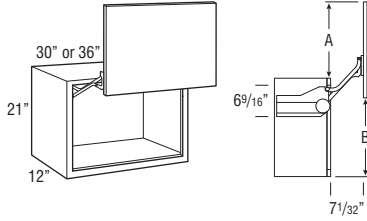

	Full Overlay	Partial Overlay
A	16 13/16"	16 1/16"
B	17 5/16"	18 1/16"

Model	Cubic Feet
WVL3021	5.9
WVL3621	7.1

- Utilizes doors from 30" and 36" high wall cabinets. Grain on center panels and slab doors will run horizontally and door rail configuration on non-miter doors will be unique from adjacent cabinet doors. Granite will have standard vertical grain pattern. Tranter will have standard horizontal grain pattern.
- Decorative hardware required.
- See side view drawing for required clearances.
- Lift mechanism features a single motion for up and out movement with Smart Stop, tension can be field adjusted.
- Lift mechanisms and mounting brackets will be visible if used with transparent textured glass.
- Lift mechanism not available for order for field installation, only available factory installed.
- Hardware extends 1" into opening on each side.
- Art Glass not available.
- Not available on Liberty.
- When ordered in Arch door styles, door will be Square.

**Custom Modifications**

ADDTK	AUTHL AUTHR	CBO	CCO	CFNTO	CFRMO	CND	EXBKL EXBKR	EXL EXR	FB	FFDL FFDR	FPEB
•	•		•		•		•	•	•		•
ID	INVFRM	MIP	P	PFNBTAB	RD	TD	TAVR TVRFV TVRVV	WLI			
•		•		•				•			

**Construction Upgrades**

APC	PE
•	•

**Door Options**

ALF	CG	CG.BTM	CG.TOP	DPSRR	MD	MD.BTM	MD.TOP	MFO
•	•			•				•

**WALL REFRIGERATOR SINGLE or DOUBLE DOOR, 21" HIGH, 24" DEEP**

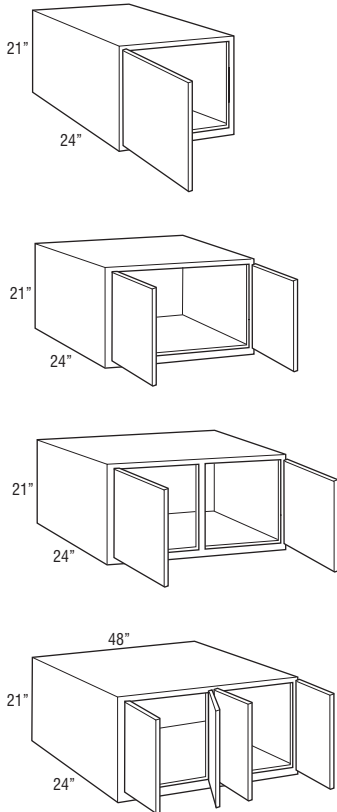

<b>W242124 L or R</b>	9.0
<b>W242124</b>	9.0
<b>W272124</b>	9.8
<b>W302124</b>	11.1
<b>W332124</b>	12.2
<b>W342124</b>	12.2
<b>W362124</b>	13.3
<b>W372124</b>	13.3
<b>W392124</b>	14.3
<b>W422124</b>	15.2
<b>W452124</b>	16.3
<b>W482124CS</b>	17.3
<b>W482124</b>	17.3

- 24" deep cabinets must be fully supported by screws installed in a structural member in the ceiling or soffit, and into adjacent cabinets.
- Load limit is 15 lbs. per square foot of load bearing surface.

**Custom Modifications**

ADDTK	AUTHL AUTHR	CBO	CCO	CFNTO	CFRMO	CND	EXBKL EXBKR	EXL EXR	FB	FFDL FFDR	FPEB
•	•		•	•	•		•	•	•	•	•
ID	INVFRM	MIP	P	PFNBTAB	RD	TD	TAVR TVRFV TVRVV	WLI			
		•		•	•	•*		•			

\*Not available on 39", 42", 45", and 48" wide

**Construction Upgrades**

APC	PE
•	•

**Door Options**

ALF	CG	CG.BTM	CG.TOP	DPSRR	MD	MD.BTM	MD.TOP	MFO
	•			•				•

**WALL TOP HINGE REFRIGERATOR,  
21" HIGH, 24" DEEP**

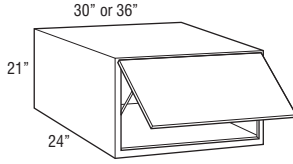

Model	Cubic Feet
WTH302124	11.1
WTH362124	13.3

- Utilizes doors from 30" and 36" high wall cabinets. Grain on center panels and slab doors will run horizontally and door rail configuration on non-miter doors will be unique from adjacent cabinet doors. Graniti will have standard vertical grain pattern. Tranter will have standard horizontal grain pattern.
- Not available on Liberty.
- When ordered in Arch door styles, door will be Square.
- 24" deep cabinets must be fully supported by screws installed in a structural member in the ceiling or soffit, and into adjacent cabinets.
- Load limit is 15 lbs. per square foot of load bearing surface.
- Art Glass not available.
- Cabinet may utilize one or two lift mechanisms depending on door size and weight. Door lift mechanism tension can be field adjusted.
- Depth can be reduced to a minimum of 9".
- Door will open a maximum of 107° due to hinges. For applications close to a ceiling, door angle can be restricted to 86° with a Hinge Angle Restriction Clip (HINGERESCLIP, see page 429).
- Lift mechanisms and mounting brackets will be visible if used with transparent textured glass.
- Lift mechanism not available for order for field installation, only available factory installed.

**Custom Modifications**

ADDTK	AUTHL AUTHR	CBO	CCO	CFNTO	CFRMO	CND	EXBKL EXBKR	EXL EXR	FB	FFDL FFDR	FPFB
	•		•		•		•	•	•		•
ID	INVERM	MIP	P	PFINBTMB	RD	TD	TVRAV TVRFV TVRVV	WLI			
		•		•	•	•		•			

**Construction Upgrades**

APC	PE
•	•

**Door Options**

ALF	CG	CG.BTM	CG.TOP	DPSRR	MD	MD.BTM	MD.TOP	MFO
•	•			•				•

**WALL REFRIGERATOR VERTICAL-LIFT,  
21" HIGH, 24" DEEP**

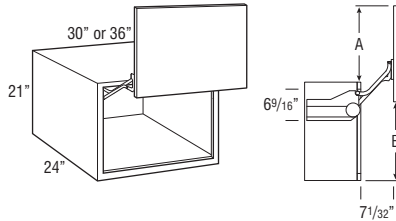

	Full Overlay	Partial Overlay
A	16 13/16"	16 1/16"
B	17 5/16"	18 1/16"

Model	Cubic Feet
WVL302124	10.9
WVL362124	12.9

- Utilizes doors from 30" and 36" high wall cabinets. Grain on center panels and slab doors will run horizontally and door rail configuration on non-miter doors will be unique from adjacent cabinet doors. Graniti will have standard vertical grain pattern. Tranter will have standard horizontal grain pattern.
- Decorative hardware required.
- See side view drawing for required clearances.
- Lift mechanism features a single motion for up and out movement with Smart Stop, tension can be field adjusted.
- Lift mechanisms and mounting brackets will be visible if used with transparent textured glass.
- Lift mechanism not available for order for field installation, only available factory installed.
- Hardware extends 1" into opening on each side.
- Art Glass not available.
- Not available on Liberty.
- When ordered in Arch door styles, door will be Square.
- Depth can be reduced to a minimum of 12".

**Custom Modifications**

ADDTK	AUTHL AUTHR	CBO	CCO	CFNTO	CFRMO	CND	EXBKL EXBKR	EXL EXR	FB	FFDL FFDR	FPFB
	•		•		•		•	•	•		•
ID	INVERM	MIP	P	PFINBTMB	RD	TD	TVRAV TVRFV TVRVV	WLI			
•		•		•	•			•			

**Construction Upgrades**

APC	PE
•	•

**Door Options**

ALF	CG	CG.BTM	CG.TOP	DPSRR	MD	MD.BTM	MD.TOP	MFO
•	•			•				•

**WALL REFRIGERATOR PULL-OUT,  
21" HIGH, 24" DEEP**

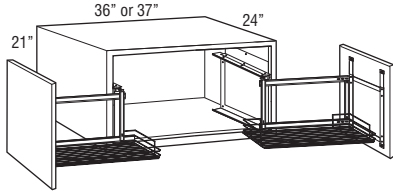

W362124PO L or R  
W372124PO L or R  
W362124PO  
W372124PO

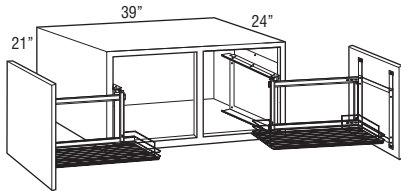

W392124PO L or R  
W392124PO

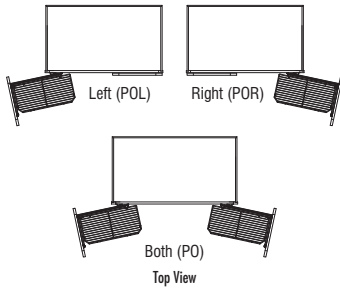

Model	Cubic Feet
W362124PO L or R	13.3
W372124PO L or R	13.3
W362124PO	13.3
W372124PO	13.3
W392124PO L or R	14.3
W392124PO	14.3

- Door-mounted pull-out with a chrome wire rack that extends fully to the front of the cabinet then opens to the side for easy accessibility to contents. Designed for use above refrigerators or other high applications. Smart Stop not included.
- Available installed in either the left side, right side, or both sides.
- For sufficient pull-out clearance, 13 1/8" of adjacent space is required for door to open fully when installed near a wall or corner.
- Chrome rack is 10" wide and 20 13/16" deep.
- 24" deep cabinets must be fully supported by screws installed in a structural member in the ceiling or soffit, and into adjacent cabinets.
- Load limit is 15 lbs. per square foot of load bearing surface.

**Custom Modifications**

ADDTK	AUTHL AUTHR	CBO	CCO	CFNT0	CFRMO	CND	EXBKL EXBKR	EXL EXR	FB	FFDL FFDR	FPFB
•	•		•		•		•	•	•		•
ID	INVFRM	MIP	P	PFINBTMB	RD	TD	TVRAV TVRFV TVRVV	WLI			
		•		•				•			

**Construction Upgrades**

APC	PE
•	•

**Door Options**

ALF	CG	CG.BTM	CG.TOP	DPSRR	MD	MD.BTM	MD.TOP	MFO
				•				•

**WALL SINGLE DOOR, 24" HIGH**

12", 15", 18", 21", or 24"

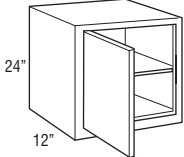

W1224 L or R	3.0
W1524 L or R	3.6
W1824 L or R	4.2
W2124 L or R	4.3
W2424 L or R	5.5

**Custom Modifications**

ADDTK	AUTHL AUTHR	CBO	CCO	CFNT0	CFRMO	CND	EXBKL EXBKR	EXL EXR	FB	FFDL FFDR	FPFB
•	•	•	•	•	•		•	•	•	•	•
ID	INVFRM	MIP	P	PFINBTMB	RD	TD	TVRAV TVRFV TVRVV	WLI			
•		•	•	•	•	•		•			

**Construction Upgrades**

APC	PE
•	•

**Door Options**

ALF	CG	CG.BTM	CG.TOP	DPSRR	MD	MD.BTM	MD.TOP	MFO
	•			•				•

**WALL DOUBLE DOOR, 24" HIGH**

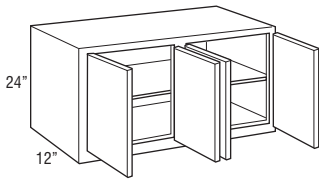
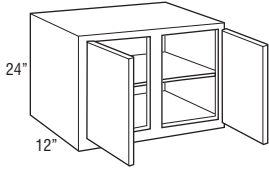
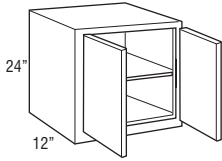

Model	Cubic Feet
W2424	5.5
W2724	6.1
W3024	6.8
W3324	7.4
W3424	7.6
W3624	8.0
W3724	8.2
W3924	8.6
W4224	9.3
W4524	9.9
W4824CS	10.5
W4824	10.5

**Custom Modifications**

ADDTK	AUTHL AUTHR	CBO	CCO	CFNTD	CFRMO	CND	EXBKL EXBKR	EXL EXR	FB	FFDL FFDR	FPEB
•	•	•	•	•	•		•	•	•	•	•
ID	INVERM	MIP	P	PFINBTMB	RD	TD	TVRAV TVRFV TVRVV	WLI			
•		•	•	•	•	•*		•			

\*Not available on 39", 42", 45", and 48" wide

**Construction Upgrades**

APC	PE
•	•

**Door Options**

ALF	CG	CG.BTM	CG.TOP	DPSRR	MD	MD.BTM	MD.TOP	MFO
	•			•	•†			•

†Available only on 30" and 36" wide

**WALL REFRIGERATOR SINGLE or DOUBLE DOOR, 24" HIGH, 24" DEEP**

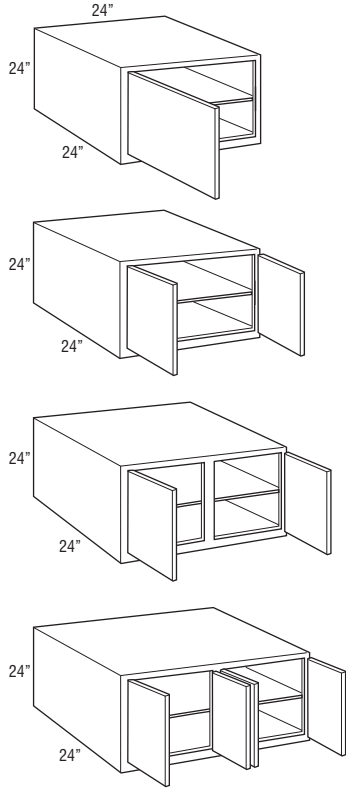

Model	Cubic Feet
<b>W242424 L or R</b>	10.5
<b>W242424</b>	10.5
<b>W272424</b>	10.9
<b>W302424</b>	12.4
<b>W332424</b>	13.6
<b>W342424</b>	13.9
<b>W362424</b>	14.7
<b>W372424</b>	15.1
<b>W392424</b>	15.9
<b>W422424</b>	17.1
<b>W452424</b>	18.4
<b>W482424CS</b>	19.6
<b>W482424</b>	19.6

- 24" deep cabinets must be fully supported by screws installed in a structural member in the ceiling or soffit, and into adjacent cabinets.
- Load limit is 15 lbs. per square foot of load bearing surface.

**Custom Modifications**

	ADDTK	AUTHL AUTHR	CBO	CCO	CFNTO	CFRMO	CND	EXBKL EXBKR	EXL EXR	FB	FFDL FFDR	FPEB
	•	•	•	•	•	•		•	•	•	•	•
ID	INVERM	MIP	P	PFINBTMB	RD	TD		TVRAV TVRFV TVRVV	WLI			
		•		•	•	•*			•			

\*Not available on 39", 42", 45", and 48" wide

**Construction Upgrades**

APC	PE
•	•

**Door Options**

ALF	CG	CG.BTM	CG.TOP	DPSRR	MD	MD.BTM	MD.TOP	MFO
	•			•	•†			•

†Available only on 30" and 36" wide

**WALL REFRIGERATOR PULL-OUT,  
24" HIGH, 24" DEEP**

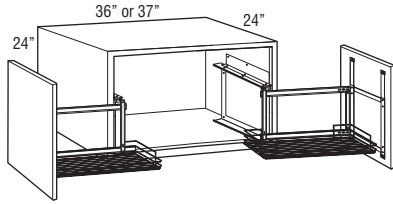

W362424PO L or R  
W372424PO L or R  
W362424PO  
W372424PO

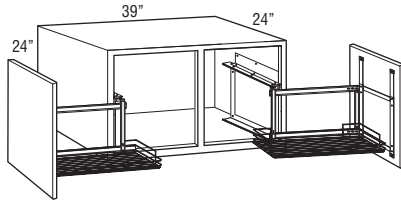

W392424PO L or R  
W392424PO

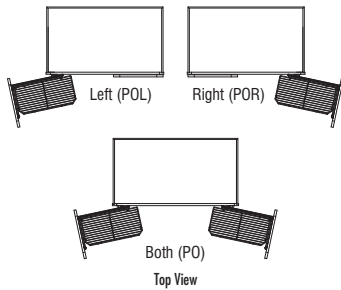

Model	Cubic Feet
W362424PO L or R	14.7
W372424PO L or R	15.1
W362424PO	14.7
W372424PO	15.1
W392424PO L or R	15.9
W392424PO	15.9

- Door-mounted pull-out with a chrome wire rack that extends fully to the front of the cabinet then opens to the side for easy accessibility to contents. Designed for use above refrigerators or other high applications. Smart Stop not included.
- Available installed in either the left side, right side, or both sides.
- For sufficient pull-out clearance, 13 1/8" of adjacent space is required for door to open fully when installed near a wall or corner.
- Chrome rack is 10" wide and 20 13/16" deep.
- 24" deep cabinets must be fully supported by screws installed in a structural member in the ceiling or soffit, and into adjacent cabinets.
- Load limit is 15 lbs. per square foot of load bearing surface.

**Custom Modifications**

ADDTK	AUTHL AUTHR	CBO	CCO	CFNTO	CFRMO	CND	EXBKL EXBKR	EXL EXR	FB	FFDL FFDR	FPFB
•	•		•		•		•	•	•		•
ID	INVERM	MIP	P	PFINBTMB	RD	TD	TVRAV TVRFV TVRVV	WLI			
		•		•				•			

**Construction Upgrades**

APC	PE
•	•

**Door Options**

ALF	CG	CG.BTM	CG.TOP	DPSRR	MD	MD.BTM	MD.TOP	MFO
				•				•

**WALL SINGLE DOOR, 27" HIGH**

12", 15", 18", 21", or 24"

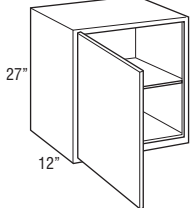

W1227 L or R	3.4
W1527 L or R	4.1
W1827 L or R	4.9
W2127 L or R	5.6
W2427 L or R	6.3

**Custom Modifications**

ADDTK	AUTHL AUTHR	CBO	CCO	CFNTO	CFRMO	CND	EXBKL EXBKR	EXL EXR	FB	FFDL FFDR	FPFB
•	•	•	•	•	•		•	•	•	•	•
ID	INVERM	MIP	P	PFINBTMB	RD	TD	TVRAV TVRFV TVRVV	WLI			
•		•	•	•	•	•		•			

**Construction Upgrades**

APC	PE
•	•

**Door Options**

ALF	CG	CG.BTM	CG.TOP	DPSRR	MD	MD.BTM	MD.TOP	MFO
	•			•				•

**WALL DOUBLE DOOR, 27" HIGH**

24", 27", 30", 33", 34", 36", or 37"

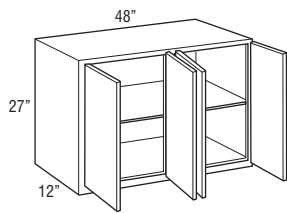
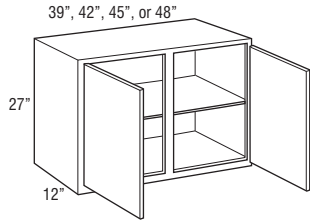
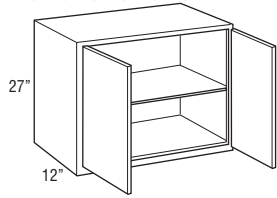

Model	Cubic Feet
<b>W2427</b>	6.3
<b>W2727</b>	7.1
<b>W3027</b>	7.8
<b>W3327</b>	8.5
<b>W3427</b>	8.5
<b>W3627</b>	9.3
<b>W3727</b>	9.2
<b>W3927</b>	10.0
<b>W4227</b>	10.7
<b>W4527</b>	11.0
<b>W4827CS</b>	12.2
<b>W4827</b>	12.2

**Custom Modifications**

	AUTHL AUTHR	CBO	CCO	CFNTO	CFRMO	CND	EXBKL EXBKR	EXL EXR	FB	FFDL FFDR	FPEB
	•	•	•	•	•		•	•	•	•	•
ID	INVFRM	MIP	P	PFNBMTB	RD	TD	TVRAV TVRFV TVRVV	WLI			
•		•	•	•	•	•*		•			

\*Not available on 39", 42", 45", and 48" wide

**Construction Upgrades**

APC	PE
•	•

**Door Options**

ALF	CG	CG.BTM	CG.TOP	DPSRR	MD	MD.BTM	MD.TOP	MFO
	•			•				•



**WALL REFRIGERATOR SINGLE or DOUBLE DOOR, 27" HIGH, 24" DEEP**

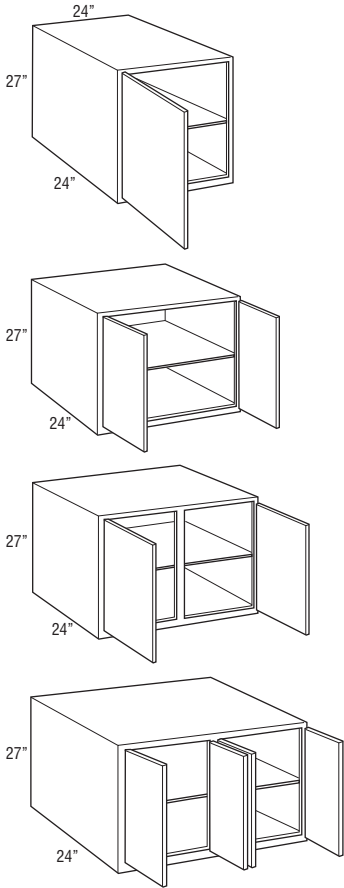

Model	Cubic Feet
<b>W242724 L or R</b>	11.3
<b>W242724</b>	11.3
<b>W272724</b>	12.7
<b>W302724</b>	14.4
<b>W332724</b>	15.7
<b>W342724</b>	15.5
<b>W362724</b>	17.0
<b>W372724</b>	16.8
<b>W392724</b>	18.4
<b>W422724</b>	19.2
<b>W452724</b>	21.3
<b>W482724CS</b>	22.6
<b>W482724</b>	22.6

- 24" deep cabinets must be fully supported by screws installed in a structural member in the ceiling or soffit, and into adjacent cabinets.
- Load limit is 15 lbs. per square foot of load bearing surface.

**Custom Modifications**

ADDTK	AUTHL AUTHR	CBO	CCO	CFNT0	CFRMO	CND	EXBKL EXBKR	EXL EXR	FB	FFDL FFDR	FPEB
•	•	•	•	•	•		•	•	•	•	•
ID	INVFRM	MIP	P	PFINBTMB	RD	TD	TVRAV TVRFV TVRVV	WLI			
•		•	•	•	•	•*		•			

\*Not available on 39", 42", 45", and 48" wide

**Construction Upgrades**

APC	PE
•	•

**Door Options**

ALF	CG	CG.BTM	CG.TOP	DPSRR	MD	MD.BTM	MD.TOP	MFO
•	•			•				•

**WALL SINGLE DOOR, 30" HIGH**

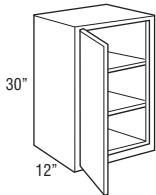

<b>W930 L or R</b>	2.9
<b>W1230 L or R</b>	3.7
<b>W1530 L or R</b>	4.5
<b>W1830 L or R</b>	5.3
<b>W2130 L or R</b>	6.1
<b>W2430 L or R</b>	6.9

**Custom Modifications**

ADDTK	AUTHL AUTHR	CBO	CCO	CFNT0	CFRMO	CND	EXBKL EXBKR	EXL EXR	FB	FFDL FFDR	FPEB
•	•	•	•	•	•		•	•	•	•	•
ID	INVFRM	MIP	P	PFINBTMB	RD	TD	TVRAV TVRFV TVRVV	WLI			
•		•	•	•	•	•		•			

**Construction Upgrades**

APC	PE
•	•

**Door Options**

ALF	CG	CG.BTM	CG.TOP	DPSRR	MD	MD.BTM	MD.TOP	MFO
• <sup>†</sup>	•			•	• <sup>‡</sup>			•

<sup>†</sup>Not available on 9" and 24" wide

<sup>‡</sup>Not available on 9" and 12" wide

**WALL DOUBLE DOOR, 30" HIGH**

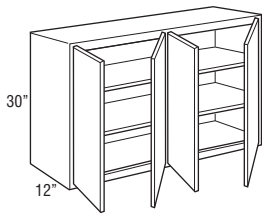
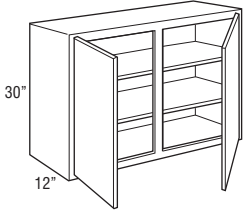
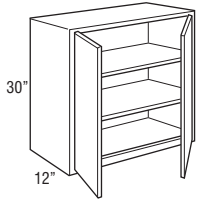

Model	Cubic Feet
<b>W2430</b>	6.9
<b>W2730</b>	7.7
<b>W3030</b>	8.5
<b>W3330</b>	9.3
<b>W3630</b>	10.0
<b>W3930</b>	10.8
<b>W4230</b>	11.6
<b>W4530</b>	12.2
<b>W4830CS</b>	13.2
<b>W4830</b>	13.2

**Custom Modifications**

ADDTK	AUTHL AUTHR	CBO	CCO	CFNTO	CFRMO	CND	EXBKL EXBKR	EXL EXR	FB	FFDL FFDR	FPEB
•	•	•	•	•	•		•	•	•	•	•
ID	INVFRM	MIP	P	PFNBMTB	RD	TD	TVRAV TVRFV TVRVV	WLI			
•		•	•	•	•	•*		•			

\*Not available on 39", 42", 45", and 48" wide

**Construction Upgrades**

APC	PE
•	•

**Door Options**

ALF	CG	CG.BTM	CG.TOP	DPSRR	MD	MD.BTM	MD.TOP	MFO
	•			•	•†			•

†Not available on 39" wide

**WALL SINGLE DOOR, 33" HIGH**

9", 12", 15", 18", 21", or 24"

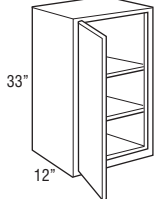

<b>W933 L or R</b>	3.2
<b>W1233 L or R</b>	4.1
<b>W1533 L or R</b>	5.0
<b>W1833 L or R</b>	5.9
<b>W2133 L or R</b>	6.7
<b>W2433 L or R</b>	7.6

**Custom Modifications**

ADDTK	AUTHL AUTHR	CBO	CCO	CFNTO	CFRMO	CND	EXBKL EXBKR	EXL EXR	FB	FFDL FFDR	FPEB
•	•	•	•	•	•		•	•	•	•	•
ID	INVFRM	MIP	P	PFNBMTB	RD	TD	TVRAV TVRFV TVRVV	WLI			
•		•	•	•	•			•			

**Construction Upgrades**

APC	PE
•	•

**Door Options**

ALF	CG	CG.BTM	CG.TOP	DPSRR	MD	MD.BTM	MD.TOP	MFO
	•			•	•†			•

†Not available on 9" and 12" wide

**WALL DOUBLE DOOR, 33" HIGH**

24", 27", 30", 33", or 36"

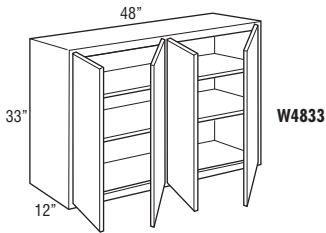
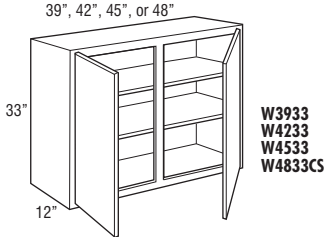
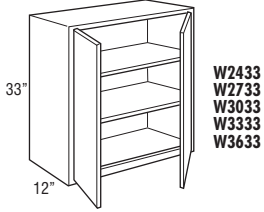

Model	Cubic Feet
W2433	7.6
W2733	8.5
W3033	9.4
W3333	10.3
W3633	11.2
W3933	12.1
W4233	13.0
W4533	13.3
W4833CS	14.8
W4833	14.8

**Custom Modifications**

ADDTK	AUTHL AUTHR	CBO	CCO	CFNTO	CFRMO	CND	EXBKL EXBKR	EXL EXR	FB	FFDL FFDR	FPEB
•	•	•	•	•	•		•	•	•	•	•
ID	INVERM	MIP	P	PFINBTMB	RD	TD	TVRAV TVRFV TVRVV	WLI			
•		•	•	•	•			•			

**Construction Upgrades**

APC	PE
•	•

**Door Options**

ALF	CG	CG.BTM	CG.TOP	DPSRR	MD	MD.BTM	MD.TOP	MFO
	•			•	• <sup>†</sup>			•

<sup>†</sup>Not available on 39" wide

**WALL SINGLE DOOR, 36" HIGH**

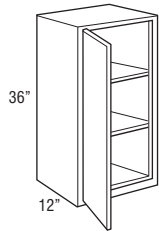

W936 L or R	3.5
W1236 L or R	4.4
W1536 L or R	5.3
W1836 L or R	6.3
W2136 L or R	7.2
W2436 L or R	8.2

**Custom Modifications**

ADDTK	AUTHL AUTHR	CBO	CCO	CFNTO	CFRMO	CND	EXBKL EXBKR	EXL EXR	FB	FFDL FFDR	FPEB
•	•	•	•	•	•		•	•	•	•	•
ID	INVERM	MIP	P	PFINBTMB	RD	TD	TVRAV TVRFV TVRVV	WLI			
•		•	•	•	•			•			

**Construction Upgrades**

APC	PE
•	•

**Door Options**

ALF	CG	CG.BTM	CG.TOP	DPSRR	MD	MD.BTM	MD.TOP	MFO
• <sup>†</sup>	•			•	• <sup>‡</sup>			•

<sup>†</sup>Not available on 9" and 24" wide

<sup>‡</sup>Not available on 9" and 12" wide

**WALL DOUBLE DOOR, 36" HIGH**

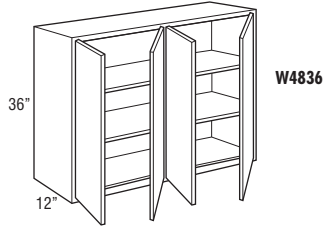
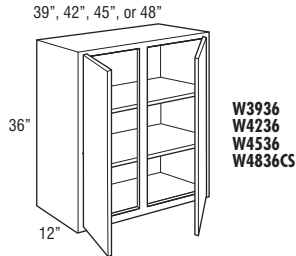
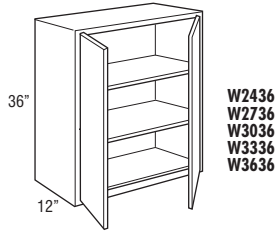

Model	Cubic Feet
W2436	8.2
W2736	9.1
W3036	10.0
W3336	11.0
W3636	11.8
W3936	11.8
W4236	13.8
W4536	14.5
W4836CS	14.5
W4836	14.5

**Custom Modifications**

ADDTK	AUTHL AUTHR	CBO	CCO	CFNTO	CFRMO	CND	EXBKL EXBKR	EXL EXR	FB	FFDL FFDR	FPFB
•	•	•	•	•	•		•	•	•	•	•
ID	INVFRM	MIP	P	PFNBMTB	RD	TD	TVRAV TVRFV TVRVV	WLI			
•		•	•	•	•			•			

**Construction Upgrades**

APC	PE
•	•

**Door Options**

ALF	CG	CG.BTM	CG.TOP	DPSRR	MD	MD.BTM	MD.TOP	MFO
	•			•	• <sup>†</sup>			•

<sup>†</sup>Not available on 39" wide

**WALL SINGLE DOOR, 39" HIGH**

9", 12", 15", 18", 21" or 24"

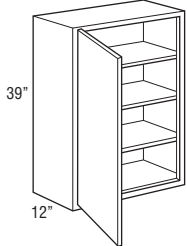

W939 L or R	3.7
W1239 L or R	4.7
W1539 L or R	5.7
W1839 L or R	6.8
W2139 L or R	7.8
W2439 L or R	8.8

**Custom Modifications**

ADDTK	AUTHL AUTHR	CBO	CCO	CFNTO	CFRMO	CND	EXBKL EXBKR	EXL EXR	FB	FFDL FFDR	FPFB
•	•	•	•	•	•		•	•	•	•	•
ID	INVFRM	MIP	P	PFNBMTB	RD	TD	TVRAV TVRFV TVRVV	WLI			
•		•	•	•	•			•			

**Construction Upgrades**

APC	PE
•	•

**Door Options**

ALF	CG	CG.BTM	CG.TOP	DPSRR	MD	MD.BTM	MD.TOP	MFO
	•			•	• <sup>†</sup>			•

<sup>†</sup>Not available on 9" and 12" wide

**WALL DOUBLE DOOR, 39" HIGH**

24", 27", 30", 33", or 36"

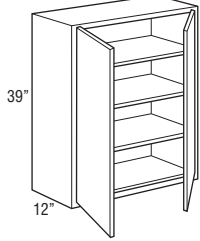

W2439  
W2739  
W3039  
W3339  
W3639

39", 42", 45", or 48"

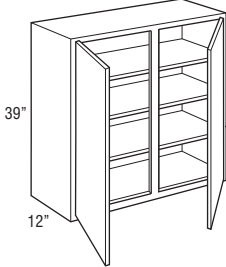

W3939  
W4239  
W4539  
W4839CS

48"

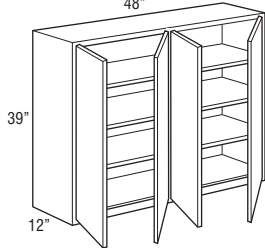

W4839

Model	Cubic Feet
W2439	8.2
W2739	9.1
W3039	10.0
W3339	11.0
W3639	11.9
W3939	11.8
W4239	13.8
W4539	15.6
W4839CS	16.9
W4839	16.9

**Custom Modifications**

ADDTK	AUTHL AUTHR	CBO	CCO	CFNTO	CFRMO	CND	EXBKL EXBKR	EXL EXR	FB	FFDL FFDR	FPEB
•	•	•	•	•	•		•	•	•	•	•
ID	INVERM	MIP	P	PFINBTMB	RD	TD	TVRAV TVRFV TVRVV	WLI			
•		•	•	•	•			•			

**Construction Upgrades**

APC	PE
•	•

**Door Options**

ALF	CG	CG.BTM	CG.TOP	DPSRR	MD	MD.BTM	MD.TOP	MFO
	•			•	•†			•

†Not available on 39" wide

**WALL SINGLE DOOR, 42" HIGH**

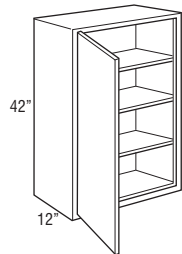

W942 L or R	4.0
W1242 L or R	5.1
W1542 L or R	6.2
W1842 L or R	7.3
W2142 L or R	8.3
W2442 L or R	9.4

**Custom Modifications**

ADDTK	AUTHL AUTHR	CBO	CCO	CFNTO	CFRMO	CND	EXBKL EXBKR	EXL EXR	FB	FFDL FFDR	FPEB
•	•	•	•	•	•		•	•	•	•	•
ID	INVERM	MIP	P	PFINBTMB	RD	TD	TVRAV TVRFV TVRVV	WLI			
•		•	•	•	•			•			

**Construction Upgrades**

APC	PE
•	•

**Door Options**

ALF	CG	CG.BTM	CG.TOP	DPSRR	MD	MD.BTM	MD.TOP	MFO
	•			•	•†			•

†Not available on 9" and 12" wide

**WALL DOUBLE DOOR, 42" HIGH**

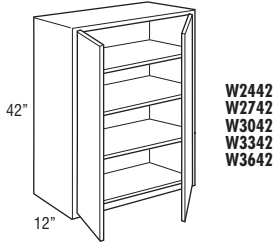

W2442  
W2742  
W3042  
W3342  
W3642

39", 42", 45", or 48"

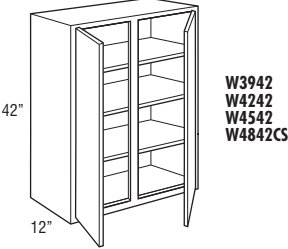

W3942  
W4242  
W4542  
W4842CS

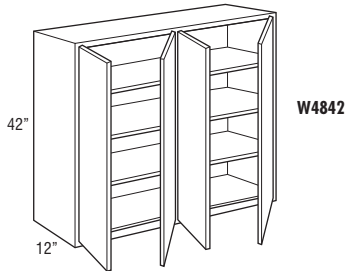

W4842

Model	Cubic Feet
W2442	9.4
W2742	10.4
W3042	11.5
W3342	12.6
W3642	13.7
W3942	14.8
W4242	15.9
W4542	17.0
W4842CS	18.1
W4842	18.1

**Custom Modifications**

	AUTHL	AUTHR	CBO	CCO	CFNTO	CFRMO	CND	EXBKL	EXBKR	EXL	EXR	FB	FFDL	FFDR	FPFB
•	•	•	•	•	•	•		•	•	•	•	•	•	•	•
ID	INVFRM	MIP	P	PFNBMTB	RD	TD		TVRAV	TVRFV	TVRVV	WLI				
•		•	•	•	•			•			•				

**Construction Upgrades**

APC	PE
•	•

**Door Options**

ALF	CG	CG.BTM	CG.TOP	DPSRR	MD	MD.BTM	MD.TOP	MFO
	•			•	• <sup>†</sup>			•

<sup>†</sup>Not available on 39" wide

**WALL EASY ACCESS STORAGE CABINET, 30" HIGH**

LOGIX

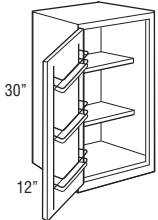

WEAS1530 L or R  
WEAS1830 L or R

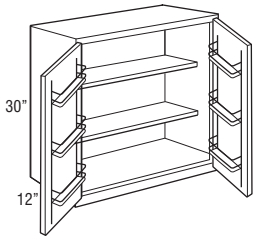

WEAS3030  
WEAS3630

WEAS1530 L or R	4.5
WEAS1830 L or R	5.3
WEAS3030	8.5
WEAS3630	10.0

- Adjustable shelves are 7 1/2" deep.
- Each door features a chrome and wood three-tiered rack.
- Door rack width is 9 3/8" on 15" and 30" wide cabinets.
- Door rack width is 12 3/8" on 18" and 36" wide cabinets.
- Door rack depth is 3 1/2".

**Custom Modifications**

	AUTHL	AUTHR	CBO	CCO	CFNTO	CFRMO	CND	EXBKL	EXBKR	EXL	EXR	FB	FFDL	FFDR	FPFB
•	•	•	•	•	•	•		•	•	•	•	•	•	•	•
ID	INVFRM	MIP	P	PFNBMTB	RD	TD		TVRAV	TVRFV	TVRVV	WLI				
		•		•				•			•				

**Construction Upgrades**

APC	PE
•	•

**Door Options**

ALF	CG	CG.BTM	CG.TOP	DPSRR	MD	MD.BTM	MD.TOP	MFO
				•				•

**WALL TWO DRAWER CABINET,  
18" HIGH, 12" DEEP**

12", 15", 18", 21", 24",  
27", 30", 33", or 36"

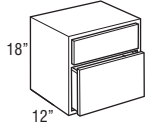

Model	Cubic Feet
W2D1218	2.2
W2D1518	2.7
W2D1818	3.2
W2D2118	3.8
W2D2418	4.3
W2D2718	4.7
W2D3018	5.2
W2D3318	5.6
W2D3618	6.1

- Drawer front to face frame reveal is justified to the top to be consistent with both full and partial overlay. Bottom reveal is 1" for both full and partial overlay.

**Custom Modifications**

ADDTK	AUTHL AUTHR	CBO	CCO	CFNT0	CFRMO	CND	EXBKL EXBKR	EXL EXR	FB	FFDL FFDR	FPFB
•	•	•	•		•		•	•	•		•
ID	INVERM	MIP	P	PFINBTMB	RD	TD	TVRAV TVRFV TVRVV	WLI			
•		•									

**Construction Upgrades**

APC	PE
•	•

**Door Options**

ALF	CG	CG.BTM	CG.TOP	DPSRR	MD	MD.BTM	MD.TOP	MFO

**WALL TWO DRAWER SINGLE DOOR  
CABINET, 48", 51", 54", 57",  
or 60" HIGH, 12" DEEP**

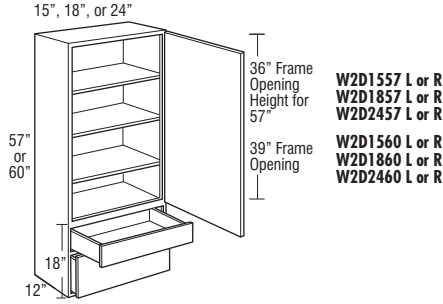
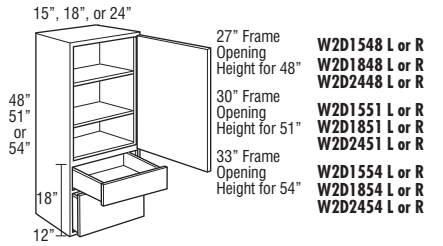

Model	Cubic Feet
W2D1548 L or R	6.5
W2D1848 L or R	7.8
W2D2448 L or R	10.4
W2D1551 L or R	7.5
W2D1851 L or R	8.9
W2D2451 L or R	11.6
W2D1554 L or R	7.2
W2D1854 L or R	8.5
W2D2454 L or R	11.1
W2D1557 L or R	7.5
W2D1857 L or R	8.9
W2D2457 L or R	11.7
W2D1560 L or R	7.9
W2D1860 L or R	9.4
W2D2460 L or R	12.3

• Drawer front to face frame reveal is justified to the top to be consistent with both full and partial overlay. Bottom reveal is 1" for both full and partial overlay.

**Custom Modifications**

ADDTK	AUTHL AUTHR	CBO	CCO	CFNTO	CFRMO	CND	EXBKL EXBKR	EXL EXR	FB	FFDL FFDR	FPEB
•	•	•	•		•	•	•	•	•		•
ID	INVFRM	MIP	P	PFINBTMB	RD	TD	TVRAV TVRFV TVRVV	WLI			
•		•						•			

**Construction Upgrades**

APC	PE
•	•

**Door Options**

ALF	CG	CG.BTM	CG.TOP	DPSRR	MD	MD.BTM	MD.TOP	MFO
	•			•	•			•



**WALL TWO DRAWER DOUBLE DOOR CABINET, 48", 51", 54", 57", or 60" HIGH, 12" DEEP**

24", 27", 30", 33", or 36"

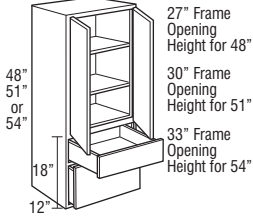

- 27" Frame Opening Height for 48"
  - W2D2448
  - W2D2748
  - W2D3048
- 30" Frame Opening Height for 51"
  - W2D3348
  - W2D3648
- 33" Frame Opening Height for 54"
  - W2D2451
  - W2D2751
  - W2D3051
  - W2D3351
  - W2D3651
- W2D2454
  - W2D2754
  - W2D3054
  - W2D3354
  - W2D3654

24", 27", 30", 33", or 36"

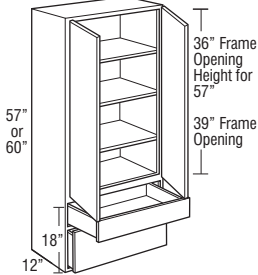

- 36" Frame Opening Height for 57"
  - W2D2457
  - W2D2757
  - W2D3057
  - W2D3357
  - W2D3657
- 39" Frame Opening
  - W2D2460
  - W2D2760
  - W2D3060
  - W2D3360
  - W2D3660

Model	Cubic Feet
W2D2448	10.4
W2D2748	11.8
W2D3048	13.1
W2D3348	14.3
W2D3648	15.6
W2D2451	11.6
W2D2751	12.6
W2D3051	13.9
W2D3351	15.2
W2D3651	16.5
W2D2454	11.1
W2D2754	13.3
W2D3054	14.7
W2D3354	16.1
W2D3654	17.5
W2D2457	11.7
W2D2757	14.0
W2D3057	15.5
W2D3357	16.9
W2D3657	18.4
W2D2460	12.3
W2D2760	14.7
W2D3060	16.3
W2D3360	17.8
W2D3660	19.4

• Drawer front to face frame reveal is justified to the top to be consistent with both full and partial overlay. Bottom reveal is 1" for both full and partial overlay.

**Custom Modifications**

ADDTK	AUHL AUTHR	CBO	CCO	CFNTO	CFRMO	CND	EXBKL EXBKR	EXL EXR	FB	FFDL FFDR	FPFB
•	•	•	•		•	•	•	•	•		•
ID	INVERM	MIP	P	PFINBTMB	RD	TD	TVRAV TVRFV TVRVV	WLI			
•		•						•			

**Construction Upgrades**

APC	PE
•	•

**Door Options**

ALF	CG	CG.BTM	CG.TOP	DPSRR	MD	MD.BTM	MD.TOP	MFO
	•			•	•			•

**WALL THREE DRAWER SINGLE DOOR,  
48", 51", 54", 57", or 60" HIGH**

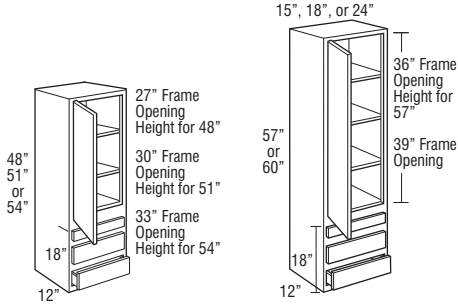

W3D1548 L or R  
W3D1848 L or R  
W3D2448 L or R

W3D1551 L or R  
W3D1851 L or R  
W3D2451 L or R

W3D1554 L or R  
W3D1854 L or R  
W3D2454 L or R

W3D1557 L or R  
W3D1857 L or R  
W3D2457 L or R

W3D1560 L or R  
W3D1860 L or R  
W3D2460 L or R

Model	Cubic Feet
W3D1548 L or R	6.5
W3D1848 L or R	7.8
W3D2448 L or R	10.4
W3D1551 L or R	7.5
W3D1851 L or R	8.9
W3D2451 L or R	11.6
W3D1554 L or R	7.2
W3D1854 L or R	8.5
W3D2454 L or R	11.1
W3D1557 L or R	8.3
W3D1857 L or R	9.7
W3D2457 L or R	12.7
W3D1560 L or R	7.9
W3D1860 L or R	9.4
W3D2460 L or R	12.3

- Includes one shallow depth drawer and two standard drawers.
- Top drawer will be slab drawer front for all 5-piece drawer and Drawer Front Raised applications.
- Drawer front to face frame reveal is justified to the top to be consistent with both full and partial overlay. Bottom reveal is 1" for both full and partial overlay.

**Custom Modifications**

ADDTK	AUTHL AUTHR	CBO	CCO	CFNTO	CFRMO	CND	EXBKL EXBKR	EXL EXR	FB	FFDL FFDR	FPEB
•	•	•	•		•	•	•	•	•		•
ID	INVERM	MIP	P	PFINBTMB	RD	TD	TBRAV TVRFV TVRVV	WLI			
•		•						•			

**Construction Upgrades**

APC	PE
•	•

**Door Options**

ALF	CG	CG.BTM	CG.TOP	DPSRR	MD	MD.BTM	MD.TOP	MFO
	•			•	•			•

**WALL THREE DRAWER DOUBLE DOOR,  
48", 51", 54", 57", or 60" HIGH**

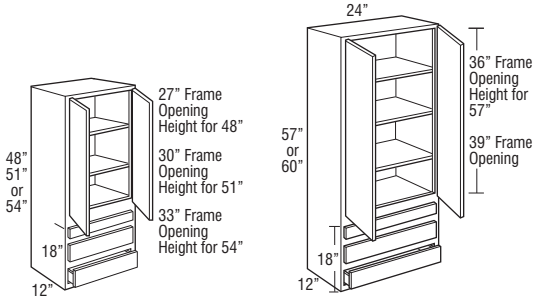

**W3D2448  
W3D2451  
W3D2454**

**W3D2457  
W3D2460**

Model	Cubic Feet
<b>W3D2448</b>	10.4
<b>W3D2451</b>	11.6
<b>W3D2454</b>	11.1
<b>W3D2457</b>	12.7
<b>W3D2460</b>	12.3

- Includes one shallow depth drawer and two standard drawers.
- Top drawer will be slab drawer front for all 5-piece drawer and Drawer Front Raised applications.
- Drawer front to face frame reveal is justified to the top to be consistent with both full and partial overlay. Bottom reveal is 1" for both full and partial overlay.

**Custom Modifications**

ADDTK	AUTHL AUTHR	CBO	CCO	CFNTO	CFRMO	CND	EXBKL EXBKR	EXL EXR	FB	FFDL FFDR	FPFB
•	•	•	•		•	•	•	•	•		•
ID	INVERM	MIP	P	PFINBTMB	RD	TD	TVRAV TVRFV TVRVV	WLI			
•		•						•			

**Construction Upgrades**

APC	PE
•	•

**Door Options**

ALF	CG	CG.BTM	CG.TOP	DPSRR	MD	MD.BTM	MD.TOP	MFO
	•			•	•			•

**STACKED WALL CABINETS SINGLE DOOR, 48", 51", 54", 57", or 60" HIGH**

12", 15", 18", 21", or 24"

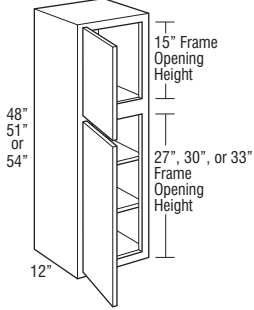

12", 15", 18", 21", or 24"

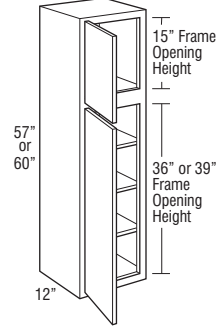

Model	Cubic Feet
STW1248 L or R	5.8
STW1548 L or R	7.0
STW1848 L or R	8.3
STW2148 L or R	9.5
STW2448 L or R	10.7
STW1251 L or R	6.2
STW1551 L or R	7.5
STW1851 L or R	8.9
STW2151 L or R	10.2
STW2451 L or R	11.6
STW1254 L or R	6.5
STW1554 L or R	7.9
STW1854 L or R	9.3
STW2154 L or R	10.6
STW2454 L or R	12.0
STW1257 L or R	6.8
STW1557 L or R	8.3
STW1857 L or R	9.4
STW2157 L or R	11.2
STW2457 L or R	12.7
STW1260 L or R	7.2
STW1560 L or R	8.7
STW1860 L or R	10.2
STW2160 L or R	11.8
STW2460 L or R	13.3

• Bottom doors will always be square.

**Custom Modifications**

ADDTK	AUTHL AUTHR	CBO	CCO	CFNTO	CFRMO	CND	EXBKL EXBKR	EXL EXR	FB	FFDL FFDR	FPEB
•	•	•	•	•	•		•	•	•	•	•
ID	INVFRM	MIP	P	PFINBTMB	RD	TD	TGRAV TVRFV TVRVV	WLI			
•	•	•	•		•	•		•			

**Construction Upgrades**

APC	PE
•	•

**Door Options**

ALF	CG	CG.BTM	CG.TOP	DPSRR	MD	MD.BTM	MD.TOP	MFO
		•	•	•		• <sup>†</sup>	• <sup>†</sup>	•

<sup>†</sup>Not available on 12", 21", and 24" wide

**STACKED WALL CABINETS DOUBLE DOOR, 48", 51", 54", 57", or 60" HIGH**

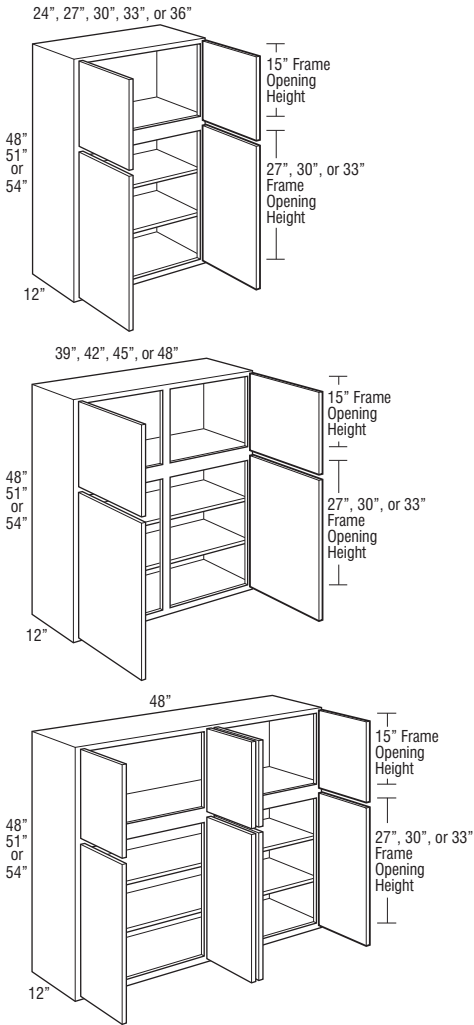

Model	Cubic Feet
STW2448	10.7
STW2748	12.0
STW3048	13.2
STW3348	14.4
STW3648	15.7
STW2451	11.6
STW2751	12.9
STW3051	14.3
STW3351	15.6
STW3651	17.0
STW2454	12.0
STW2754	13.4
STW3054	14.8
STW3354	16.2
STW3654	17.5
STW3948	16.9
STW4248	18.1
STW4548	19.0
STW4848CS	20.6
STW3951	18.3
STW4251	19.7
STW4551	20.2
STW4851CS	22.4
STW3954	18.9
STW4254	20.4
STW4554	21.3
STW4854CS	25.9
STW4848	20.6
STW4851	22.4
STW4854	25.9

• Bottom doors will always be square.

**Custom Modifications**

ADDTK	AUHL AUTHR	CBO	CCO	CFNTO	CFRMO	CND	EXBKL EXBKR	EXL EXR	FB	FFDL FFDR	FPFB
•	•	•	•	•	•		•	•	•	•	•
ID	INVERM	MIP	P	PFINBTMB	RD	TD	TVRAV TVRFV TVRVV	WLI			
•	•	•	•*		•	•*		•			

\*Not available on 39", 42", 45", and 48" wide

**Construction Upgrades**

APC	PE
•	•

**Door Options**

ALF	CG	CG.BTM	CG.TOP	DPSRR	MD	MD.BTM	MD.TOP	MFO
		•	•	•		• <sup>†</sup>	• <sup>†</sup>	•

<sup>†</sup>Available only on 30" and 36" wide

**STACKED WALL CABINETS DOUBLE DOOR, 48", 51", 54", 57", or 60" HIGH (cont'd)**

24", 27", 30", 33", or 36"

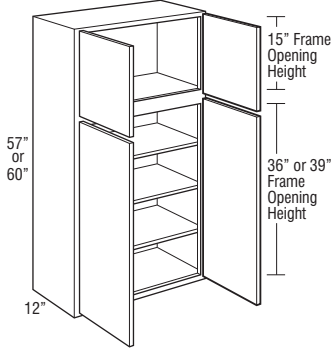

39", 42", 45", or 48"

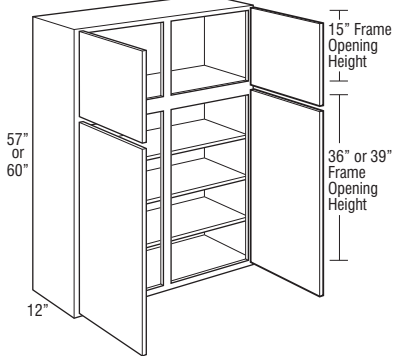

48"

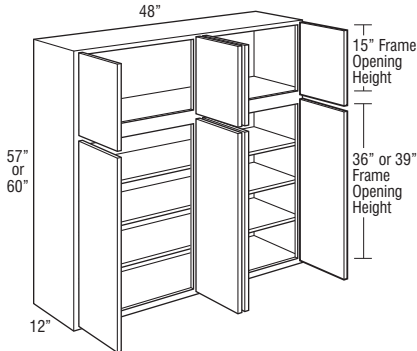

Model	Cubic Feet
STW2457	12.7
STW2757	14.2
STW3057	15.6
STW3357	17.1
STW3657	18.5
STW2460	13.3
STW2760	14.9
STW3060	16.4
STW3360	17.9
STW3660	19.4
STW3957	20.0
STW4257	21.4
STW4557	22.5
STW4857CS	24.3
STW3960	21.0
STW4260	22.5
STW4560	23.6
STW4860CS	31.7
STW4857	24.3
STW4860	31.7

• Bottom doors will always be square.

**Custom Modifications**

ADDTK	AUTHL AUTHR	CBO	CCO	CFNT0	CFRMO	CND	EXBKL EXBKR	EXL EXR	FB	FFDL FFDR	FPFB
•	•	•	•	•	•		•	•	•	•	•
ID	INVFRM	MIP	P	PFNBMB	RD	TD	TVRAV TVRFV TVRVV	WLI			
•	•	•	•*		•	•*		•			

\*Not available on 39", 42", 45", and 48" wide

**Construction Upgrades**

APC	PE
•	•

**Door Options**

ALF	CG	CG.BTM	CG.TOP	DPSRR	MD	MD.BTM	MD.TOP	MFO
		•	•	•		•†	•†	•

†Available only on 30" and 36" wide

### Wall Corner Cabinets

- Wall corner cabinets may be installed flush to the wall (left) or pulled up to 3" away from wall (right) to accommodate odd dimensions in a kitchen design. In either case, the adjoining run of 12" wall cabinets plus a 3" filler will butt against the solid-wood panel.
- When a cabinet is "pulled" it will use proportionally more wall space, for example, a 30" wide WC pulled 2" will use 32" of space.
- The L or R in the cabinet's nomenclature indicates the location of cabinet void.
- Blind side of wall corner cabinets cannot be installed next to a range hood or microwave shelf unit due to door interference.

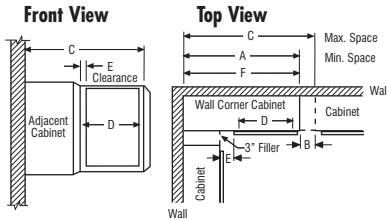

NOTE: All outside stiles are 1 1/2" wide

Model	A Min. Space	B Max. Pull*	C Max. Space	D Cabinet Opening	E*		E		F Actual Cabinet
					Full Overlay At Min.	At Max.	Partial Overlay At Min.	At Max.	
WC24..	24"	5"	29"	7 1/2"	1 3/4"	6 3/4"	2 1/2"	7 1/2"	24"
WC27..	27"	4 1/2"	31 1/2"	9"	3 1/4"	7 3/4"	4"	8 1/2"	27"
WC30..	30"	5"	35"	13 1/2"	1 3/4"	6 3/4"	2 1/2"	7 1/2"	30"
WC33..	33"	4 1/2"	37 1/2"	15"	3 1/4"	7 3/4"	4"	8 1/2"	33"
WC36..	36"	5"	41"	19 1/2"	1 3/4"	6 3/4"	2 1/2"	7 1/2"	36"
WC39..	39"	4 1/2"	43 1/2"	21"	3 1/4"	7 3/4"	4"	8 1/2"	39"
WC42..	42"	4 1/2"	46 1/2"	24"	3 1/4"	7 3/4"	4"	8 1/2"	42"
WC45..	45"	4 1/2"	49 1/2"	27"	3 1/4"	7 3/4"	4"	8 1/2"	45"
WC48..	48"	4 1/2"	52 1/2"	30"	3 1/4"	7 3/4"	4"	8 1/2"	48"

\*Minimum/maximum space between inside edge of door and face of filler/adjoining cabinet.  
If cabinet is pulled to maximum stated dimension, filler will need to be cleated for proper attachment.

Model	Cubic Feet
WC2424 L or R	5.5
WC2724 L or R	6.1
WC3024 L or R	6.8

### WALL CORNER SINGLE DOOR, 24" HIGH

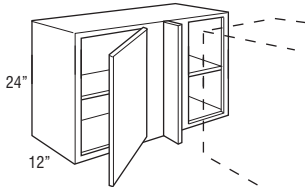

- Face Frame and Door on End modification not available on the void side of the cabinet.
- Includes one 3" filler, shipped unattached.
- L or R indicates void. R (right) void shown.

#### Custom Modifications

ADDTK	AUTHL AUTHR	CBO	CCO	CFNTO	CFRMO	CND	EXBKL EXBKR	EXL EXR	FB	FFDL FFDR	FPFB
•	•	•	•	•	•		•	•	•	•	•
ID	INVERM	MIP	P	PFINBTMB	RD	TD	TVRAV TVRFV TVRVV	WLI			
•		•	•	•	•			•			

#### Construction Upgrades

APC	PE
•	•

#### Door Options

ALF	CG	CG.BTM	CG.TOP	DPSRR	MD	MD.BTM	MD.TOP	MFO
	•			•				•

**WALL CORNER SINGLE DOOR,  
30", 33", or 36" HIGH**

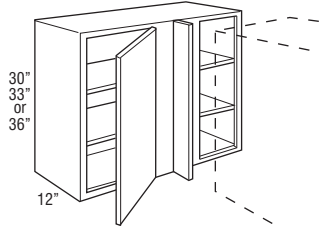

Model	Cubic Feet
WC2430 L or R	6.9
WC2730 L or R	7.7
WC3030 L or R	8.5
WC3330 L or R	9.5
WC3630 L or R	10.0
WC2433 L or R	7.6
WC2733 L or R	8.5
WC3033 L or R	9.4
WC3333 L or R	10.3
WC3633 L or R	11.2
WC2436 L or R	8.2
WC2736 L or R	9.1
WC3036 L or R	10.0
WC3336 L or R	11.1
WC3636 L or R	11.9

- Face Frame and Door on End modification not available on the void side of the cabinet.
- Includes one 3" filler, shipped unattached.
- L or R indicates void. R (right) void shown.

**Custom Modifications**

ADTK	AUTHL AUTHR	CBO	CCO	CFNTO	CFRMO	CND	EXBKL EXBKR	EXL EXR	FB	FFDL FFDR	FPEB
•	•	•	•	•	•		•	•	•	•	•
ID	INVFRM	MIP	P	PFNBMB	RD	TD	TVRAV TVRFV TVRVV	WLI			
•	•	•	•	•	•			•			

**Construction Upgrades**

APC	PE
•	•

**Door Options**

ALF	CG	CG.BTM	CG.TOP	DPSRR	MD	MD.BTM	MD.TOP	MFO
	•			•	• <sup>†</sup>			•

<sup>†</sup>Available only on 33" and 36" wide



**WALL CORNER DOUBLE DOOR,  
30", 33", or 36" HIGH**

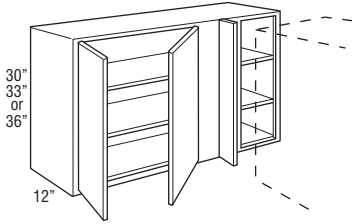

Model	Cubic Feet
WC3930 L or R	10.3
WC4230 L or R	11.6
WC4530 L or R	12.2
WC4830 L or R	13.2
WC3933 L or R	11.7
WC4233 L or R	12.6
WC4533 L or R	13.5
WC4833 L or R	14.3
WC3936 L or R	12.7
WC4236 L or R	13.7
WC4536 L or R	14.6
WC4836 L or R	15.6

- Face Frame and Door on End modification not available on the void side of the cabinet.
- Includes one 3" filler, shipped unattached.
- L or R indicates void. R (right) void shown.
- On 39" wide cabinets, Peninsula and Mullion Door options cannot be ordered together due to the unavailability of Mullion Doors for the double door side.

**Custom Modifications**

ADDTK	AUTHL AUTHR	CBO	CCO	CFNT0	CFRMO	CND	EXBKL EXBKR	EXL EXR	FB	FFDL FFDR	FPEB
•	•	•	•	•	•		•	•	•	•	•
ID	INVERM	MIP	P	PENBTMB	RD	TD	TVRAV TVRFV TVRVV	WLI			
•		•	•	•	•			•			

**Construction Upgrades**

APC	PE
•	•

**Door Options**

ALF	CG	CG.BTM	CG.TOP	DPSRR	MD	MD.BTM	MD.TOP	MFO
	•			•	•			•

**WALL CORNER SINGLE DOOR,  
39" or 42" HIGH**

24", 27", 30", 33", or 36"

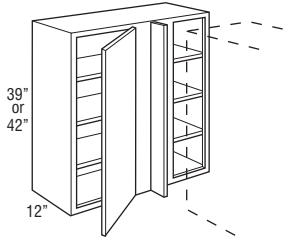

Model	Cubic Feet
WC2439 L or R	8.8
WC2739 L or R	9.8
WC3039 L or R	10.8
WC3339 L or R	11.8
WC3639 L or R	12.5
WC2442 L or R	9.4
WC2742 L or R	10.5
WC3042 L or R	11.6
WC3342 L or R	12.7
WC3642 L or R	13.8

- Face Frame and Door on End modification not available on the void side of the cabinet.
- Includes one 3" filler, shipped unattached.
- L or R indicates void. R (right) void shown.

**Custom Modifications**

	ADDTK	AUTHL AUTHR	CBO	CCO	CFNTO	CFRMO	CND	EXBKL EXBKR	EXL EXR	FB	FFDL FFDR	FPEB
	•	•	•	•	•	•		•	•	•	•	•
ID	INVERM	MIP	P	PFNBMB	RD	TD	TVRAV TVRFV TVRVV	WLI				
•	•	•	•	•	•			•				

**Construction Upgrades**

APC	PE
•	•

**Door Options**

ALF	CG	CG.BTM	CG.TOP	DPSRR	MD	MD.BTM	MD.TOP	MFO
	•			•	• <sup>†</sup>			•

<sup>†</sup>Available only on 33" and 36" wide

**WALL CORNER DOUBLE DOOR,  
39" or 42" HIGH**

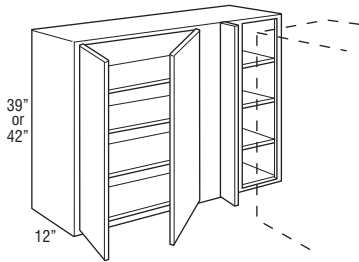

WC3939 L or R	13.8
WC4239 L or R	14.8
WC4539 L or R	15.8
WC4839 L or R	16.8
WC3942 L or R	14.8
WC4242 L or R	15.9
WC4542 L or R	17.0
WC4842 L or R	18.1

- Face Frame and Door on End modification not available on the void side of the cabinet.
- Includes one 3" filler, shipped unattached.
- L or R indicates void. R (right) void shown.
- On 39" wide cabinets, Peninsula and Mullion Door options cannot be ordered together due to the unavailability of Mullion Doors for the double door side.

**Custom Modifications**

	ADDTK	AUTHL AUTHR	CBO	CCO	CFNTO	CFRMO	CND	EXBKL EXBKR	EXL EXR	FB	FFDL FFDR	FPEB
	•	•	•	•	•	•		•	•	•	•	•
ID	INVERM	MIP	P	PFNBMB	RD	TD	TVRAV TVRFV TVRVV	WLI				
•	•	•	•	•	•			•				

**Construction Upgrades**

APC	PE
•	•

**Door Options**

ALF	CG	CG.BTM	CG.TOP	DPSRR	MD	MD.BTM	MD.TOP	MFO
	•			•	•			•

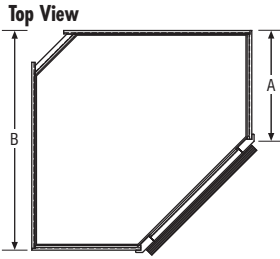

Diagonal Wall Cabinets with Increased or Reduced Depth

		RD9	RD10	RD11	STD	ID13	ID14	ID15	ID16	ID17	ID18	ID19	ID20	ID21	ID22	ID23	ID24
Cabinet Depth	A	9"	10"	11"	12"	13"	14"	15"	16"	17"	18"	19"	20"	21"	22"	23"	24"
Wall Space	B	21"	22"	23"	24"	25"	26"	27"	28"	29"	30"	31"	32"	33"	34"	35"	36"

**DIAGONAL WALL, 12", 15", or 18" HIGH, 24" x 24"**

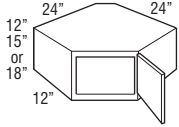

Model	Cubic Feet
DW122424 L or R	5.5
DW152424 L or R	6.7
DW182424 L or R	7.8

- Cabinets require 24" x 24" of corner wall space.
- Full overlay styles use HINGEQRPO, see page 429.

Custom Modifications

ADDTK	AUTHL AUTHR	CBO	CCO	CFNTO	CFRMO	CND	EXBKL EXBKR	EXL EXR	FB	FFDL FFDR	FPFB
	•		•	•	•				•	•*	•
ID	INVERM	MIP	P	PFINBTMB	RD	TD	TVRAV TVRFV TVRVV	WLI			
•		•		•	•			•			

\*Available only on 18" high

Construction Upgrades

APC	PE
•	•

Door Options

ALF	CG	CG.BTM	CG.TOP	DPSRR	MD	MD.BTM	MD.TOP	MFO
	•			•				•

**DIAGONAL WALL, 24" or 27" HIGH, 24" x 24"**

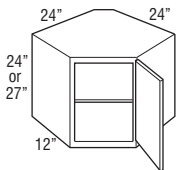

Model	Cubic Feet
DW242424 L or R	10.2
DW272424 L or R	11.3

- Cabinets require 24" x 24" of corner wall space.
- Adjustable shelf cannot be removed/retrofitted.
- Full overlay styles use HINGEQRPO, see page 429.

Custom Modifications

ADDTK	AUTHL AUTHR	CBO	CCO	CFNTO	CFRMO	CND	EXBKL EXBKR	EXL EXR	FB	FFDL FFDR	FPFB
	•	•	•	•	•				•	•	•
ID	INVERM	MIP	P	PFINBTMB	RD	TD	TVRAV TVRFV TVRVV	WLI			
•		•		•	•			•			

Construction Upgrades

APC	PE
•	•

Door Options

ALF	CG	CG.BTM	CG.TOP	DPSRR	MD	MD.BTM	MD.TOP	MFO
	•			•				•

**DIAGONAL WALL, 30", 33", 36", 39", or 42" HIGH, 24" x 24"**

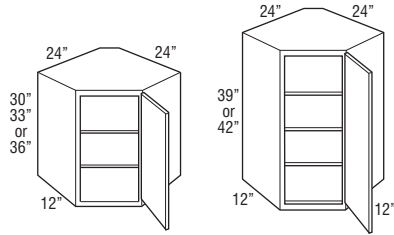

DW302424 L or R  
DW332424 L or R  
DW362424 L or R

DW392424 L or R  
DW422424 L or R

Model	Cubic Feet
DW302424 L or R	12.5
DW332424 L or R	13.9
DW362424 L or R	14.9
DW392424 L or R	16.0
DW422424 L or R	17.2

- Cabinets require 24" x 24" of corner wall space.
- Adjustable shelves.
- Full overlay styles use HINGEQRPO, see page 429.

**Custom Modifications**

ADDTK	AUTHL AUTHR	CBO	CCO	CFNTO	CFRMO	CND	EXBKL EXBKR	EXL EXR	FB	FFDL FFDR	FPEB
	•	•	•	•	•				•	•	•
ID	INVERM	MIP	P	PFNBTAB	RD	TD	TVRAV TVRFV TVRVV	WLI			
•		•		•	•			•			

**Construction Upgrades**

APC	PE
•	•

**Door Options**

ALF	CG	CG.BTM	CG.TOP	DPSRR	MD	MD.BTM	MD.TOP	MFO
	•			•	•			•

**DIAGONAL WALL, 12", 15", or 18" HIGH, 27" x 27"**

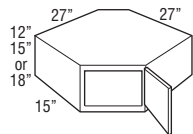

DW122727 L or R	6.8
DW152727 L or R	8.3
DW182727 L or R	9.7

- Cabinets require 27" x 27" of corner wall space.
- Full overlay styles use HINGEQRPO, see page 429.

**Custom Modifications**

ADDTK	AUTHL AUTHR	CBO	CCO	CFNTO	CFRMO	CND	EXBKL EXBKR	EXL EXR	FB	FFDL FFDR	FPEB
	•		•	•	•				•	•*	•
ID	INVERM	MIP	P	PFNBTAB	RD	TD	TVRAV TVRFV TVRVV	WLI			
•		•		•	•			•			

\*Available only on 18" high

**Construction Upgrades**

APC	PE
•	•

**Door Options**

ALF	CG	CG.BTM	CG.TOP	DPSRR	MD	MD.BTM	MD.TOP	MFO
	•			•				•

**DIAGONAL WALL, 24" or 27" HIGH, 27" x 27"**

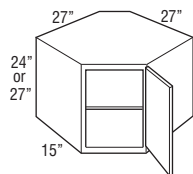

DW242727 L or R	12.7
DW272727 L or R	14.1

- Cabinets require 27" x 27" of corner wall space.
- Adjustable shelf cannot be removed/retrofitted.
- Full overlay styles use HINGEQRPO, see page 429.

**Custom Modifications**

ADDTK	AUTHL AUTHR	CBO	CCO	CFNTO	CFRMO	CND	EXBKL EXBKR	EXL EXR	FB	FFDL FFDR	FPEB
	•	•	•	•	•				•	•	•
ID	INVERM	MIP	P	PFNBTAB	RD	TD	TVRAV TVRFV TVRVV	WLI			
•		•		•	•			•			

**Construction Upgrades**

APC	PE
•	•

**Door Options**

ALF	CG	CG.BTM	CG.TOP	DPSRR	MD	MD.BTM	MD.TOP	MFO
	•			•				•

**DIAGONAL WALL, 30", 33", 36", 39",  
or 42" HIGH, 27" x 27"**

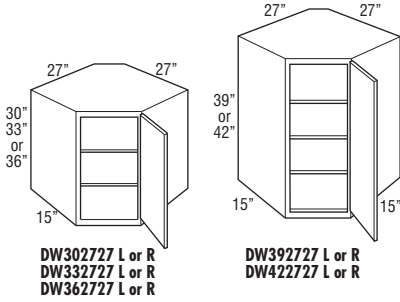

Model	Cubic Feet
DW302727 L or R	14.7
DW332727 L or R	16.1
DW362727 L or R	17.6
DW392727 L or R	20.0
DW422727 L or R	20.5

- Cabinets require 27" x 27" of corner wall space.
- Full overlay styles use HINGEQRPO, see page 429.

**Custom Modifications**

ADDTK	AUTHL AUTHR	CBO	CCO	CFNTO	CFRMO	CND	EXBKL EXBKR	EXL EXR	FB	FFDL FFDR	FPFB
	•	•	•	•	•				•	•	•
ID	INVERM	MIP	P	PFINBTMB	RD	TD	TVRAV TVRFV TVRVV	WLI			
•		•		•	•			•			

**Construction Upgrades**

APC	PE
•	•

**Door Options**

ALF	CG	CG.BTM	CG.TOP	DPSRR	MD	MD.BTM	MD.TOP	MFO
	•			•	•			•

**DIAGONAL WALL with LAZY SUSAN,  
30", 33", 36", 39", or 42" HIGH,  
24" x 24"**

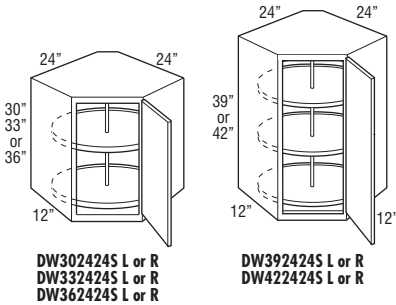

DW302424S L or R	12.5
DW332424S L or R	13.9
DW362424S L or R	14.9
DW392424S L or R	16.0
DW422424S L or R	17.2

- Cabinets require 24" x 24" of corner wall space.
- Plywood shelves are 18" in overall diameter with a 17" interior diameter and 1" high lip.
- Shelves rotate independently.
- Full overlay styles use HINGEQRPO, see page 429.

**Custom Modifications**

ADDTK	AUTHL AUTHR	CBO	CCO	CFNTO	CFRMO	CND	EXBKL EXBKR	EXL EXR	FB	FFDL FFDR	FPFB
	•	•	•	•	•				•	•	•
ID	INVERM	MIP	P	PFINBTMB	RD	TD	TVRAV TVRFV TVRVV	WLI			
		•		•				•			

**Construction Upgrades**

APC	PE
•	•

**Door Options**

ALF	CG	CG.BTM	CG.TOP	DPSRR	MD	MD.BTM	MD.TOP	MFO
	•			•	•			•

**DIAGONAL WALL with TAMBOUR,  
48", 51", 54", 57", or 60" HIGH,  
24" x 24"**

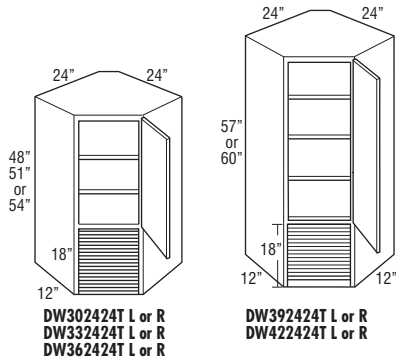

DW302424T L or R  
DW332424T L or R  
DW362424T L or R

DW392424T L or R  
DW422424T L or R

Model	Cubic Feet
DW302424T L or R	19.6
DW332424T L or R	21.0
DW362424T L or R	21.9
DW392424T L or R	23.9
DW422424T L or R	24.3

- Cabinets require 24" x 24" of corner wall space.
- Full overlay styles use HINGEORPO, see page 429.

**Custom Modifications**

	AUTHL AUTHR	CBO	CCO	CFNTD	CFRMO	CND	EXBKL EXBKR	EXL EXR	FB	FFDL FFDR	FPEB
	•	•	•	•	•				•		•
ID	INVERM	MIP	P	PFNBTAB	RD	TD	TVRAV TVRFV TVRVV	WLI			
•		•			•			•			

**Construction Upgrades**

APC	PE
•	•

**Door Options**

ALF	CG	CG.BTM	CG.TOP	DPSRR	MD	MD.BTM	MD.TOP	MFO
	•			•	•			•

**DIAGONAL WALL with LOWER DOOR,  
48", 51", 54", 57", or 60" HIGH,  
24" x 24"**

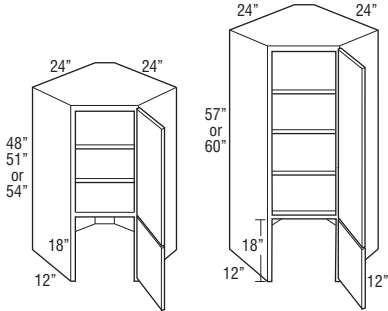

DW302424D L or R  
DW332424D L or R  
DW362424D L or R

DW392424D L or R  
DW422424D L or R

DW302424D L or R	19.6
DW332424D L or R	21.0
DW362424D L or R	21.9
DW392424D L or R	23.9
DW422424D L or R	24.3

- Cabinets require 24" x 24" of corner wall space.
- Bottom door will always be square.
- Bottom section does not have floor.
- Mullion Doors not available on bottom door.
- Full overlay styles use HINGEORPO, see page 429.

**Custom Modifications**

	AUTHL AUTHR	CBO	CCO	CFNTD	CFRMO	CND	EXBKL EXBKR	EXL EXR	FB	FFDL FFDR	FPEB
	•	•	•	•	•				•		•
ID	INVERM	MIP	P	PFNBTAB	RD	TD	TVRAV TVRFV TVRVV	WLI			
•		•			•			•			

**Construction Upgrades**

APC	PE
•	•

**Door Options**

ALF	CG	CG.BTM	CG.TOP	DPSRR	MD	MD.BTM	MD.TOP	MFO
		•	•	•			•	•

**DIAGONAL WALL with TAMBOUR,**  
48", 51", 54", 57", or 60" HIGH,  
27" x 27"

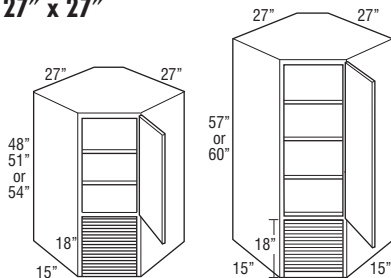

DW302727T L or R  
DW332727T L or R  
DW362727T L or R

DW392727T L or R  
DW422727T L or R

Model	Cubic Feet
DW302727T L or R	22.2
DW332727T L or R	23.1
DW362727T L or R	24.9
DW392727T L or R	25.7
DW422727T L or R	27.7

- Cabinets require 27" x 27" of corner wall space.
- Full overlay styles use HINGEQRPO, see page 429.

**Custom Modifications**

ADDTK	AUTHL AUTHR	CBO	CCO	CFNTO	CFRMO	CND	EXBKL EXBKR	EXL EXR	FB	FFDL FFDR	FPFB
	•	•	•	•	•				•		•
ID	INVFRM	MIP	P	PFINBTMB	RD	TD	TAVRAV TVRFV TVRVV	WLI			
•		•			•			•			

**Construction Upgrades**

APC	PE
•	•

**Door Options**

ALF	CG	CG.BTM	CG.TOP	DPSRR	MD	MD.BTM	MD.TOP	MFO
	•			•	•			•

**DIAGONAL WALL with LOWER DOOR,**  
48", 51", 54", 57", or 60" HIGH,  
27" x 27"

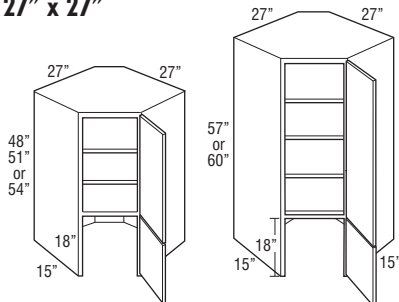

DW302727D L or R  
DW332727D L or R  
DW362727D L or R

DW392727D L or R  
DW422727D L or R

DW302727D L or R	22.2
DW332727D L or R	23.1
DW362727D L or R	24.9
DW392727D L or R	25.7
DW422727D L or R	27.7

- Cabinets require 27" x 27" of corner wall space.
- Bottom door will always be square.
- Bottom section does not have floor.
- Mullion Doors not available on bottom door.
- Full overlay styles use HINGEQRPO, see page 429.

**Custom Modifications**

ADDTK	AUTHL AUTHR	CBO	CCO	CFNTO	CFRMO	CND	EXBKL EXBKR	EXL EXR	FB	FFDL FFDR	FPFB
	•	•	•	•	•				•		•
ID	INVFRM	MIP	P	PFINBTMB	RD	TD	TAVRAV TVRFV TVRVV	WLI			
•		•			•			•			

**Construction Upgrades**

APC	PE
•	•

**Door Options**

ALF	CG	CG.BTM	CG.TOP	DPSRR	MD	MD.BTM	MD.TOP	MFO
		•	•	•			•	•

**DIAGONAL WALL with TAMBOUR and LAZY SUSAN, 48", 51", 54", 57", or 60" HIGH, 24" x 24"**

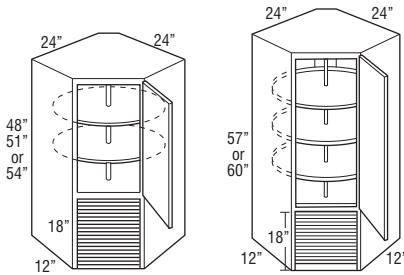

DW302424TS L or R  
DW332424TS L or R  
DW362424TS L or R

DW392424TS L or R  
DW422424TS L or R

Model	Cubic Feet
DW302424TS L or R	19.6
DW332424TS L or R	21.0
DW362424TS L or R	21.9
DW392424TS L or R	23.9
DW422424TS L or R	24.3

- Cabinets require 24" x 24" of corner wall space.
- Plywood shelves are 18" in overall diameter with a 17" interior diameter and 1" high lip.
- Shelves rotate independently.
- Full overlay styles use HINGEORPO, see page 429.

**Custom Modifications**

ADDTK	AUTHL AUTHR	CBO	CCO	CFNTO	CFRMO	CND	EXBKL EXBKR	EXL EXR	FB	FFDL FFDR	FPEB
	•	•	•	•	•				•		•
ID	INVFRM	MIP	P	PFNBTAB	RD	TD	TAVR TVRFV TVRVV	WLI			
		•						•			

**Construction Upgrades**

APC	PE
•	•

**Door Options**

ALF	CG	CG.BTM	CG.TOP	DPSRR	MD	MD.BTM	MD.TOP	MFO
	•			•	•			•

**DIAGONAL WALL with LOWER DOOR and LAZY SUSAN, 48", 51", 54", 57", or 60" HIGH, 24" x 24"**

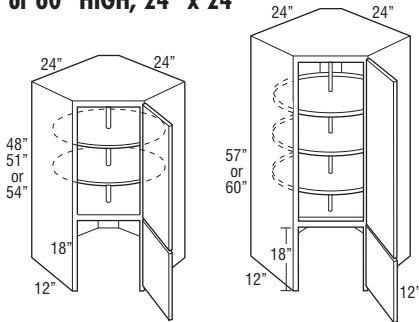

DW302424DS L or R  
DW332424DS L or R  
DW362424DS L or R

DW392424DS L or R  
DW422424DS L or R

DW302424DS L or R	19.6
DW332424DS L or R	21.0
DW362424DS L or R	21.9
DW392424DS L or R	23.9
DW422424DS L or R	24.3

- Cabinets require 24" x 24" of corner wall space.
- Bottom door will always be square.
- Bottom section does not have floor.
- Mullion Doors not available on bottom door.
- Plywood shelves are 18" in overall diameter with a 17" interior diameter and 1" high lip.
- Shelves rotate independently.
- Full overlay styles use HINGEORPO, see page 429.

**Custom Modifications**

ADDTK	AUTHL AUTHR	CBO	CCO	CFNTO	CFRMO	CND	EXBKL EXBKR	EXL EXR	FB	FFDL FFDR	FPEB
	•	•	•	•	•				•		•
ID	INVFRM	MIP	P	PFNBTAB	RD	TD	TAVR TVRFV TVRVV	WLI			
		•						•			

**Construction Upgrades**

APC	PE
•	•

**Door Options**

ALF	CG	CG.BTM	CG.TOP	DPSRR	MD	MD.BTM	MD.TOP	MFO
		•	•	•			•	•



**STACKED DIAGONAL WALL,  
48", 51", 54", 57", or 60" HIGH,  
24" x 24"**

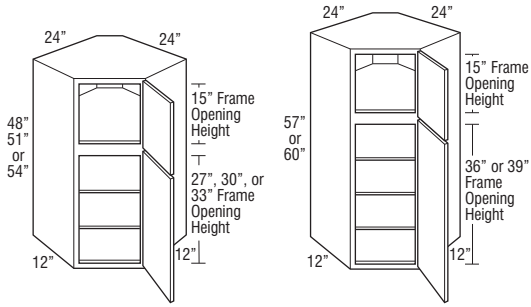

STDW482424 L or R  
STDW512424 L or R  
STDW542424 L or R

STDW572424 L or R  
STDW602424 L or R

Model	Cubic Feet
STDW482424 L or R	19.6
STDW512424 L or R	21.0
STDW542424 L or R	21.6
STDW572424 L or R	21.9
STDW602424 L or R	24.3

- Cabinet requires 24" x 24" of corner wall space.
- Bottom doors will always be square.
- Full overlay styles use HINGEQRP0, see page 429.

**Custom Modifications**

ADDTK	AUHL AUTHR	CBO	CCO	CFNTO	CFRMO	CND	EXBKL EXBKR	EXL EXR	FB	FFDL FFDR	FPFB
	•	•	•	•	•				•		•
ID	INVRM	MIP	P	PFINTMB	RD	TD	TVRAV TVRFV TVRVV	WLI			
•	•	•			•			•			

**Construction Upgrades**

APC	PE
•	•

**Door Options**

ALF	CG	CG.BTM	CG.TOP	DPSRR	MD	MD.BTM	MD.TOP	MFO
		•	•	•				•

**STACKED DIAGONAL WALL,  
48", 51", 54", 57", or 60" HIGH,  
27" x 27"**

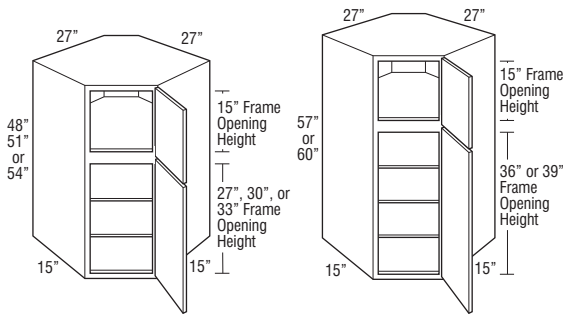

STDW482727 L or R  
STDW512727 L or R  
STDW542727 L or R

STDW572727 L or R  
STDW602727 L or R

STDW482727 L or R	23.4
STDW512727 L or R	26.1
STDW542727 L or R	24.1
STDW572727 L or R	26.4
STDW602727 L or R	29.3

- Cabinet requires 27" x 27" of corner wall space.
- Bottom doors will always be square.
- Full overlay styles use HINGEQRP0, see page 429.

**Custom Modifications**

ADDTK	AUHL AUTHR	CBO	CCO	CFNTO	CFRMO	CND	EXBKL EXBKR	EXL EXR	FB	FFDL FFDR	FPFB
	•	•	•	•	•				•		•
ID	INVRM	MIP	P	PFINTMB	RD	TD	TVRAV TVRFV TVRVV	WLI			
•	•	•			•			•			

**Construction Upgrades**

APC	PE
•	•

**Door Options**

ALF	CG	CG.BTM	CG.TOP	DPSRR	MD	MD.BTM	MD.TOP	MFO
		•	•	•				•

**DIAGONAL WALL PENINSULA,  
30", 33", 36", 39", or 42" HIGH,  
24" x 24 1/4"**

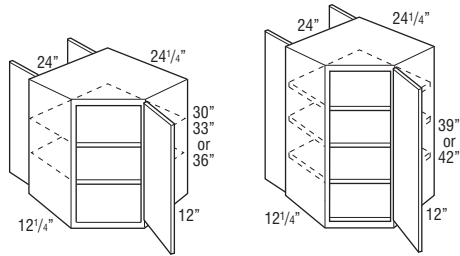

Model	Cubic Feet
DW302424PLL	12.5
DW302424PLR	12.5
DW302424PRL	12.5
DW302424PRR	12.5
DW332424PLL	13.9
DW332424PLR	13.9
DW332424PRL	13.9
DW332424PRR	13.9
DW362424PLL	14.9
DW362424PLR	14.9
DW362424PRL	14.9
DW362424PRR	14.9
DW392424PLL*	16.0
DW392424PLR*	16.0
DW392424PRL*	16.0
DW392424PRR*	16.0
DW422424PLL*	17.2
DW422424PLR*	17.2
DW422424PRL*	17.2
DW422424PRR*	17.2

- RL door hinging shown.
- Full overlay styles use HINGEQRPO, see page 429.
- \*When ordered with MD, shelves will not align with mullions.

**Custom Modifications**

ADDTK	AUTHL AUTHR	CBO	CCO	CFNTO	CFRMO	CND	EXBKL EXBKR	EXL EXR	FB	FFDL FFDR	FPFB
		•	•	•	•				•		•
ID	INVERM	MIP	P	PFINBTAB	RD	TD	TVRV TVRFV TVRVV	WLI			
		•	STD	•				•			

**Construction Upgrades**

APC	PE
•	•

**Door Options**

ALF	CG	CG.BTM	CG.TOP	DPSRR	MD	MD.BTM	MD.TOP	MFO
	•			•	•			•

**Diagonal Wall Peninsula**

Diagonals are different. All PLL, PLR, etc. designations refer to wall openings as well as hinge location. A PLL is left hinged on the kitchen (DW) side. Peninsula side is 24" wide and features butt doors. The second L or R in the product code indicates the position of the butt doors relative to the DW side.

**NOTE:**

All Peninsula wall cabinets must be fully supported by screwing into ceiling or soffit, and by screwing into adjoining cabinets. Weight load limit is 15 lbs. per square foot.

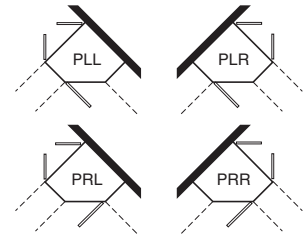

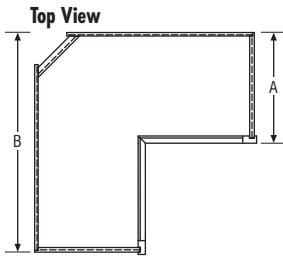

Easy Reach Wall Corner Cabinets with Increased or Reduced Depth

		RD9	RD10	RD11	STD	ID13	ID14	ID15	ID16	ID17	ID18	ID19	ID20	ID21	ID22	ID23	ID24
Cabinet Depth (ER_2424)	A	9"	10"	11"	12"	13"	14"	15"	16"	17"	18"	19"	20"	21"	22"	23"	24"
Wall Space (ER_2424)	B	21"	22"	23"	24"	25"	26"	27"	28"	29"	30"	31"	32"	33"	34"	35"	36"
Cabinet Depth (ER_2121)	A	9"	10"	11"	12"	13"	14"	15"	16"	17"	18"	19"	20"	21"	22"	23"	24"
Wall Space (ER_2121)	B	18"	19"	20"	21"	22"	23"	24"	25"	26"	27"	28"	29"	30"	31"	32"	33"

**EASY REACH WALL CORNER, 30", 33", 36", 39", or 42" HIGH, 21" x 21"**

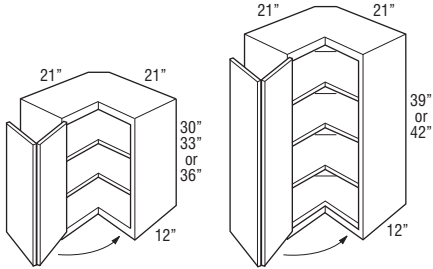

Model	Cubic Feet
ER302121 L or R	9.9
ER332121 L or R	10.3
ER362121 L or R	11.8
ER392121 L or R	12.7
ER422121 L or R	13.7

- Decorative hardware screws must be countersunk to prevent scratching of adjacent cabinets and face frame of ER.
- Adjustable shelves.
- Hinged door opens 170°.
- Integrated soft-close hinge not included.

Custom Modifications

	ADDTK	AUTHL AUTHR	CBO	CCO	CFNTO	CFRMO	CND	EXBKL EXBKR	EXL EXR	FB	FFDL FFDR	FPFB
		•	•	•						•		•
ID	INVERM	MIP	P	PFINTMB	RD	TD	TVRAV TVRFV TVRVV	WLI				
•		•		•	•			•				

Construction Upgrades

APC	PE
•	•

Door Options

ALF	CG	CG.BTM	CG.TOP	DPSRR	MD	MD.BTM	MD.TOP	MFO
				•				•

**EASY REACH WALL CORNER, 30", 33", 36", 39", or 42" HIGH, 24" x 24"**

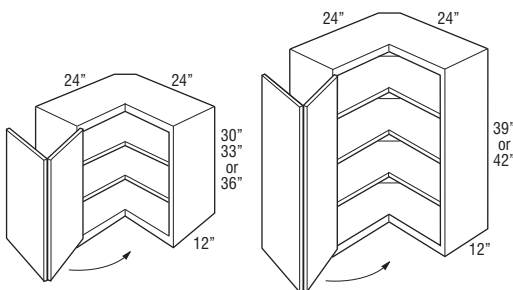

ER30 L or R	12.5
ER33 L or R	13.9
ER36 L or R	14.9
ER39 L or R	16.0
ER42 L or R	17.2

- Requires 24" x 24" of corner wall space.
- Decorative hardware screws must be countersunk to prevent scratching of adjacent cabinets and face frame of ER.
- Adjustable shelves.
- Hinged door opens 170°.
- Integrated soft-close hinge not included.

Custom Modifications

	ADDTK	AUTHL AUTHR	CBO	CCO	CFNTO	CFRMO	CND	EXBKL EXBKR	EXL EXR	FB	FFDL FFDR	FPFB
		•	•	•						•		•
ID	INVERM	MIP	P	PFINTMB	RD	TD	TVRAV TVRFV TVRVV	WLI				
•		•		•	•			•				

Construction Upgrades

APC	PE
•	•

Door Options

ALF	CG	CG.BTM	CG.TOP	DPSRR	MD	MD.BTM	MD.TOP	MFO
				•				•

**ASYMMETRICAL EASY REACH WALL  
CORNER, 30", 33", 36", 39", or  
42" HIGH**

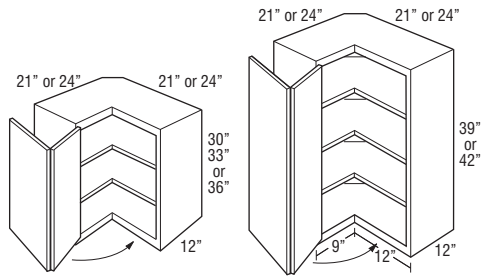

Model	Cubic Feet
ER302124 L or R	12.5
ER302421 L or R	12.5
ER332124 L or R	13.3
ER332421 L or R	13.3
ER362124 L or R	14.9
ER362421 L or R	14.9
ER392124 L or R	16.0
ER392421 L or R	16.0
ER422124 L or R	17.2
ER422421 L or R	17.2

- Hinged door opens to 170°.
- Adjustable shelves.
- Legs at the front frames are 9" on 21" leg and 12" on 24" leg.
- Nomenclature for asymmetrical cabinets reads as follows:  
First set of numbers = height  
Second set of numbers = left side  
Third set of numbers = right side
- Decorative hardware screws must be countersunk to prevent scratching of adjacent cabinets and face frame of ER.
- ER\_\_2124L shown.
- Integrated soft-close hinge not included.

**Custom Modifications**

ADDTK	AUTHL AUTHR	CBO	CCO	CFNTO	CFRMO	CND	EXBKL EXBKR	EXL EXR	FB	FFDL FFDR	FPFB
	•	•	•						•		•
ID	INVFRM	MIP	P	PFNBTAB	RD	TD	TVRAV TVRFV TVRVV	WLI			
•		•		•	•			•			

**Construction Upgrades**

APC	PE
•	•

**Door Options**

ALF	CG	CG.BTM	CG.TOP	DPSRR	MD	MD.BTM	MD.TOP	MFO
				•				•

**135° CORNER OUTSIDE WALL, 30", 33", or 36" HIGH**

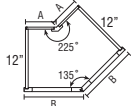
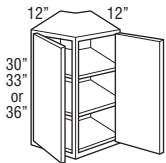

Model	A Dimension	B Dimension
W6(*)COA	6"	10 15/16"
W9(*)COA	9"	13 15/16"
W12(*)COA	12"	16 15/16"

A indicates back width of cabinet and wall space.  
 (\*) indicates height of cabinet.  
 B indicates face frame width.

Model	Cubic Feet
W630COA	8.0
W930COA	10.6
W1230COA	13.4
W633COA	8.8
W933COA	11.5
W1233COA	14.6
W636COA	9.5
W936COA	12.5
W1236COA	15.9

- Doors are hinged on outside of frame.
- Adjustable shelves cannot be removed from cabinet.

**Custom Modifications**

ADDTK	AUTHL AUTHR	CBO	CCO	CFNTO	CFRMO	CND	EXBKL EXBKR	EXL EXR	FB	FFDL FFDR	FPFB
		•	•						•		•
ID	INVERM	MIP	P	PFINBTMB	RD	TD	TVRAV TVRFV TVRVV	WLI			
		•		•				•			

**Construction Upgrades**

APC	PE
•	•

**Door Options**

ALF	CG	CG.BTM	CG.TOP	DPSRR	MD	MD.BTM	MD.TOP	MFO
	•			•				•

**135° CORNER OUTSIDE WALL, 39" or 42" HIGH**

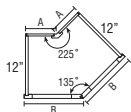
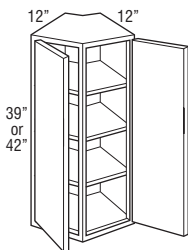

Model	A Dimension	B Dimension
W6(*)COA	6"	10 15/16"
W9(*)COA	9"	13 15/16"
W12(*)COA	12"	16 15/16"

A indicates back width of cabinet and wall space.  
 (\*) indicates height of cabinet.  
 B indicates face frame width.

W639COA	10.2
W939COA	13.5
W1239COA	17.1
W642COA	11.0
W942COA	14.4
W1242COA	18.3

- Doors are hinged on outside of frame.
- Adjustable shelves cannot be removed from cabinet.

**Custom Modifications**

ADDTK	AUTHL AUTHR	CBO	CCO	CFNTO	CFRMO	CND	EXBKL EXBKR	EXL EXR	FB	FFDL FFDR	FPFB
		•	•						•		•
ID	INVERM	MIP	P	PFINBTMB	RD	TD	TVRAV TVRFV TVRVV	WLI			
		•		•				•			

**Construction Upgrades**

APC	PE
•	•

**Door Options**

ALF	CG	CG.BTM	CG.TOP	DPSRR	MD	MD.BTM	MD.TOP	MFO
	•			•				•

**135° CORNER INSIDE WALL, 30", 33", or 36" HIGH**

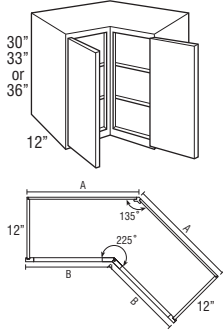

Model	A Dimension	B Dimension
W21(*)CIA	21"	16 1/16"
W24(*)CIA	24"	19 1/16"
W27(*)CIA	27"	22 1/16"

A indicates back width of cabinet and wall space.  
 (\*) indicates height of cabinet.  
 B indicates face frame width.

Model	Cubic Feet
W2130CIA	17.5
W2430CIA	20.8
W2730CIA	24.4
W2133CIA	19.1
W2433CIA	22.7
W2733CIA	26.6
W2136CIA	20.7
W2436CIA	24.6
W2736CIA	28.8

- Doors are hinged on outside of frame.
- Adjustable shelves cannot be removed from cabinet.

**Custom Modifications**

ADDTK	AUTHL AUTHR	CBO	CCO	CFNTO	CFRMO	CND	EXBKL EXBKR	EXL EXR	FB	FFDL FFDR	FPFB
		•	•						•		•
ID	INVFRM	MIP	P	PFNBTAB	RD	TD	TVRAV TVRFV TVRVV	WLI			
		•		•				•			

**Construction Upgrades**

APC	PE
•	•

**Door Options**

ALF	CG	CG.BTM	CG.TOP	DPSRR	MD	MD.BTM	MD.TOP	MFO
	•			•	•†			•

†Available only on W2430CIA, W2433CIA, and W2436CIA

**135° CORNER INSIDE WALL, 39" or 42" HIGH**

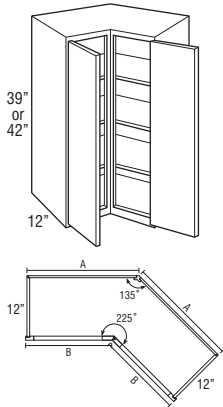

Model	A Dimension	B Dimension
W21(*)CIA	21"	16 1/16"
W24(*)CIA	24"	19 1/16"
W27(*)CIA	27"	22 1/16"

A indicates back width of cabinet and wall space.  
 (\*) indicates height of cabinet.  
 B indicates face frame width.

W2139CIA	22.2
W2439CIA	26.5
W2739CIA	31.1
W2142CIA	23.8
W2442CIA	28.4
W2742CIA	33.3

- Doors are hinged on outside of frame.
- Adjustable shelves cannot be removed from cabinet.

**Custom Modifications**

ADDTK	AUTHL AUTHR	CBO	CCO	CFNTO	CFRMO	CND	EXBKL EXBKR	EXL EXR	FB	FFDL FFDR	FPFB
			•	•					•		•
ID	INVFRM	MIP	P	PFNBTAB	RD	TD	TVRAV TVRFV TVRVV	WLI			
		•		•				•			

**Construction Upgrades**

APC	PE
•	•

**Door Options**

ALF	CG	CG.BTM	CG.TOP	DPSRR	MD	MD.BTM	MD.TOP	MFO
	•			•	•†			•

†Available only on W2439CIA and W2442CIA

**WALL END CABINET SINGLE DOOR,  
30", 33", 36", 39", or 42" HIGH,  
12" x 12"**

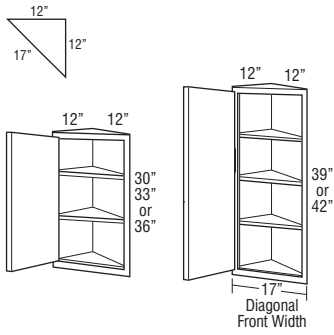

Model	Cubic Feet
WEC1230 L or R	3.7
WEC1233 L or R	4.1
WEC1236 L or R	4.4
WEC1239 L or R*	4.7
WEC1242 L or R*	4.9

- Width at wall: 12" x 12".
  - Cabinet features two unfinished back panels. Must be installed with one back panel adjacent to a cabinet of equal height with the other back panel attached to the wall.
- \*When ordered with MD, shelves will not align with mullions.

**Custom Modifications**

ADDTK	AUHL AUTHR	CBO	CCO	CFNTO	CFRMO	CND	EXBKL EXBKR	EXL EXR	FB	FFDL FFDR	FPFB
		•	•	•	•						
ID	INVERM	MIP	P	PFINBTMB	RD	TD	TVRAV TVRFV TVRVV	WLI			
		•		•				•			

**Construction Upgrades**

APC	PE
•	

**Door Options**

ALF	CG	CG.BTM	CG.TOP	DPSRR	MD	MD.BTM	MD.TOP	MFO
	•			•	•			•

**STACKED WALL END CABINET SINGLE  
DOOR, 48", 51", 54", 57", or 60"  
HIGH, 12" x 12"**

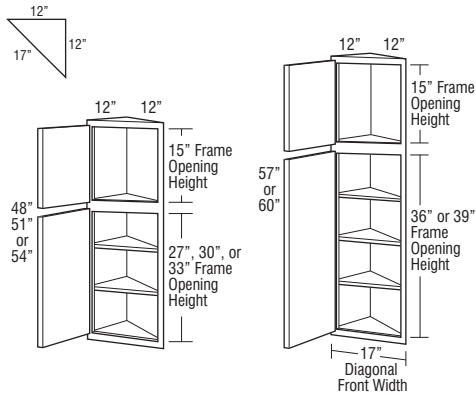

STWEC1248 L or R	5.7
STWEC1251 L or R	6.0
STWEC1254 L or R	6.4
STWEC1257 L or R	6.7
STWEC1260 L or R	7.0

- Width at wall: 12" x 12".
- Cabinet features two unfinished back panels. Must be installed with one back panel adjacent to a cabinet of equal height with the other back panel attached to the wall.

**Custom Modifications**

ADDTK	AUHL AUTHR	CBO	CCO	CFNTO	CFRMO	CND	EXBKL EXBKR	EXL EXR	FB	FFDL FFDR	FPFB
		•	•	•	•				STD		
ID	INVERM	MIP	P	PFINBTMB	RD	TD	TVRAV TVRFV TVRVV	WLI			
	•	•						•			

**Construction Upgrades**

APC	PE
•	

**Door Options**

ALF	CG	CG.BTM	CG.TOP	DPSRR	MD	MD.BTM	MD.TOP	MFO
		•	•	•				•

**WALL END CABINET DOUBLE DOOR,  
30", 33", 36", 39", or 42" HIGH,  
12" x 12"**

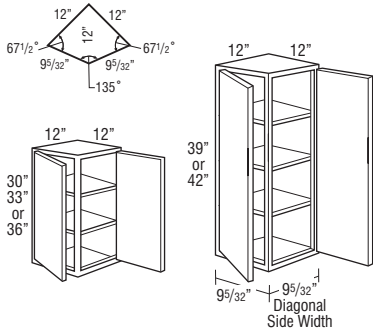

Model	Cubic Feet
WEC1230D	3.7
WEC1233D	4.1
WEC1236D	4.4
WEC1239D	4.7
WEC1242D	4.9

- Width at wall: 12" x 12".
- Cabinet features two unfinished back panels. Must be installed with one back panel adjacent to a cabinet of equal height with the other back panel attached to the wall.
- Decorative glass inserts are not available.

**Custom Modifications**

ADDTK	AUTHL AUTHR	CBO	CCO	CFNTO	CFRMO	CND	EXBKL EXBKR	EXL EXR	FB	FFDL FFDR	FPEB
		•	•								
ID	INVFRM	MIP	P	PFNBTAB	RD	TD	TVRAV TVRFV TVRVV	WLI			
		•		•				•			

**Construction Upgrades**

APC	PE
•	

**Door Options**

ALF	CG	CG.BTM	CG.TOP	DPSRR	MD	MD.BTM	MD.TOP	MFO
	•			•				•

**STACKED WALL END CABINET DOUBLE  
DOOR, 48", 51", 54", 57", or 60"  
HIGH, 12" x 12"**

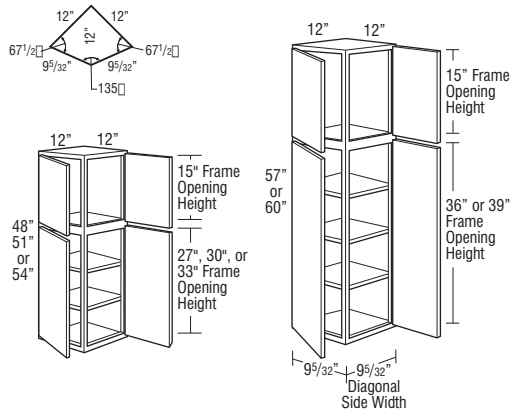

STWEC1248D	5.7
STWEC1251D	6.0
STWEC1254D	6.4
STWEC1257D	6.7
STWEC1260D	7.0

- Width at wall: 12" x 12".
- Cabinet features two unfinished back panels. Must be installed with one back panel adjacent to a cabinet of equal height with the other back panel attached to the wall.
- Decorative glass inserts are not available.

**Custom Modifications**

ADDTK	AUTHL AUTHR	CBO	CCO	CFNTO	CFRMO	CND	EXBKL EXBKR	EXL EXR	FB	FFDL FFDR	FPEB
		•	•						STD		
ID	INVFRM	MIP	P	PFNBTAB	RD	TD	TVRAV TVRFV TVRVV	WLI			
	•	•						•			

**Construction Upgrades**

APC	PE
•	

**Door Options**

ALF	CG	CG.BTM	CG.TOP	DPSRR	MD	MD.BTM	MD.TOP	MFO
		•	•	•				•



**WALL QUARTER ROUND END SHELF,  
30", 33", 36", 39", or 42" HIGH**

**Radius Top and Bottom Panels**

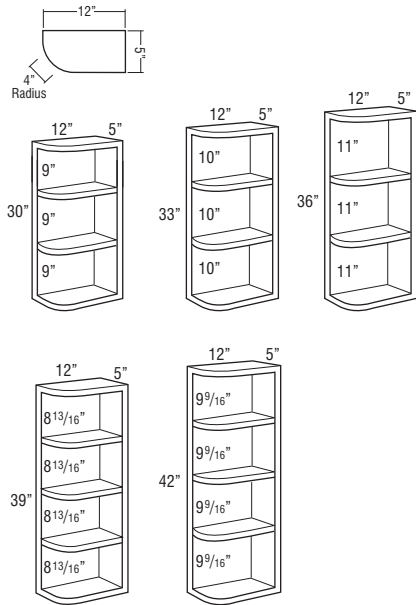

**Square Top and Radius Bottom Panels**

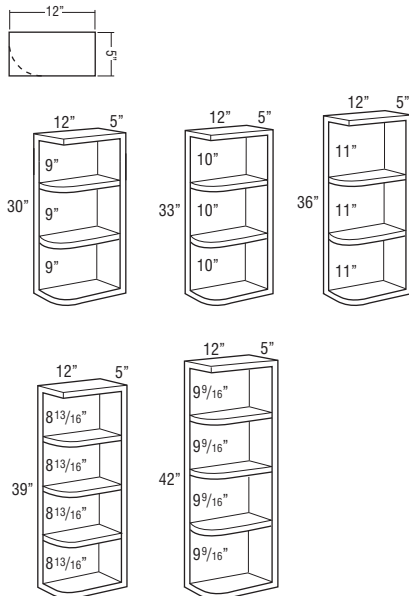

**Square Top and Bottom Panels**

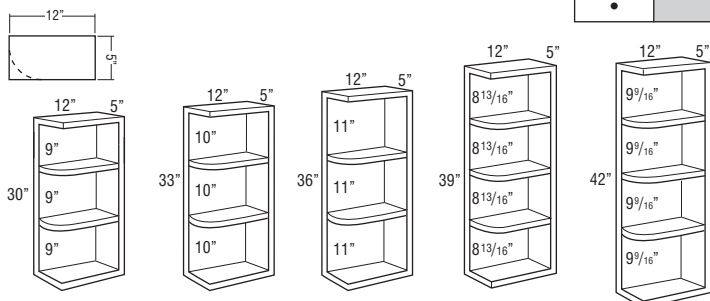

Model	Cubic Feet
WQRES630RT	1.8
WQRES633RT	1.9
WQRES636RT	2.2
WQRES639RT	2.5
WQRES642RT	2.9

- Units are reversible.
- 12" deep x 5" wide, 4" shelf radius.
- Radius moulding is not available for WQRES636RT.
- Veneer on 3/4" furniture board core.
- Matching interior.
- Veneer construction, finished to match cabinet face frame.
- If ordered with Heirloom Technique, will not feature sand-through characteristics.
- Cabinet features two unfinished back panels. Must be installed with one back panel adjacent to a cabinet of equal height with the other back panel attached to the wall.

WQRES630ST L or R	1.8
WQRES633ST L or R	2.3
WQRES636ST L or R	2.5
WQRES639ST L or R	2.5
WQRES642ST L or R	2.9

- Specify left or right. Only top panel is square. Right shown.
- Veneer on 3/4" furniture board core.
- Matching interior.
- Veneer construction, finished to match cabinet face frame.
- If ordered with Heirloom Technique, will not feature sand-through characteristics.
- Cabinet features two unfinished back panels. Must be installed with one back panel adjacent to a cabinet of equal height with the other back panel attached to the wall.

WQRES630STSB	1.8
WQRES633STSB	1.9
WQRES636STSB	2.2
WQRES639STSB	2.5
WQRES642STSB	2.9

- Units are reversible.
- Veneer on 3/4" furniture board core.
- Matching interior.
- Veneer construction, finished to match cabinet face frame.
- If ordered with Heirloom Technique, will not feature sand-through characteristics.
- Cabinet features two unfinished back panels. Must be installed with one back panel adjacent to a cabinet of equal height with the other back panel attached to the wall.

**MODIFICATIONS**

No modifications available for these products.

**Construction Upgrades**

APC	PE
•	

**WALL QUARTER ROUND END SHELF,  
12" RADIUS, 30", 33", 36", 39", or  
42" HIGH**

**Radius Top and Bottom Panels**

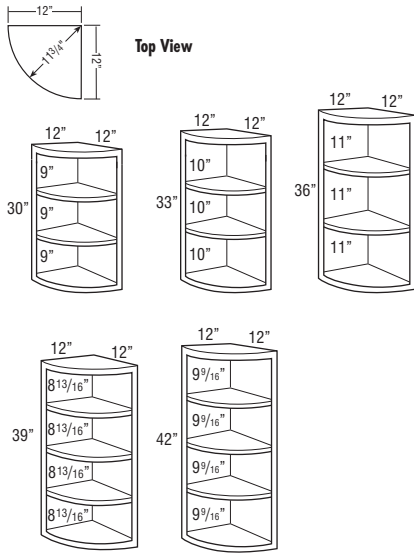

**Square Top and Radius Bottom Panels**

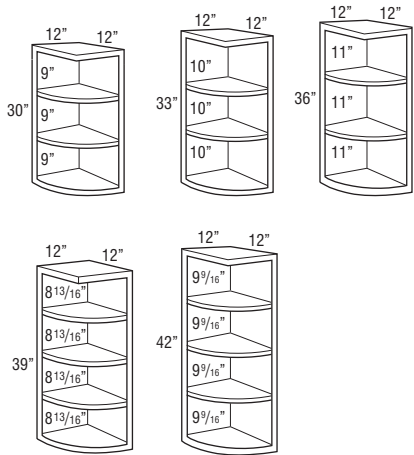

**Square Top and Bottom Panels**

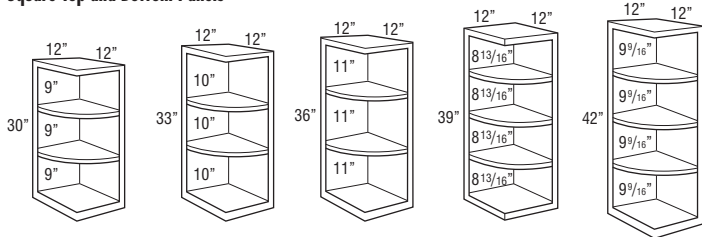

Model	Cubic Feet
<b>WQRES1230RT</b>	3.7
<b>WQRES1233RT</b>	4.0
<b>WQRES1236RT</b>	4.4
<b>WQRES1239RT</b>	4.7
<b>WQRES1242RT</b>	5.1
<ul style="list-style-type: none"> <li>• Veneer on 3/4" furniture board core.</li> <li>• Matching interior.</li> <li>• Veneer construction, finished to match cabinet face frame.</li> <li>• If ordered with Heirloom Technique, will not feature sand-through characteristics.</li> <li>• Cabinet features two unfinished back panels. Must be installed with one back panel adjacent to a cabinet of equal height with the other back panel attached to the wall.</li> </ul>	
<b>WQRES1230STRB</b>	3.7
<b>WQRES1233STRB</b>	4.0
<b>WQRES1236STRB</b>	4.4
<b>WQRES1239STRB</b>	4.7
<b>WQRES1242STRB</b>	5.1
<ul style="list-style-type: none"> <li>• Veneer on 3/4" furniture board core.</li> <li>• Matching interior.</li> <li>• Veneer construction, finished to match cabinet face frame.</li> <li>• If ordered with Heirloom Technique, will not feature sand-through characteristics.</li> <li>• Cabinet features two unfinished back panels. Must be installed with one back panel adjacent to a cabinet of equal height with the other back panel attached to the wall.</li> </ul>	
<b>WQRES1230STSB</b>	3.7
<b>WQRES1233STSB</b>	4.0
<b>WQRES1236STSB</b>	4.4
<b>WQRES1239STSB</b>	4.7
<b>WQRES1242STSB</b>	5.1

MODIFICATIONS	
No modifications available for these products.	

**Construction Upgrades**

APC	PE
•	

**WALL TRANSITION CABINET, 30",  
33", 36", 39", or 42" HIGH**

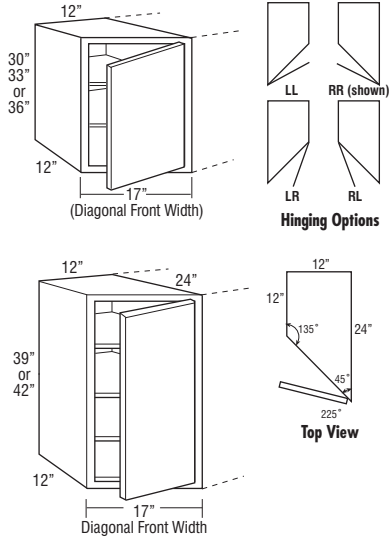

Model	Cubic Feet
WTC1230LL	6.9
WTC1230RL	6.9
WTC1230LR	6.9
WTC1230RR	6.9
WTC1233LL	7.6
WTC1233RL	7.6
WTC1233LR	7.6
WTC1233RR	7.6
WTC1236LL	8.1
WTC1236RL	8.1
WTC1236LR	8.1
WTC1236RR	8.1
WTC1239LL	8.7
WTC1239RL	8.7
WTC1239LR	8.7
WTC1239RR	8.7
WTC1242LL	9.4
WTC1242RL	9.4
WTC1242LR	9.4
WTC1242RR	9.4

- Specify door hinging. RR shown.
- Depth can be reduced to a minimum of 18".
- Full overlay styles use the same width doors as partial overlay styles (14 1/2" wide) with a partial overlay hinge (38NPOHINGE) to allow for proper door clearance with adjacent cabinets.

**Custom Modifications**

ADDTK	AUTHL AUTHR	CBO	CCO	CFNT0	CFRMO	CND	EXBKL EXBKR	EXL EXR	FB	FFDL FFDR	FPFB
	•*	•	•	•	•				•	•*	•*
ID	INVERM	MIP	P	PFINBTMB	RD	TD	TVRAV TVRFV TVRVV	WLI			
		•		•	•			•			

\*Available only on 12" deep side of cabinet

**Construction Upgrades**

APC	PE
•	•

**Door Options**

ALF	CG	CG.BTM	CG.TOP	DPSRR	MD	MD.BTM	MD.TOP	MFO
	•			•	•			•

**STACKED WALL TRANSITION CABINET,  
48", 51", 54", 57", or 60" HIGH**

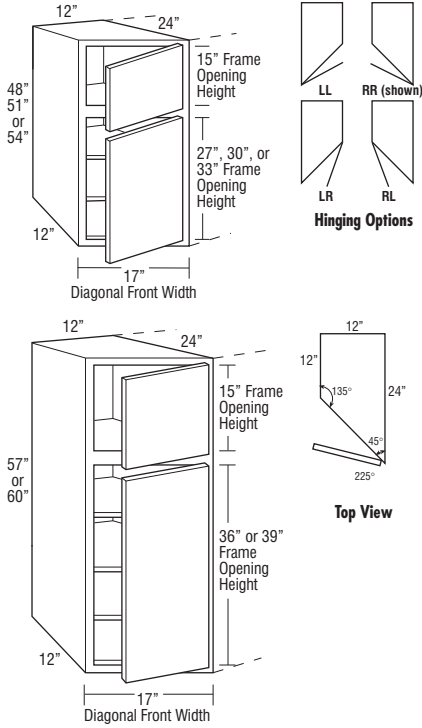

Model	Cubic Feet
STWTC1248LL	5.7
STWTC1248RL	5.7
STWTC1248LR	5.7
STWTC1248RR	5.7
STWTC1251LL	6.0
STWTC1251RL	6.0
STWTC1251LR	6.0
STWTC1251RR	6.0
STWTC1254LL	6.4
STWTC1254RL	6.4
STWTC1254LR	6.4
STWTC1254RR	6.4
STWTC1257LL	6.7
STWTC1257RL	6.7
STWTC1257LR	6.7
STWTC1257RR	6.7
STWTC1260LL	7.0
STWTC1260RL	7.0
STWTC1260LR	7.0
STWTC1260RR	7.0

- Specify door hinging. RR shown.
- Depth can be reduced to a minimum of 18".
- Full overlay styles use the same width doors as partial overlay styles (14 1/2" wide) with a partial overlay hinge (38NPOHINGE) to allow for proper door clearance with adjacent cabinets.

**Custom Modifications**

ADDTK	AUTHL AUTHR	CBO	CCO	CFNTO	CFRMO	CND	EXBKL EXBKR	EXL EXR	FB	FFDL FFDR	FPEB
	•*	•	•	•	•				STD	•*	•*
ID	INVFRM	MIP	P	PFNBMTB	RD	TD	TVRAV TVRFV TVRVV	WLI			
	•	•			•			•			

\*Available only on 12" deep side of cabinet

**Construction Upgrades**

APC	PE
•	•

**Door Options**

ALF	CG	CG.BTM	CG.TOP	DPSRR	MD	MD.BTM	MD.TOP	MFO
		•	•	•				•

## WALL MICROWAVE CABINET, 18" or 21" HIGH

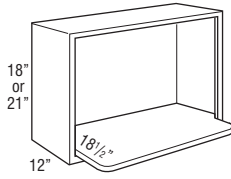

**MW2718**  
Opening: 24" w x 14 1/4" h  
Cabinet: 27" w x 18" h

**MW3018**  
Opening: 27" w x 14 1/4" h  
Cabinet: 30" w x 18" h

**MW2721**  
Opening: 24" w x 17 1/4" h  
Cabinet: 27" w x 21" h

**MW3021**  
Opening: 27" w x 17 1/4" h  
Cabinet: 30" w x 21" h

Model	Cubic Feet
<b>MW2718</b>	4.6
<b>MW3018</b>	6.9
<b>MW2721</b>	5.4
<b>MW3021</b>	8.0

- Includes one 3/4" shelf with six mounting screws. Microwave shelf extends beyond the front of the cabinet by 6 1/2", for a total shelf depth of 18 1/2".
- Microwave cabinet must be attached to wall stud and adjacent cabinets on both sides for support.
- Matching Interior Plywood (MIP) standard.
- When ID is ordered, shelf will not be included with cabinet.
- If ordered with Heirlooming Technique, will not feature sand-through characteristics.

### Custom Modifications

ADDTK	AUTHL AUTHR	CBO	CCO	CFNTO	CFRMO	CND	EXBKL EXBKR	EXL EXR	FB	FFDL FFDR	FPEB
	•	STD			•		•	•			•
ID	INVERM	MIP	P	PFINBTMB	RD	TD	TAVR TVRFV TVRVV	WLI			
•		STD		•							

### Construction Upgrades

APC	PE

### Door Options

ALF	CG	CG.BTM	CG.TOP	DPSRR	MD	MD.BTM	MD.TOP	MFO

## WALL MICROWAVE DOUBLE DOOR CABINET, 36" HIGH

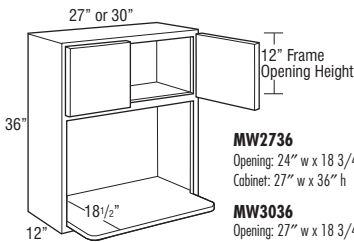

**MW2736**  
Opening: 24" w x 18 3/4" h  
Cabinet: 27" w x 36" h

**MW3036**  
Opening: 27" w x 18 3/4" h  
Cabinet: 30" w x 36" h

<b>MW2736</b>	6.8
<b>MW3036</b>	10.0

- Includes one 3/4" shelf with six mounting screws. Microwave shelf extends beyond the front of the cabinet by 6 1/2", for a total shelf depth of 18 1/2".
- Microwave cabinet must be attached to wall stud and adjacent cabinets on both sides for support.
- Matching Interior Plywood (MIP) standard.
- When ID is ordered, shelf will not be included with cabinet.

### Custom Modifications

ADDTK	AUTHL AUTHR	CBO	CCO	CFNTO	CFRMO	CND	EXBKL EXBKR	EXL EXR	FB	FFDL FFDR	FPEB
	•	•	•	•	•		•	•			•
ID	INVERM	MIP	P	PFINBTMB	RD	TD	TAVR TVRFV TVRVV	WLI			
•		STD		•							

### Construction Upgrades

APC	PE

### Door Options

ALF	CG	CG.BTM	CG.TOP	DPSRR	MD	MD.BTM	MD.TOP	MFO
	•			•				•

**WALL BUILT-IN MICROWAVE CABINET,  
18" or 21" HIGH**

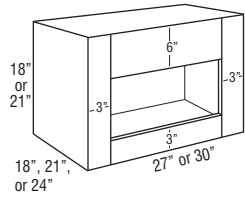

Model	Factory Opening	Maximum Cut-out
2718	21W x 9H	25 1/2W x 15H
2721	21W x 12H	25 1/2W x 18H
3018	24W x 9H	28 1/2W x 15H
3021	24W x 12H	28 1/2W x 18H

Model	Cubic Feet
<b>WBMW271818</b>	4.6
<b>WBMW301818</b>	6.9
<b>WBMW272118</b>	5.4
<b>WBMW302118</b>	8.0
<b>WBMW271821</b>	6.8
<b>WBMW301821</b>	8.2
<b>WBMW272121</b>	8.4
<b>WBMW302121</b>	9.5
<b>WBMW271824</b>	8.5
<b>WBMW301824</b>	9.4
<b>WBMW272124</b>	9.8
<b>WBMW302124</b>	10.9

- WBMWs can be used to stack with other cabinets to create custom appliance cabinet designs.
- Microwave cabinet must be attached to wall stud and adjacent cabinets on both sides for support.
- If ordered with Heirlooming Technique, will not feature sand-through characteristics.

**Custom Modifications**

ADDTK	AUTHL AUTHR	CBO	CCO	CFNTO	CFRMO	CND	EXBKL EXBKR	EXL EXR	FB	FFDL FFDR	FPEB
	•	STD			•		•	•	•		•
ID	INVFRM	MIP	P	PFNBMB	RD	TD	TVRAV TVRFV TVRVV	WLI			
•		•		•	•			•			

**Construction Upgrades**

APC	PE
•	•

**Door Options**

ALF	CG	CG.BTM	CG.TOP	DPSRR	MD	MD.BTM	MD.TOP	MFO

**WALL BUILT-IN MICROWAVE DOUBLE DOOR CABINET, 36", 39", or 42" HIGH, 18" or 21" DEEP**

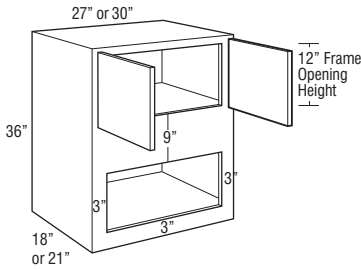

**WBMW273618 WBMW273621**  
**WBMW303618 WBMW303621**

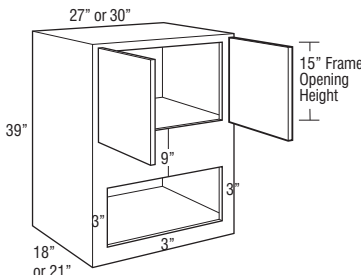

**WBMW273918 WBMW273921**  
**WBMW303918 WBMW303921**

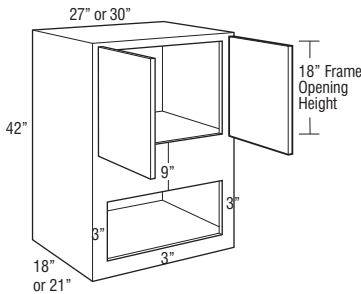

**WBMW274218 WBMW274221**  
**WBMW304218 WBMW304221**

Model	Factory Opening	Maximum Cut-out
2736	21W x 10 1/2H	25 1/2W x 19 3/4H
2739	21W x 10 1/2H	25 1/2W x 19 3/4H
2742	21W x 10 1/2H	25 1/2W x 19 3/4H
3036	24W x 10 1/2H	28 1/2W x 19 3/4H
3039	24W x 10 1/2H	28 1/2W x 19 3/4H
3042	24W x 10 1/2H	28 1/2W x 19 3/4H

Model	Cubic Feet
<b>WBMW273618</b>	12.1
<b>WBMW303618</b>	13.3
<b>WBMW273918</b>	13.5
<b>WBMW303918</b>	14.9
<b>WBMW274218</b>	14.0
<b>WBMW304218</b>	15.5
<b>WBMW273621</b>	11.4
<b>WBMW303621</b>	15.8
<b>WBMW273921</b>	15.0
<b>WBMW303921</b>	18.4
<b>WBMW274221</b>	13.2
<b>WBMW304221</b>	17.1

- Two 1/4" fillers included, except with FPFB, AUTHL, and AUTHR.
- Microwave cabinet must be attached to wall stud and adjacent cabinets on both sides for support.
- All cabinets have 3" stiles on frames.
- When CG is specified, face frame will be visible through door if used with a translucent art or textured glass design.
- Uses face mount hinges on all styles.

**Custom Modifications**

ADDTK	AUTHL AUTHR	CBO	CCO	CFNTO	CFRMO	CND	EXBKL EXBKR	EXL EXR	FB	FFDL FFDR	FPFB
	•		•		•		•	•	•		•
ID	INVERM	MIP	P	PFINGTAB	RD	TD	TAVAV TVRFV TVRVV	WLI			
•		•		•	•			•			

**Construction Upgrades**

APC	PE
•	•

**Door Options**

ALF	CG	CG.BTM	CG.TOP	DPSRR	MD	MD.BTM	MD.TOP	MFO
	•			•				•

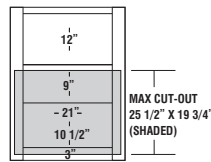

**WBMW273618**  
**WBMW273621**

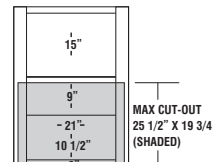

**WBMW273918**  
**WBMW273921**

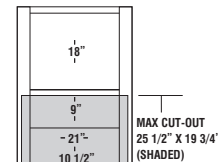

**WBMW274218**  
**WBMW274221**

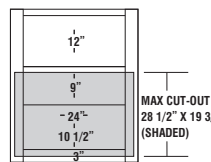

**WBMW303618**  
**WBMW303621**

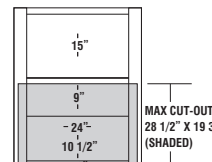

**WBMW303918**  
**WBMW303921**

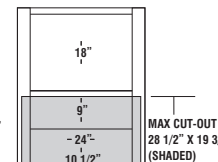

**WBMW304218**  
**WBMW304221**

**STRAIGHT TAMBOUR,  
18" HIGH, 12" DEEP**

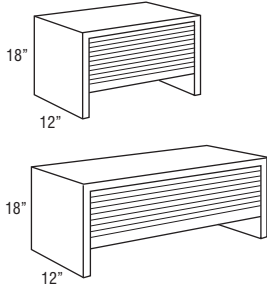

Model	Cubic Feet
ST18	3.3
ST21	3.8
ST24	4.3
ST27	4.8
ST30	5.3
ST33	5.8
ST36	6.3

- Cabinet has back and top.
- If ordered with Heirloom Technique, will not feature sand-through characteristics.
- Trim height will be restricted when AUTHL or AUTHR is selected.

**Custom Modifications**

ADDTK	AUTHL AUTHR	CBO	CCO	CFNTO	CFRMO	CND	EXBKL EXBKR	EXL EXR	FB	FFDL FFDR	FPEB
	•	•	•		•		•	•	•		•
ID	INVFRM	MIP	P	PFNBAMB	RD	TD	TVRAV TVRFV TVRVV	WLI			
•		•			•			•			

**Construction Upgrades**

APC	PE
•	•

**Door Options**

ALF	CG	CG.BTM	CG.TOP	DPSRR	MD	MD.BTM	MD.TOP	MFO

**WALL APPLIANCE GARAGE DOOR,  
18" HIGH, 12" DEEP**

12", 15", 18", 21", or 24"

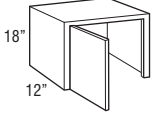

24", 27", 30", 33", or 36"

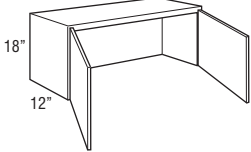

WAGD12 L or R	2.3
WAGD15 L or R	2.8
WAGD18 L or R	3.3
WAGD21 L or R	3.8
WAGD24 L or R	4.3
WAGD24	4.3
WAGD27	4.7
WAGD30	5.2
WAGD33	5.7
WAGD36	6.2

- Cabinet does not have floor.
- When ordered in Arch door styles, door will be Square.

**Custom Modifications**

ADDTK	AUTHL AUTHR	CBO	CCO	CFNTO	CFRMO	CND	EXBKL EXBKR	EXL EXR	FB	FFDL FFDR	FPEB
	•		•	•	•		•	•	STD		•
ID	INVFRM	MIP	P	PFNBAMB	RD	TD	TVRAV TVRFV TVRVV	WLI			
•		•			•			•			

**Construction Upgrades**

APC	PE
•	STD

**Door Options**

ALF	CG	CG.BTM	CG.TOP	DPSRR	MD	MD.BTM	MD.TOP	MFO
	•			•				



**WALL APPLIANCE GARAGE  
VERTICAL-LIFT DOOR,  
18" HIGH, 12" DEEP**

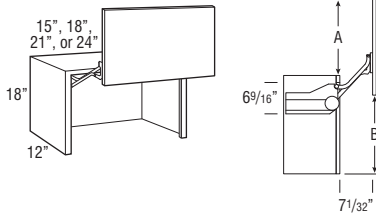

	Full Overlay	Partial Overlay
A	16 13/16"	16 1/16"
B	17 5/16"	18 1/16"

Model	Cubic Feet
WAGVLD15	2.8
WAGVLD18	3.3
WAGVLD21	3.8
WAGVLD24	4.3

- Utilizes standard doors with vertical grain on center panel and standard door configuration. Granite will have standard vertical grain pattern. Tranter will have standard horizontal grain pattern.
- When ordered in Arch door styles, door will be Square.
- Decorative hardware required.
- See side view drawing for required clearances.
- Lift mechanism features a single motion for up and out movement with Smart Stop, tension can be field adjusted.
- Lift mechanisms and mounting brackets will be visible if used with transparent textured glass.
- Lift mechanism not available for order for field installation, only available factory installed.
- Hardware extends 1" into opening on each side.
- Bottom edge not trimmable.

**Custom Modifications**

ADDTK	AUTHL AUTHR	CBO	CCO	CFNTD	CFRMO	CND	EXBKL EXBKR	EXL EXR	FB	FFDL FFDR	FPEB
	•		•		•		•	•	•		•
ID	INVFRM	MIP	P	PFINTMB	RD	TD	TVRAV TVRFV TVRVV	WLI			
•		•						•			

**Construction Upgrades**

APC	PE
•	•

**Door Options**

ALF	CG	CG.BTM	CG.TOP	DPSRR	MD	MD.BTM	MD.TOP	MFO
	•			•				

**CORNER TAMBOUR, 18" HIGH**

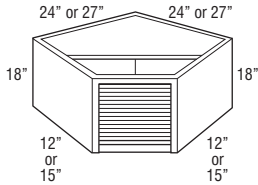

Model	Cubic Feet
CT2424	7.8
CT2727	8.3

- CT2424 requires 24" x 24" corner wall space.
- CT2727 requires 27" x 27" corner wall space.
- Cabinet is designed to fit beneath Diagonal Wall Cabinets.
- Cabinet has partial top and no floor.
- If ordered with Heirlooming Technique, will not feature sand-through characteristics.
- Trim height will be restricted when AUTHL or AUTHR is selected.

**Custom Modifications**

ADDTK	AUTHL AUTHR	CBO	CCO	CFNTD	CFRMO	CND	EXBKL EXBKR	EXL EXR	FB	FFDL FFDR	FPEB
	•	•	•		•				•		•
ID	INVFRM	MIP	P	PFINTMB	RD	TD	TVRAV TVRFV TVRVV	WLI			
		•						•			

**Construction Upgrades**

APC	PE
•	•

**Door Options**

ALF	CG	CG.BTM	CG.TOP	DPSRR	MD	MD.BTM	MD.TOP	MFO

**CORNER DOOR, 18" HIGH**

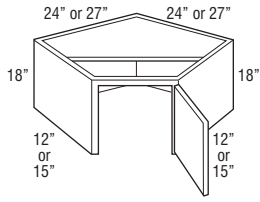

Model	Cubic Feet
CD2424 L or R	7.8
CD2727 L or R	8.3

- CD2424 L or R requires 24" x 24" corner wall space.
- CD2727 L or R requires 27" x 27" corner wall space.
- Cabinet is designed to fit beneath Diagonal Wall Cabinets.
- When ordered in Arch door styles, door will be Square.
- Cabinet has partial top and no floor.
- Full overlay styles use the same width doors as partial overlay styles (14 1/2" wide) with a partial overlay hinge (38NPOHINGE) to allow for proper door clearance with adjacent cabinets.

**Custom Modifications**

	AUTHL AUTHR	CBO	CCO	CFNT0	CFRMO	CND	EXBKL EXBKR	EXL EXR	FB	FFDL FFDR	FPEB
	•		•	•	•				•		•
ID	INVERM	MIP	P	PFINBTAB	RD	TD	TGRAV TVRFV TVRVV	WLI			
		•						•			

**Construction Upgrades**

APC	PE
•	•

**Door Options**

ALF	CG	CG.BTM	CG.TOP	DPSRR	MD	MD.BTM	MD.TOP	MFO
	•			•				

**WALL BOX COLUMN PULL-OUT, PLAIN LOGIX**

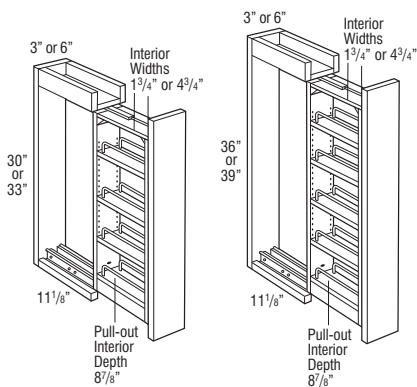

WBCPO\_30  
WBCPO\_33

WBCPO\_36  
WBCPO\_39

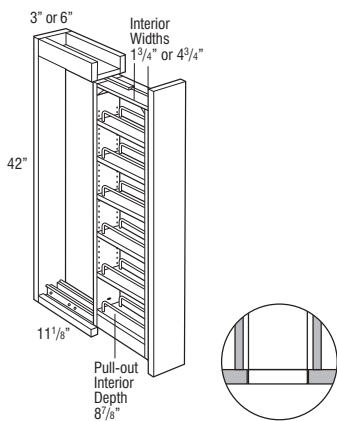

WBCPO\_42

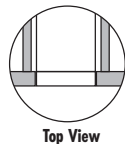

WBCPO330	0.6
WBCPO333	1.3
WBCPO336	1.4
WBCPO339	1.5
WBCPO342	1.6
WBCPO630	1.3
WBCPO633	2.2
WBCPO636	2.4
WBCPO639	2.6
WBCPO642	2.7

- Recommend installation between two cabinets. Can be installed on the end of a run or adjacent to an appliance with a 3/4" thick end panel.
- All styles feature a natural finish full extension wood pull-out with adjustable shelves and chrome rail sides.
- If ordered with Heirloom Technique, will not feature sand-through characteristics.
- In order to allow proper clearance for opening and closing, allow an additional 1/8" space between adjacent cabinet face frames. The 3" wide pull-outs require 3 1/8" space and the 6" wide pull-outs require 6 1/8" space. Spacers are included with the pull-outs to allow for proper installation.
- For full access from both sides of unit, do not install against a wall or next to deeper appliances and cabinets.

**MODIFICATIONS**

No modifications available for these products.

**Finish Techniques**

Distressing	Heirlooming
•	

## WALL BOX COLUMN PULL-OUT, OVERLAY

L G I X

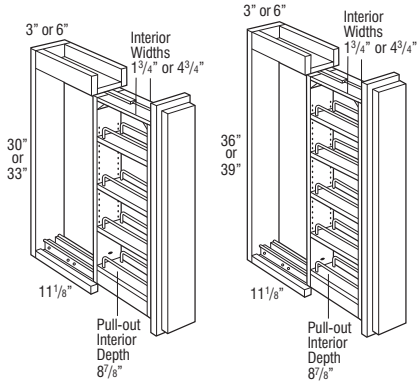

WBCPO\_300L  
WBCPO\_330L

WBCPO\_360L  
WBCPO\_390L

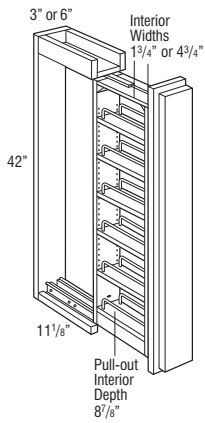

WBCPO\_420L

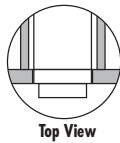

Model	Cubic Feet
WBCPO3300L	0.6
WBCPO3330L	1.3
WBCPO3360L	1.4
WBCPO3390L	1.5
WBCPO3420L	1.6
WBCPO6300L	1.3
WBCPO6330L	2.2
WBCPO6360L	2.4
WBCPO6390L	2.6
WBCPO6420L	2.7

- Recommend installation between two cabinets. Can be installed on the end of a run or adjacent to an appliance with a 3/4" thick end panel.
- Overlay application includes profiled full overlay filler.
- All styles feature a natural finish full extension wood pull-out with adjustable shelves and chrome rail sides.
- In order to allow proper clearance for opening and closing, allow an additional 1/8" space between adjacent cabinet face frames. The 3" wide pull-outs require 3 1/8" space and the 6" wide pull-outs require 6 1/8" space. Spacers are included with the pull-outs to allow for proper installation.
- For full access from both sides of unit, do not install against a wall or next to deeper appliances and cabinets.
- Not compatible with face mount moulding.

### MODIFICATIONS

No modifications available for these products.

### Finish Techniques

Distressing	Heirlooming
•	•

**WALL BOX COLUMN PULL-OUT with K-CUP\*, PLAIN**

L O G I X

Model	Cubic Feet
WBCPOKCUP330	1.2
WBCPOKCUP333	1.3
WBCPOKCUP336	1.4
WBCPOKCUP339	1.5
WBCPOKCUP342	1.6

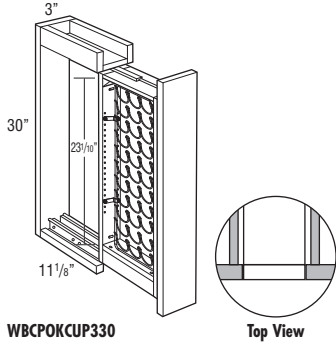

WBCPOKCUP330

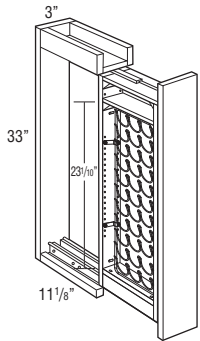

WBCPOKCUP333

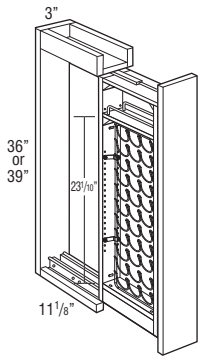

WBCPOKCUP336  
WBCPOKCUP339

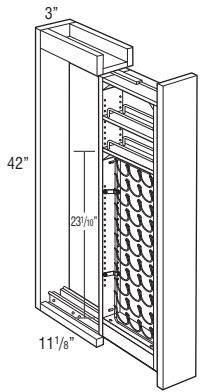

WBCPOKCUP342

- Holds 44 K-Cups, compatible with K-Cup pods only.
  - Wire K-Cup rack included for easy field installation on either the left or right side (K-Cups are only accessible from one side). All units include adjustable shelves with chrome rail sides that can be used for future installation if K-Cup insert is no longer desired. Depending on height of pull-out, shelves can be used above or below insert for additional storage:  
30" & 33" high include 4 shelves, not compatible with insert.  
36" & 39" high include 5 shelves, one shelf recommended for use with insert.  
42" high includes 6 shelves, two shelves recommended for use with insert.
  - Recommend installation between two cabinets. Can be installed on the end of a run or adjacent to an appliance with a 3/4" thick end panel.
  - All styles feature a natural finish full extension wood pull-out.
  - In order to allow proper clearance for opening and closing, allow an additional 1/8" space between adjacent cabinet face frames. The 3" wide pull-outs require 3 1/8" space. Spacers are included with the pull-outs to allow for proper installation.
  - For full access of upper shelves from both sides of unit, do not install against a wall or next to deeper appliances and cabinets.
  - Finger pull routed on bottom edge of wall unit. Hardware optional.
  - Pull-out does not have Smart Stop feature.
- \*K-Cup is a registered trademark of Keurig Green Mountain, Inc.

MODIFICATIONS
No modifications available for these products.

**Finish Techniques**

Distressing	Heirlooming
•	

**WALL BOX COLUMN PULL-OUT with K-CUP\*, OVERLAY**

L G I X

Model	Cubic Feet
WBCPOKCUP3300L	1.2
WBCPOKCUP3330L	1.3
WBCPOKCUP3360L	1.4
WBCPOKCUP3390L	1.5
WBCPOKCUP3420L	1.6

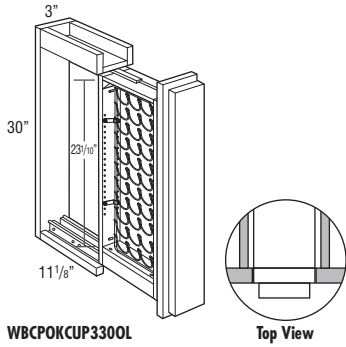

WBCPOKCUP3300L

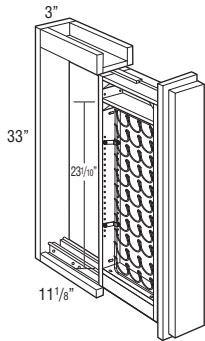

WBCPOKCUP3330L

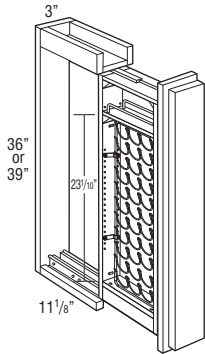

WBCPOKCUP3360L  
WBCPOKCUP3390L

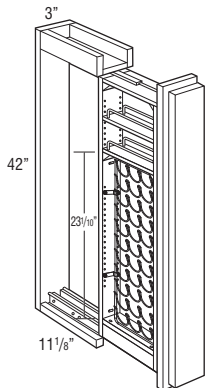

WBCPOKCUP3420L

- Holds 44 K-Cups, compatible with K-Cup pods only.
  - Wire K-Cup rack included for easy field installation on either the left or right side (K-Cups are only accessible from one side). All units include adjustable shelves with chrome rail sides that can be used for future installation if K-Cup insert is no longer desired. Depending on height of pull-out, shelves can be used above or below insert for additional storage:  
30" & 33" high include 4 shelves, not compatible with insert.  
36" & 39" high include 5 shelves, one shelf recommended for use with insert.  
42" high includes 6 shelves, two shelves recommended for use with insert.
  - Overlay application includes profiled full overlay filler.
  - Recommend installation between two cabinets. Can be installed on the end of a run or adjacent to an appliance with a 3/4" thick end panel.
  - All styles feature a natural finish full extension wood pull-out.
  - In order to allow proper clearance for opening and closing, allow an additional 1/8" space between adjacent cabinet face frames. The 3" wide pull-outs require 3 1/8" space. Spacers are included with the pull-outs to allow for proper installation.
  - For full access of upper shelves from both sides of unit, do not install against a wall or next to deeper appliances and cabinets.
  - Finger pull routed on bottom edge of wall unit. Hardware optional.
  - Pull-out does not have Smart Stop feature.
  - Not compatible with face mount moulding.
- \*K-Cup is a registered trademark of Keurig Green Mountain, Inc.

**MODIFICATIONS**

No modifications available for these products.

**Finish Techniques**

Distressing	Heirlooming
•	•

**WALL SPICE PULL-OUT, 30", 33", 36", 39", or 42" HIGH** L O G I X

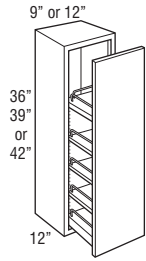
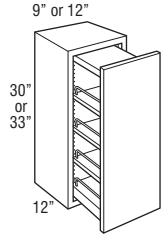

Model	Cubic Feet
WSP930	2.9
WSP1230	3.7
WSP933	3.2
WSP1233	4.1
WSP936	3.5
WSP1236	4.4
WSP939	3.7
WSP1239	4.7
WSP942	4.0
WSP1242	5.1

- 30" and 33" high units include a natural finish, full extension wood pull-out with three adjustable shelves, one fixed shelf, and chrome finish rail sides.
- Wood plugs for top of 30" high pull-out included for field installation.
- 36" to 42" high units include a natural finish, full extension wood pull-out with three adjustable shelves, two fixed shelves, and chrome finish rail sides.
- Wire for top rail on 36" to 42" high pull-out included separately for field installation.
- For full access from both sides of unit, do not install against a wall or next to deeper appliances and cabinets.
- Pull-out does not have Smart Stop feature.

**Custom Modifications**

ADDTK	AUTHL AUTHR	CBO	CCO	CFNTO	CFRMO	CND	EXBKL EXBKR	EXL EXR	FB	FFDL FFDR	FPEB
•	•	•	•		•		•	•	•		•
ID	INVFRM	MIP	P	PFNBMTB	RD	TD	TVRAV TVRFV TVRVV	WLI			
		•		•				•			

**Construction Upgrades**

APC	PE
•	•

**Door Options**

ALF	CG	CG.BTM	CG.TOP	DPSRR	MD	MD.BTM	MD.TOP	MFO
				•				•

**WALL SPICE PULL-DOWN**

L O G I X

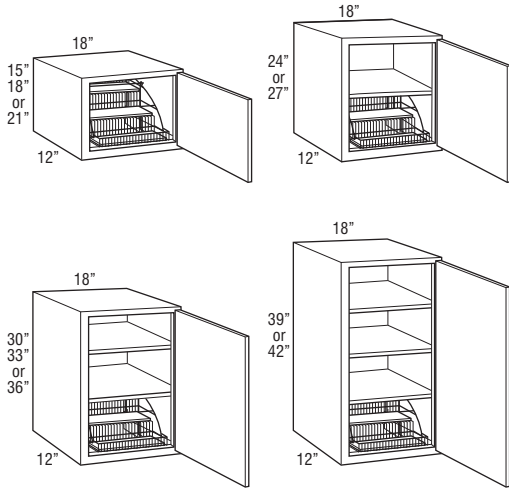

Model	Cubic Feet
W1815SPD L or R	2.8
W1818SPD L or R	3.2
W1821SPD L or R	3.7
W1824SPD L or R	4.2
W1827SPD L or R	4.7
W1830SPD L or R	5.2
W1833SPD L or R	5.7
W1836SPD L or R	6.2
W1839SPD L or R	6.6
W1842SPD L or R	7.1

- Spice Rack Pull-down dimensions: 8 15/16" high x 14 13/16" wide x 10 5/16" deep.
- Interior dimensions of pull-down trays: 11 3/4" wide x 3" deep.
- Maximum Weight Capacity for Spice Rack Pull-down: 15 lbs.
- When Increased Depth (ID) is ordered, insert will not increase in size.

**Custom Modifications**

	AUTHL AUTHR	CBO	CCO	CFNT0	CFRMO	CND	EXBKL EXBKR	EXL EXR	FB	FFDL FFDR	FPFB
	•	•*	•	•	•		•	•	•	•*	•
ID	INVERM	MIP	P	PFINBTMB	RD	TD	TAVRAV TVRFV TVRVV	WLI			
•		•		•				•			

\*Not available on 15", 18", or 21" high \*Not available on 15" high

**Construction Upgrades**

APC	PE
•	•

**Door Options**

ALF	CG	CG.BTM	CG.TOP	DPSRR	MD	MD.BTM	MD.TOP	MFO
	•			•	• <sup>†</sup>			•

<sup>†</sup>Not available on 15", 24", or 27" high

**WALL SHELF PULL-DOWN**

L O G I X

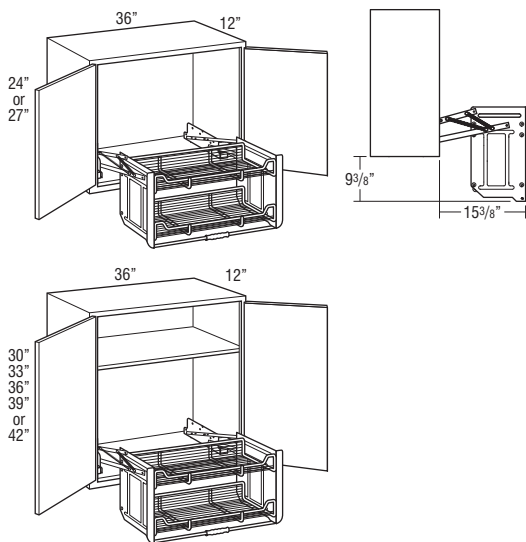

W3624SHLFPD	8.0
W3627SHLFPD	9.3
W3630SHLFPD	10.0
W3633SHLFPD	10.3
W3636SHLFPD	11.8
W3639SHLFPD	11.9
W3642SHLFPD	13.9

- Shelf Pull-down dimensions: 18 11/64" high x 28 1/4" wide x 8 1/2" deep.
- Interior dimensions of pull-down trays: 28 1/4" wide x 8 1/2" deep.
- Clearance dimensions: 19 3/8" high x 15 3/8" wide.
- 30" to 42" high units will have one adjustable shelf above pull-down unit.
- Maximum Weight Capacity for Shelf Pull-down: 26 lbs.

**Custom Modifications**

	AUTHL AUTHR	CBO	CCO	CFNT0	CFRMO	CND	EXBKL EXBKR	EXL EXR	FB	FFDL FFDR	FPFB
	•	•	•	•	•		•	•	•		•
ID	INVERM	MIP	P	PFINBTMB	RD	TD	TAVRAV TVRFV TVRVV	WLI			
		•		•				•			

**Construction Upgrades**

APC	PE
•	•

**Door Options**

ALF	CG	CG.BTM	CG.TOP	DPSRR	MD	MD.BTM	MD.TOP	MFO
	•			•	•			•

**WALL SPICE RACK CABINET, 30", 33", 36", 39", or 42" HIGH** L O G I X

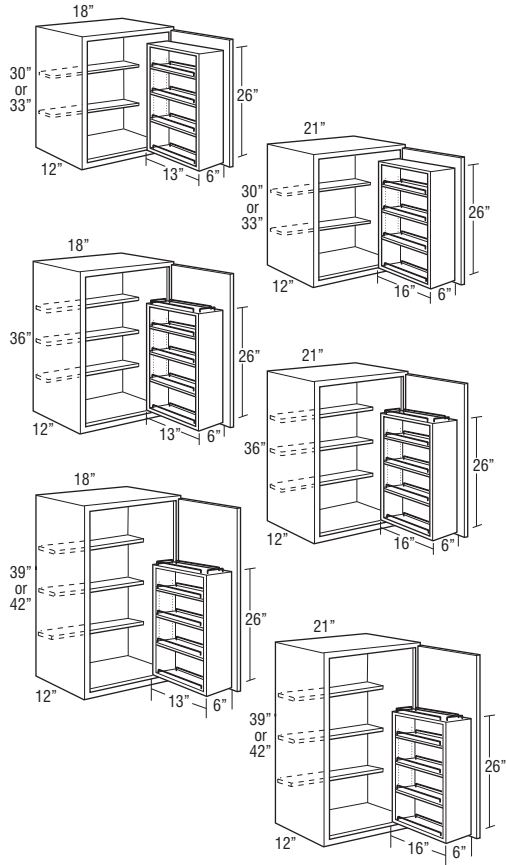

Model	Cubic Feet
WSR1830 L or R	5.3
WSR2130 L or R	6.1
WSR1833 L or R	5.9
WSR2133 L or R	6.7
WSR1836 L or R	6.3
WSR2136 L or R	7.2
WSR1839 L or R	6.8
WSR2139 L or R	7.8
WSR1842 L or R	7.3
WSR2142 L or R	8.3

- Shelves are 4 1/2" deep.
- Field installed swing-out has three adjustable and one fixed bottom shelf with chrome finish wire rail sides.
- Dimensions: WSR18 wood insert is 26" high x 13" wide x 6" deep. WSR21 wood insert is 26" high x 16" wide x 6" deep.
- When Increased Depth (ID) is ordered, wood insert will not increase in size.
- Maximum Weight Capacity for Spice Rack Shelves: 15 lbs.

**Custom Modifications**

	AUTHL AUTHR	CBO	CCO	CFNT0	CFRMO	CND	EXBKL EXBKR	EXL EXR	FB	FFDL FFDR	FPEB
•	•	•	•	•	•		•	•	•		•
ID	INVFRM	MIP	P	PFNBMTB	RD	TD	TVRAV TVRFV TVRVV	WLI			
•		•		•				•			

**Construction Upgrades**

APC	PE
•	•

**Door Options**

ALF	CG	CG.BTM	CG.TOP	DPSRR	MD	MD.BTM	MD.TOP	MFO
	•			•	•			•



**WALL OPEN CABINET with PLAIN BACK, 30", 33", 36", 39", or 42" HIGH**

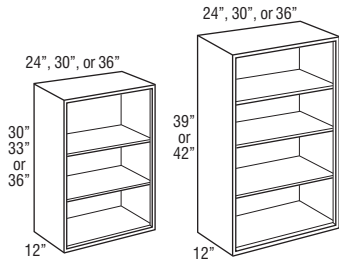

Model	Cubic Feet
WOCP2430	6.7
WOCP3030	8.3
WOCP3630	9.9
WOCP2433	7.4
WOCP3033	9.1
WOCP3633	10.8
WOCP2436	8.0
WOCP3036	9.9
WOCP3636	11.7
WOCP2439	8.6
WOCP3039	10.6
WOCP3639	12.7
WOCP2442	9.3
WOCP3042	11.4
WOCP3642	13.5

- Matching Interior Plywood (MIP) standard.
- Face frame has a profiled inside edge.
- If ordered with Heirlooming Technique, will not feature sand-through characteristics.
- To change the top rail valance, specify one of the following modifications: Arch (TVRAV), Furniture (TVRFV), or Straight Valance (TVRVV).

**Custom Modifications**

ADDTK	AUTHL AUTHR	CBO	CCO	CFNTO	CFRMO	CND	EXBKL EXBKR	EXL EXR	FB	FFDL FFDR	FPEB
•	•	STD			•		•	•			•
ID	INVFRM	MIP	P	PFINBTMB	RD	TD	TVRAV TVRFV TVRVV	WLI			
•		STD	•	•	•		•				

**Construction Upgrades**

APC	PE

**Door Options**

ALF	CG	CG.BTM	CG.TOP	DPSRR	MD	MD.BTM	MD.TOP	MFO

**WALL OPEN CABINET with BEADED BACK, 30", 33", 36", 39", or 42" HIGH**

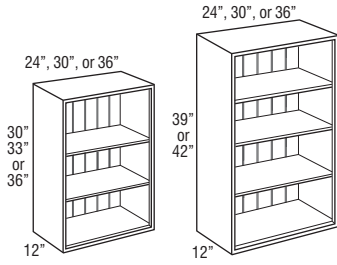

Model	Cubic Feet
WOCB2430	6.9
WOCB3030	8.5
WOCB3630	10.0
WOCB2433	7.4
WOCB3033	9.1
WOCB3633	10.8
WOCB2436	8.0
WOCB3036	9.9
WOCB3636	11.7
WOCB2439	8.6
WOCB3039	10.6
WOCB3639	12.7
WOCB2442	9.3
WOCB3042	11.4
WOCB3642	13.5

- Matching Interior Plywood (MIP) standard.
- Beaded back panel is veneer on furniture board core.
- Face frame has a profiled inside edge.
- If ordered with Heirloom Technique, will not feature sand-through characteristics.
- To change the top rail valance, specify one of the following modifications: Arch (TVRAV), Furniture (TVRFV), or Straight Valance (TVRVV).

**Custom Modifications**

ADDTK	AUTHL AUTHR	CBO	CCO	CFNTO	CFRMO	CND	EXBKL EXBKR	EXL EXR	FB	FFDL FFDR	FPFB
•	•	STD			•		•	•			•
ID	INVFRM	MIP	P	PFINBTMB	RD	TD	TVRAV TVRFV TVRVV	WLI			
•		STD	•	•	•		•				

**Construction Upgrades**

APC	PE

**Door Options**

ALF	CG	CG.BTM	CG.TOP	DPSRR	MD	MD.BTM	MD.TOP	MFO

**WALL CHINA DISPLAY, 15" HIGH**

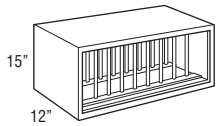

Model	# of Plates
WCD2415	10
WCD3015	13
WCD3615	16

WCD2415	3.0
WCD3015	4.5
WCD3615	6.0

- Matching Interior Plywood (MIP) standard.
- Vertical dowels are 3/8" diameter, 1 1/2" apart.
- Individual dowels are not removable. Complete rack assembly is removable.
- If ordered with Heirloom Technique, will not feature sand-through characteristics.

**Custom Modifications**

ADDTK	AUTHL AUTHR	CBO	CCO	CFNTO	CFRMO	CND	EXBKL EXBKR	EXL EXR	FB	FFDL FFDR	FPFB
•		STD			•		•	•			•
ID	INVFRM	MIP	P	PFINBTMB	RD	TD	TVRAV TVRFV TVRVV	WLI			
		STD		•							

**Construction Upgrades**

APC	PE

**Door Options**

ALF	CG	CG.BTM	CG.TOP	DPSRR	MD	MD.BTM	MD.TOP	MFO

**WALL CHINA DISPLAY with DOORS,  
30", 33", 36", 39", or 42" HIGH**

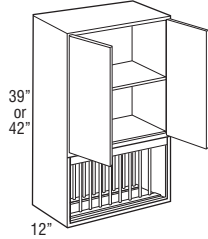
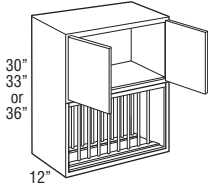

Model	# of Plates
WCD2430	10
WCD3030	13
WCD3630	16
WCD2433	10
WCD3033	13
WCD3633	16
WCD2436	10
WCD3036	13
WCD3636	16
WCD2439AH	10
WCD3039AH	13
WCD3639AH	16
WCD2442AH	10
WCD3042AH	13
WCD3642AH	16

Model	Cubic Feet
WCD2430	6.9
WCD3030	8.5
WCD3630	10.0
WCD2433	7.6
WCD3033	9.4
WCD3633	11.2
WCD2436	8.2
WCD3036	10.0
WCD3636	11.9
WCD2439AH	8.8
WCD3039AH	10.8
WCD3639AH	12.5
WCD2442AH	9.4
WCD3042AH	11.6
WCD3642AH	13.8

- Matching Interior Plywood (MIP) standard.
- Vertical dowels are 3/8" diameter, 1 1/2" apart.
- Individual dowels are not removable. Complete rack assembly is removable.
- China display section has 12" frame opening height.

**Custom Modifications**

ADDTK	AUTHL AUTHR	CBO	CCO	CFNTO	CFRMO	CND	EXBKL EXBKR	EXL EXR	FB	FFDL FFDR	FPEB
•	•	•	•*	•	•		•	•			•
ID	INVFRM	MIP	P	PFINBTMB	RD	TD	TAVR TVRFV TVRVV	WLI			
		STD		•							

\*Available only on 39" and 42" high

**Construction Upgrades**

APC	PE

**Door Options**

ALF	CG	CG.BTM	CG.TOP	DPSRR	MD	MD.BTM	MD.TOP	MFO
	•			•				•

**WALL WINE RACK, 15", 18", or 30" HIGH**

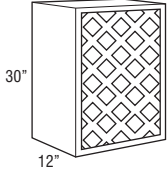
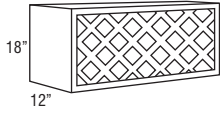

Model	# of Bottles
WNR3015	11
WNR3315	13
WNR3615	13
WNR3018	11
WNR3318	13
WNR3618	13
WNR1530	11
WNR1830	11
WNR2130	11

Model	Cubic Feet
WNR3015	4.5
WNR3315	4.9
WNR3615	5.4
WNR3018	5.3
WNR3318	5.8
WNR3618	6.3
WNR1530	4.5
WNR1830	5.3
WNR2130	6.1

- Matching Interior Plywood (MIP) standard.
- Cabinet interior finished to match cabinet face frame.
- Solid-wood lattice work.
- Wine bottle opening 4" x 4".
- If ordered with Heirloom Technique, will not feature sand-through characteristics.

**Custom Modifications**

ADDTK	AUTHL AUTHR	CBO	CCO	CFNTO	CFRMO	CND	EXBKL EXBKR	EXL EXR	FB	FFDL FFDR	FPEB
•		STD			•		•	•			•
ID	INVERM	MIP	P	PFNBMB	RD	TD	TAVR TVRFV TVRVV	WLI			
		STD		•							

**Construction Upgrades**

APC	PE

**Door Options**

ALF	CG	CG.BTM	CG.TOP	DPSRR	MD	MD.BTM	MD.TOP	MFO

**WINE STORAGE CABINET, 12", 15", 18", 21", or 24" HIGH**

L O G I X

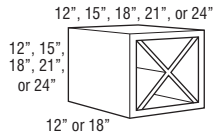

Model	# of Bottles
WSC121212	4
WSC151512	10
WSC181812	18
WSC181818	18
WSC212112	24
WSC242412	32

WSC121212	1.6
WSC151512	2.3
WSC181812	3.2
WSC181818	4.3
WSC212112	4.3
WSC242412	5.5

- Matching Interior Plywood (MIP) standard.
- Must be installed between two cabinets, between a cabinet and a wall, or mounted to a horizontal surface.
- "X" shelf configuration cannot be removed.
- If ordered with Heirloom Technique, will not feature sand-through characteristics.
- Reduced depth not recommended for safe wine bottle storage.

**Custom Modifications**

ADDTK	AUTHL AUTHR	CBO	CCO	CFNTO	CFRMO	CND	EXBKL EXBKR	EXL EXR	FB	FFDL FFDR	FPEB
							•				•
ID	INVERM	MIP	P	PFNBMB	RD	TD	TAVR TVRFV TVRVV	WLI			
•*		STD		•	•						

\*ID on 12" deep models available up to 18" deep

**Construction Upgrades**

APC	PE

**Door Options**

ALF	CG	CG.BTM	CG.TOP	DPSRR	MD	MD.BTM	MD.TOP	MFO

**WALL WINE CUBBY, 24", 30", 36", or 42" WIDE, 6" HIGH**

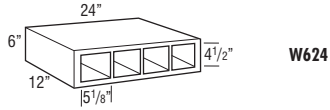

**W624**

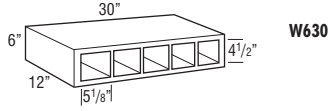

**W630**

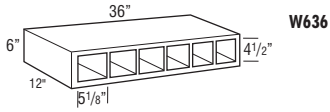

**W636**

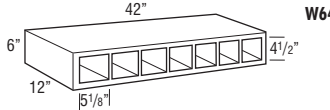

**W642**

Model	Cubic Feet
<b>W624</b> (4 openings)	1.8
<b>W630</b> (5 openings)	2.2
<b>W636</b> (6 openings)	2.7
<b>W642</b> (7 openings)	3.0

- Veneer on 3/4" furniture board core.
- Matching interior.
- Frameless construction.
- If ordered with Heirlooming Technique, will not feature sand-through characteristics.
- Increased Depth only available in 3" increments.

**Custom Modifications**

ADDTK	AUTHL AUTHR	CBO	CCO	CFNTO	CFRMO	CND	EXBKL EXBKR	EXL EXR	FB	FFDL FFDR	FPEB
									STD		
ID	INVFRM	MIP	P	PFINBTMB	RD	TD	TVRAV TVRFV TVRVV	WLI			
•											

**Construction Upgrades**

APC	PE

**Door Options**

ALF	CG	CG.BTM	CG.TOP	DPSRR	MD	MD.BTM	MD.TOP	MFO

**WALL ORGANIZER, 24", 30", or 36" WIDE, 6" HIGH**

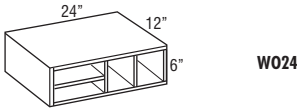

**W024**

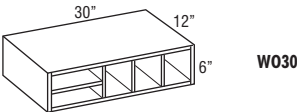

**W030**

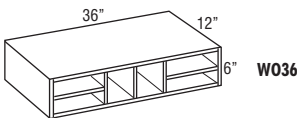

**W036**

<b>W024</b>	1.8
<b>W030</b>	2.2
<b>W036</b>	2.7

- Veneer on a 3/4" furniture board core.
- Frameless construction.
- Matching interior.
- If ordered with Heirlooming Technique, will not feature sand-through characteristics.
- Increased Depth only available in 3" increments.

**Custom Modifications**

ADDTK	AUTHL AUTHR	CBO	CCO	CFNTO	CFRMO	CND	EXBKL EXBKR	EXL EXR	FB	FFDL FFDR	FPEB
									STD		
ID	INVFRM	MIP	P	PFINBTMB	RD	TD	TVRAV TVRFV TVRVV	WLI			
•											

**Construction Upgrades**

APC	PE

**Door Options**

ALF	CG	CG.BTM	CG.TOP	DPSRR	MD	MD.BTM	MD.TOP	MFO

**WALL SPICE DRAWER, 24", 30", 36", or 42" WIDE, 6" HIGH**

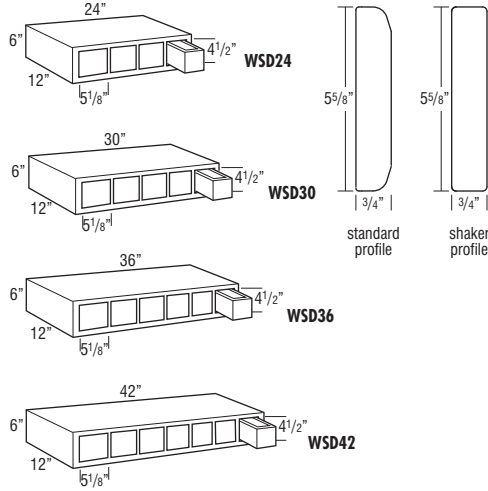

Model	Cubic Feet
<b>WSD24</b> (4 drawers)	1.8
<b>WSD30</b> (5 drawers)	2.2
<b>WSD36</b> (6 drawers)	2.7
<b>WSD42</b> (7 drawers)	3.0

- Drawer front is unique to item and will not match profile chosen.
- All styles use standard drawer front profile except Anden, Breman, Caldera, Davis, LaGrange, Leeton, Liberty, Montgomery, Sumner, Trystan, and Wells, which use the shaker profile.
- Graniti, Tranter, and Wixom, Worthen drawer fronts will match doors and drawer fronts.
- Veneer on 3/4" furniture board core.
- 1/2" hardwood drawer with rabbet joint.
- Horizontal application only.
- Matching interior.
- Frameless construction.
- Increased Depth only available in 3" increments.

**Custom Modifications**

ADDTK	AUTHL AUTHR	CBO	CCO	CFNT0	CFRMO	CND	EXBKL EXBKR	EXL EXR	FB	FFDL FFDR	FPEB
									STD		
ID	INVERM	MIP	P	PFNBTAB	RD	TD	TVRAV TVRFV TVRVV	WLI			
•											

**Construction Upgrades**

APC	PE

**Door Options**

ALF	CG	CG.BTM	CG.TOP	DPSRR	MD	MD.BTM	MD.TOP	MFO

**FLOATING SHELVES**

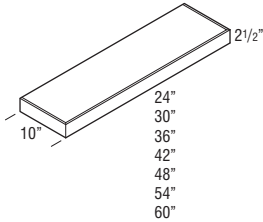

<b>FS24</b>	0.7
<b>FS30</b>	0.9
<b>FS36</b>	1.0
<b>FS42</b>	1.2
<b>FS48</b>	1.3
<b>FS54</b>	1.5
<b>FS60</b>	1.6

- Not available in Hickory.
- FS48, FS54, FS60 sizes are available in Maple and Cherry only.
- When ordered in Rustic Alder door styles, will not feature rustic characteristics.
- Maximum Weight Capacity per shelf:
  - 24" = 30 lbs.
  - 30" = 37.5 lbs.
  - 36" = 45 lbs.
  - 42" = 52.2 lbs.
  - 48" = 60 lbs.
  - 54" = 67.5 lbs.
  - 60" = 75 lbs.
- 3/4" thick solid-wood front, back, and ends. 3/8" thick veneered plywood top and bottom. Front and ends are mitered together.

**MODIFICATIONS**

No modifications available for these products.

**TRAY SHELVES**

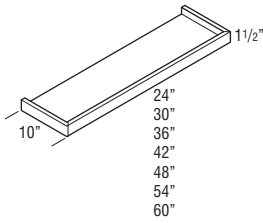

Model	Cubic Feet
<b>TRAYSHELF2410</b>	0.8
<b>TRAYSHELF3010</b>	0.9
<b>TRAYSHELF3610</b>	1.1
<b>TRAYSHELF4210</b>	1.3
<b>TRAYSHELF4810</b>	1.4
<b>TRAYSHELF5410</b>	1.6
<b>TRAYSHELF6010</b>	1.8

- When ordered in Rustic Alder door styles, will not feature rustic characteristics.
- Must be securely attached to wall with corbels or other shelf supports. A center support is also recommended on 42"-60" wide applications.
- 1/2" thick veneered plywood panel.

**Custom Modifications**

ADDTK	AUTHL AUTHR	CBO	CCO	CFNTO	CFRMO	CND	EXBKL EXBKR	EXL EXR	FB	FFDL FFDR	FPFB
ID	INVERM	MIP	P	PFINBTMB	RD	TD	TVRAV TVRFV TVRVV	WLI			
•					•						

**Construction Upgrades**

APC	PE

**Door Options**

ALF	CG	CG.BTM	CG.TOP	DPSRR	MD	MD.BTM	MD.TOP	MFO

**WALL CORNER DECORATIVE SHELF**

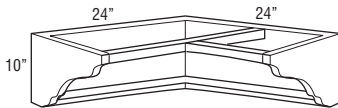

<b>WCS2424</b>	4.7
----------------	-----

- Bottom shelf depth is 3".
- Requires 24" x 24" corner wall space.
- Top is open; designed to mount under Easy Reach or Corner Cabinet.
- 3/4" hardwood end panel and shelf with 3/8" plywood back panel.
- Matching interior.

**MODIFICATIONS**

No modifications available for these products.

**Finish Techniques**

Distressing	Heirlooming
•	

**WALL DECORATIVE SHELF, 10" HIGH**

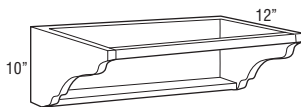

<b>WS12</b>	1.4
<b>WS15</b>	1.7
<b>WS18</b>	2.0
<b>WS21</b>	2.3
<b>WS24</b>	2.6
<b>WS30</b>	3.2
<b>WS36</b>	3.8

- Bottom shelf depth is 3".
- Top is open; designed to mount under wall cabinet.
- 3/4" hardwood end panel and shelf with 3/8" plywood back panel.
- Matching interior.

**MODIFICATIONS**

No modifications available for these products.

**WALL MESSAGE CENTER, 30", 33", 36", 39", or 42" HIGH, 3" DEEP**

L O G I X

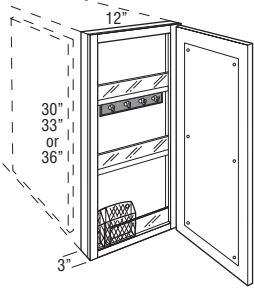

WMC1230 L or R  
WMC1233 L or R  
WMC1236 L or R

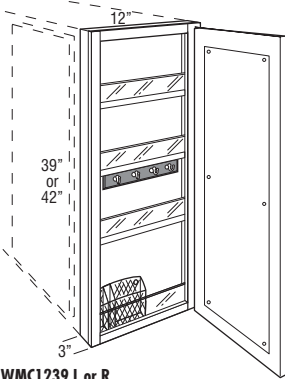

WMC1239 L or R  
WMC1242 L or R

Model	Cubic Feet
WMC1230 L or R	1.8
WMC1233 L or R	1.9
WMC1236 L or R	2.2
WMC1239 L or R	2.5
WMC1242 L or R	2.9

- Includes magnetic whiteboard on back of door, key hooks, pencil holder, and fixed plexi-glass fronted shelves.
- WMC1230, WMC1233 L or R, and WMC1236 have 2 fixed shelves. WMC1239 and WMC1242 have 3 fixed shelves.
- Not recommended for use next to a Peninsula cabinet due to the additional 1/4" cabinet depth.
- Door will open 90° without decorative hardware.
- Cabinet should be hinged on wall side.
- For proper installation, adjacent cabinet must have FPEB or 1/4" skin applied.
- Embellishments or overlay fillers can be used on side of cabinet to add a decorative touch.

**Custom Modifications**

	ADDTK	AUTHL AUTHR	CBO	CCO	CFNTO	CFRMO	CND	EXBKL EXBKR	EXL EXR	FB	FFDL FFDR	FPEB STD
			•	•								
ID		INVFRM	MIP	P	PFNBTAB	RD	TD	TVRAV TVRFV TVRVV	WLI			
			•						•			

**Construction Upgrades**

APC	PE
•	

**Door Options**

ALF	CG	CG.BTM	CG.TOP	DPSRR	MD	MD.BTM	MD.TOP	MFO
				•				•

**WOOD HOOD ARCH, 36", 42", or 48" WIDE, 24 7/8" HIGH**

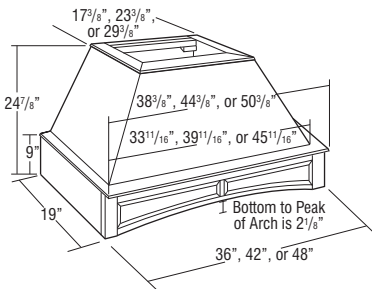

WHA36	14.0
WHA42	16.0
WHA48	18.0

- Freestanding unit (must be properly secured to wall and cannot be attached to adjacent cabinets).
- Exhaust system not included. Compatible with all Diamond blowers.
- Chimney available (WHC...). See page 159.
- Check your local building code for installation heights above the range.
- Silver metallic liner included. Assembly required.
- Arched raised panel valance front.
- Installation instructions and hardware included.
- Liner opening size: 10 1/4" deep by 19 1/2" wide.
- Wood hoods ordered in Rustic Alder will not feature Rustic characteristics.

**MODIFICATIONS**

No modifications available for these products.

**Finish Techniques**

Distressing	Heirlooming
•	•



**WOOD HOOD SQUARE, 36", 42", or 48" WIDE, 22 7/8" HIGH**

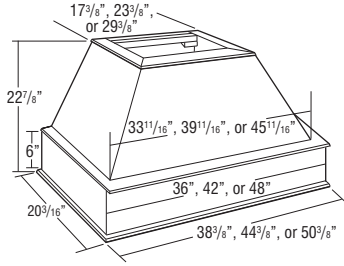

Model	Cubic Feet
WHS36	13.0
WHS42	14.0
WHS48	16.0

- Wood hoods are designed for use with decorative overlays.
- Freestanding unit (must be properly secured to wall and cannot be attached to adjacent cabinets).
- Exhaust system not included. Compatible with all Diamond blowers.
- Chimney available (WHC.). See page 159.
- Check your local building code for installation heights above the range.
- Silver metallic liner included. Assembly required.
- Installation instructions and hardware included.
- Liner opening size: 10 1/4" deep by 19 1/2" wide.
- Wood hoods ordered in Rustic Alder will not feature Rustic characteristics.

MODIFICATIONS
No modifications available for these products.

**Finish Techniques**

Distressing	Heirlooming
•	•

**WOOD HOOD CHIMNEY, 23 1/2" HIGH**

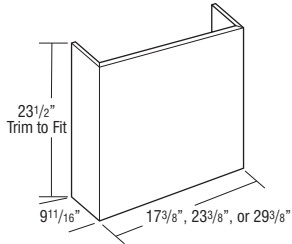

WHC36	3.0
WHC42	4.0
WHC48	5.0

- 3/4" thick plywood.
- Trimmable.
- If trimmed, moulding is recommended to conceal any cut marks.
- Optional accessory for Wood Hood Square (WHS) and Wood Hood Arch (WHA).
- Wood hoods ordered in Rustic Alder will not feature Rustic characteristics.

MODIFICATIONS
No modifications available for these products.

**Finish Techniques**

Distressing	Heirlooming
•	•

**WOOD HOOD CONTEMPORARY STRAIGHT, 30", 36", or 42" WIDE**

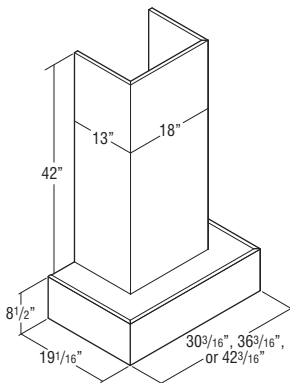

JWHCONSTR30	18.1
JWHCONSTR36	18.1
JWHCONSTR42	18.1

- Freestanding unit (must be properly secured to wall and cannot be attached to adjacent cabinets).
- Exhaust system not included. Compatible with all Diamond blowers.
- Chimney included and can be trimmed. If trimmed, moulding is recommended to cover any cut marks.
- Check your local building code for installation heights above the range.
- Silver metallic liner included. Assembly required.
- Installation instructions and hardware included.
- Liner opening size: 10 1/4" deep by 19 1/2" wide.
- Wood hoods ordered in Rustic Alder will not feature Rustic characteristics.
- Available in glaze finishes, but wood hood design does not provide detail for glaze hang-up.
- No changes or cancellations will be accepted after 24 hours from acknowledgment of order.

MODIFICATIONS
No modifications available for these products.

**Finish Techniques**

Distressing	Heirlooming
•	•

**WOOD HOOD LINEAR, TAPERED,  
30", 36", or 42" WIDE**

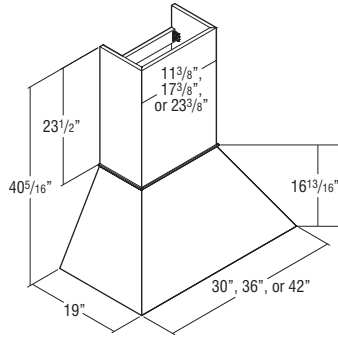

Model	Cubic Feet
JWHL30	14.0
JWHL36	16.0
JWHL42	18.0

- Freestanding unit (must be properly secured to wall and cannot be attached to adjacent cabinets).
- Exhaust system not included. Compatible with all Diamond blowers.
- Chimney included and can be trimmed.
- Check your local building code for installation heights above the range.
- Silver metallic liner included. Assembly required.
- Installation instructions and hardware included.
- Liner opening size: 10 1/4" deep by 19 1/2" wide.
- Wood hoods ordered in Rustic Alder will not feature Rustic characteristics.
- Available in glaze finishes, but wood hood design does not provide detail for glaze hang-up.
- No changes or cancellations will be accepted after 24 hours from acknowledgment of order.

MODIFICATIONS
No modifications available for these products.

**WOOD HOOD SHIPLAP, STRAIGHT,  
36", 42", or 48" WIDE**

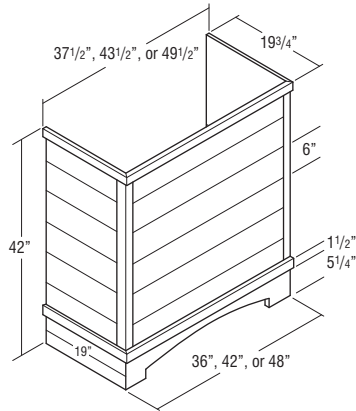

JWHSHPSTR36	22.0
JWHSHPSTR42	25.2
JWHSHPSTR48	28.4

- Freestanding unit (must be properly secured to wall and cannot be attached to adjacent cabinets).
- Constructed of 3/4" thick grooved plywood creating a shiplap appearance.
- Trimable. If trimmed, moulding is recommended to conceal any cut marks.
- Exhaust system not included. Compatible with all Diamond blowers.
- Check local building code and appliance installation specifications for clearance requirements and installation heights above the range.
- Silver metallic liner included. Assembly required.
- Installation instructions and hardware included.
- Liner opening size: 10 1/4" deep by 19 1/2" wide.
- Wood hoods ordered in Rustic Alder will not feature Rustic characteristics.
- Not available in Hickory.
- No changes or cancellations will be accepted after 24 hours from acknowledgment of order.

MODIFICATIONS
No modifications available for these products.

**Finish Techniques**

Distressing	Heirlooming
•	•

**WOOD HOOD SHIPLAP, STRAIGHT  
with CORBELS, 36", 42", or 48" WIDE**

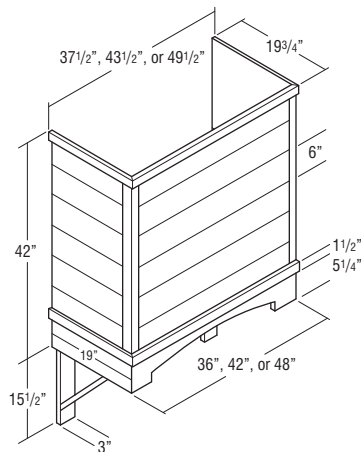

JWHSHPSTRCB36	22.0
JWHSHPSTRCB42	25.2
JWHSHPSTRCB48	28.4

- Includes a pair of decorative corbels.
- Freestanding unit (must be properly secured to wall and cannot be attached to adjacent cabinets).
- Constructed of 3/4" thick grooved plywood creating a shiplap appearance.
- Trimable. If trimmed, moulding is recommended to conceal any cut marks.
- Exhaust system not included. Compatible with all Diamond blowers.
- Check local building code and appliance installation specifications for clearance requirements (including corbels) and installation heights above the range.
- Silver metallic liner included. Assembly required.
- Installation instructions and hardware included.
- Liner opening size: 10 1/4" deep by 19 1/2" wide.
- Wood hoods ordered in Rustic Alder will not feature Rustic characteristics.
- Not available in Hickory.
- No changes or cancellations will be accepted after 24 hours from acknowledgment of order.

MODIFICATIONS
No modifications available for these products.

**Finish Techniques**

Distressing	Heirlooming
•	•

**WOOD HOOD SHIPLAP, TAPERED,  
30", 36", 42", or 48" WIDE**

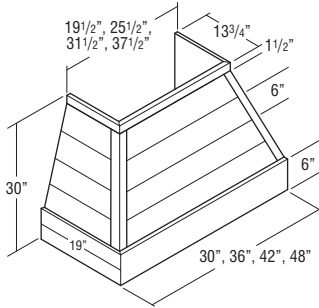

Model	Cubic Feet
JWHSIPT30	22.0
JWHSIPT36	22.0
JWHSIPT42	25.2
JWHSIPT48	28.4

- Freestanding unit (must be properly secured to wall and cannot be attached to adjacent cabinets).
- Constructed of 3/4" thick grooved plywood creating a shiplap appearance.
- Exhaust system not included. Compatible with all Diamond blowers.
- Compatible with Shiplap Chimney (JWHSIPCH\_ ), which can be trimmed. See below.
- Check local building code and appliance installation specifications for clearance requirements and installation heights above the range.
- Silver metallic liner included. Assembly required.
- Installation instructions and hardware included.
- Liner opening size: 10 1/4" deep by 19 1/2" wide.
- Wood hoods ordered in Rustic Alder will not feature Rustic characteristics.
- Not available in Hickory.
- No changes or cancellations will be accepted after 24 hours from acknowledgment of order.

MODIFICATIONS
No modifications available for these products.

**Finish Techniques**

Distressing	Heirlooming
•	•

**WOOD HOOD SHIPLAP, TAPERED with  
CORBELS, 36", 42", or 48" WIDE**

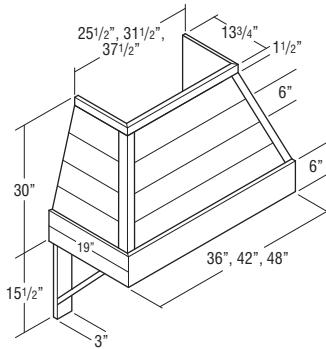

JWHSIPTCB36	22.0
JWHSIPTCB42	25.2
JWHSIPTCB48	28.4

- Includes a pair of decorative corbels.
- Freestanding unit (must be properly secured to wall and cannot be attached to adjacent cabinets).
- Constructed of 3/4" thick grooved plywood creating a shiplap appearance.
- Exhaust system not included. Compatible with all Diamond blowers.
- Compatible with Shiplap Chimney (JWHSIPCH\_ ), which can be trimmed. See below.
- Check local building code and appliance installation specifications for clearance requirements (including corbels) and installation heights above the range.
- Silver metallic liner included. Assembly required.
- Installation instructions and hardware included.
- Liner opening size: 10 1/4" deep by 19 1/2" wide.
- Wood hoods ordered in Rustic Alder will not feature Rustic characteristics.
- Not available in Hickory.
- No changes or cancellations will be accepted after 24 hours from acknowledgment of order.

MODIFICATIONS
No modifications available for these products.

**Finish Techniques**

Distressing	Heirlooming
•	•

**WOOD HOOD SHIPLAP CHIMNEY,  
30", 36", 42", or 48" WIDE**

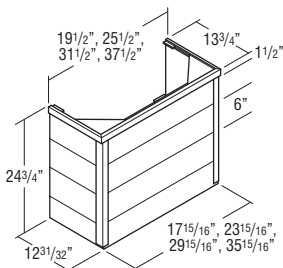

JWHSIPCH30	2.8
JWHSIPCH36	2.8
JWHSIPCH42	3.8
JWHSIPCH48	4.7

- Constructed of 3/4" thick grooved plywood creating a shiplap appearance.
- Trimtable. If trimmed, moulding is recommended to conceal any cut marks.
- Optional accessory for Wood Hood Shiplap Tapered (JWHSIPT\_ \_ and JWHSIPTCB\_ \_ ) for an installed height of 54".
- Wood hoods ordered in Rustic Alder will not feature Rustic characteristics.
- Not available in Hickory.
- No changes or cancellations will be accepted after 24 hours from acknowledgment of order.

MODIFICATIONS
No modifications available for these products.

**Finish Techniques**

Distressing	Heirlooming
•	•

**WOOD HOOD CANOPY ARCHED,  
30" or 36" WIDE, 24" HIGH**

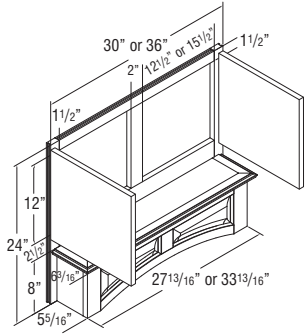

Model	Cubic Feet
WHCA30	4.7
WHCA36	5.6

- Install Wood Hoods between adjacent cabinets.
- Doors matching the style ordered will be installed on hood.
- Exhaust system not included. Compatible with all Diamond blowers.
- Check your local building code for installation heights above the range.
- Silver metallic liner included. Assembly required. Interior bottom section is finished below liner. Liner is not arched.
- Installation instructions and hardware included.
- Liner opening size: 10 1/4" deep by 19 1/2" wide.
- When ordered in Rustic Alder, only the doors will have Rustic characteristics.
- Arched raised panel valance front.

**MODIFICATIONS**  
No modifications available for these products.

**Door Options**

ALF	CG	CG.BTM	CG.TOP	DPSRR	MD	MD.BTM	MD.TOP	MFO
								•

**Finish Techniques**

Distressing	Heirlooming
•	•

**WOOD HOOD CANOPY ARCHED,  
30" or 36" WIDE, 30" HIGH**

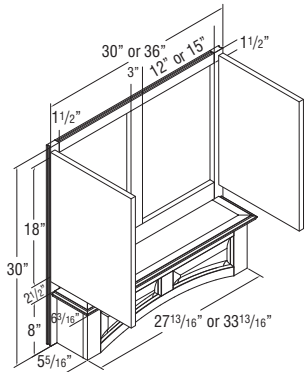

JWHCA3030	8.9
JWHCA3630	10.6

- Install Wood Hoods between adjacent cabinets.
- Doors matching the style ordered will be installed on hood.
- Exhaust system not included. Compatible with all Diamond blowers.
- Check your local building code for installation heights above the range.
- Silver metallic liner included. Assembly required. Interior bottom section is finished below liner. Liner is not arched.
- Installation instructions and hardware included.
- Liner opening size: 10 1/4" deep by 19 1/2" wide.
- When ordered in Rustic Alder, only the doors will have Rustic characteristics.
- Filter is not required unless using a ductless conversion kit. If ductless conversion kit required, see CONVERSION on page 165.
- Designed for use with FILTER250/390, see page 165.
- Arched raised panel valance front.
- No changes or cancellations will be accepted after 24 hours from acknowledgment of order.

**MODIFICATIONS**  
No modifications available for these products.

**Door Options**

ALF	CG	CG.BTM	CG.TOP	DPSRR	MD	MD.BTM	MD.TOP	MFO
								•

**Finish Techniques**

Distressing	Heirlooming
•	•

**WOOD HOOD CANOPY SQUARE,  
30" or 36" WIDE, 24" HIGH**

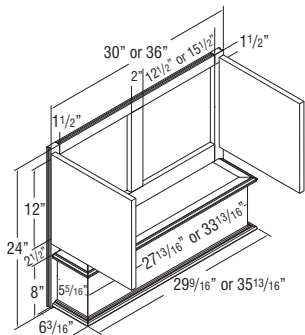

WHCS30	4.7
WHCS36	5.6

- Install Wood Hoods between adjacent cabinets.
- Doors matching the style ordered will be installed on hood.
- Exhaust system not included. Compatible with all Diamond blowers.
- Check your local building code for installation heights above the range.
- Silver metallic liner included. Assembly required. Interior bottom section is finished below liner.
- Installation instructions and hardware included.
- Liner opening size: 10 1/4" deep by 19 1/2" wide.
- When ordered in Rustic Alder, only the doors will have Rustic characteristics.

**MODIFICATIONS**  
No modifications available for these products.

**Door Options**

ALF	CG	CG.BTM	CG.TOP	DPSRR	MD	MD.BTM	MD.TOP	MFO
								•

**Finish Techniques**

Distressing	Heirlooming
•	•

**WOOD HOOD CANOPY SQUARE,  
30" or 36" WIDE, 30" HIGH**

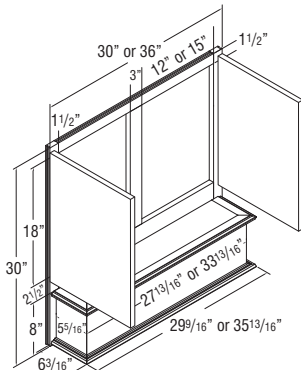

Model	Cubic Feet
JWHCS3030	8.9
JWHCS3630	10.6

- Install Wood Hoods between adjacent cabinets.
- Doors matching the style ordered will be installed on hood.
- Exhaust system not included. Compatible with all Diamond blowers.
- Check your local building code for installation heights above the range.
- Silver metallic liner included. Assembly required. Interior bottom section is finished below liner.
- Installation instructions and hardware included.
- Liner opening size: 10 1/4" deep by 19 1/2" wide.
- When ordered in Rustic Alder, only the doors will have Rustic characteristics.
- Filter is not required unless using a ductless conversion kit. If ductless conversion kit required, see CONVERSION on page 165.
- Designed for use with FILTER250/390, see page 165.
- No changes or cancellations will be accepted after 24 hours from acknowledgment of order.

MODIFICATIONS
No modifications available for these products.

Door Options								
ALF	CG	CG.BTM	CG.TOP	DPSRR	MD	MD.BTM	MD.TOP	MFO
								•

Finish Techniques	
Distressing	Heirlooming
•	•

**WOOD HOOD ISLAND ARCH,  
36", 42", or 48" WIDE**

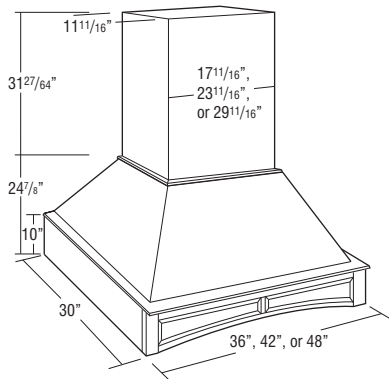

JWHIA36	19.0
JWHIA42	22.0
JWHIA48	25.0

- Check your local building codes for installation heights above the range.
- Exhaust system not included. Compatible with all Diamond blowers.
- Liner opening size: 10 1/4" D x 19 1/2" W.
- Wood hoods ordered in Rustic Alder will not feature rustic characteristics.
- Silver metallic liner included, assembly required.
- Installation kit, instructions and hardware included. Kit includes: ceiling mounting board assembly, spacers, outside corner mouldings, top trim mouldings, front, back, and end panels.
- No changes or cancellations will be accepted after 24 hours from acknowledgment of order.

MODIFICATIONS
No modifications available for these products.

Finish Techniques	
Distressing	Heirlooming
•	•

**WOOD HOOD ISLAND SQUARE,  
36", 42", or 48" WIDE**

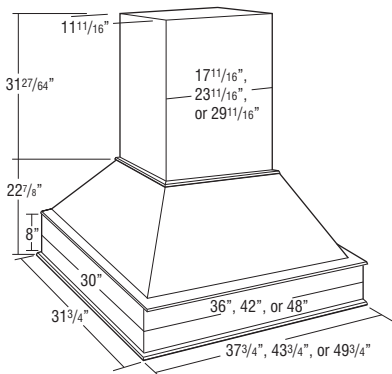

JWHIS36	19.0
JWHIS42	22.0
JWHIS48	25.0

- Check your local building codes for installation heights above the range.
- Exhaust system not included. Compatible with all Diamond blowers.
- Liner opening size: 10 1/4" D x 19 1/2" W.
- Wood hoods ordered in Rustic Alder will not feature rustic characteristics.
- Silver metallic liner included, assembly required.
- Installation kit, instructions and hardware included. Kit includes: ceiling mounting board assembly, spacers, outside corner mouldings, top trim mouldings, front, back, and end panels.
- No changes or cancellations will be accepted after 24 hours from acknowledgment of order.

MODIFICATIONS
No modifications available for these products.

Finish Techniques	
Distressing	Heirlooming
•	•

**TAPERED WOOD HOOD,  
30" or 36" WIDE, 24" HIGH**

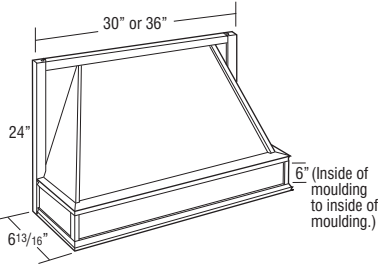

Model	Cubic Feet
TWH30	6.9
TWH36FW	8.6

- Wood hoods are designed for use with decorative overlays.
- Install Wood Hood between adjacent cabinets.
- Exhaust system not included. Compatible with all Diamond blowers.
- Check your local building code for installation heights above the range.
- Tapered design.
- Liner opening size: 10 1/4" deep x 19 1/2" wide.
- Silver metallic liner included, not available for order separately.
- Wood hoods ordered in Rustic Alder will not feature Rustic characteristics.

MODIFICATIONS
No modifications available for these products.

**Finish Techniques**

Distressing	Heirlooming
•	

**WOOD HOOD BLOWER, 1100 CFM**



BLOWER 1100	10.7
-------------	------

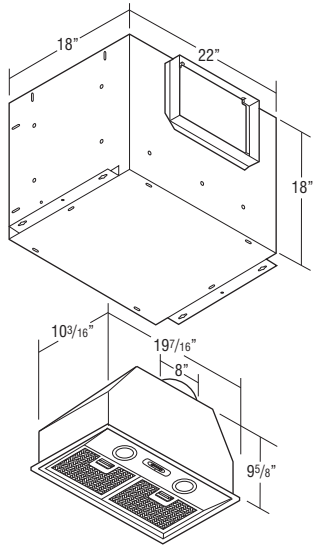

- 1100 CFM.
- One year warranty.
- Ventilator housing unit features stainless steel finish.
- Two 50 watt (120 volt) halogen lamps included.
- Satellite blower installs remotely in the interior of the home (i.e., unfinished attic area.)
- Designed to work independently from internal blowers.
- Installation instructions, warranty, and repair information included.
- External ventilation required.
- Professional installation required.
- Compatible with all Wood Hoods and Hearths.
- Includes two in-line transitions (8" x 12" to 10" round).
- Includes two removable dishwasher safe grease filters.
- Designed for use in applications up to 110,000 BTUs.

MODIFICATIONS
No modifications available for these products.

**WOOD HOOD BLOWER, 500 CFM**



BLOWER 500	4.0
------------	-----

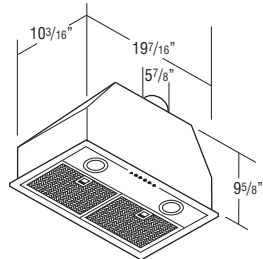

- 500 CFM.
- One year warranty.
- Sound rating is 8.2 sones.
- Two 20 watt (12 volt, G4 base) halogen lamps included.
- Installation instructions, warranty, and repair information included.
- Silver metallic finish.
- Three speed push button control.
- Includes two removable dishwasher safe grease filters.
- Compatible with all Wood Hoods and Hearths.
- Designed for use in applications up to 60,000 BTUs.

MODIFICATIONS
No modifications available for these products.

**TAPERED WOOD HOOD BLOWER**

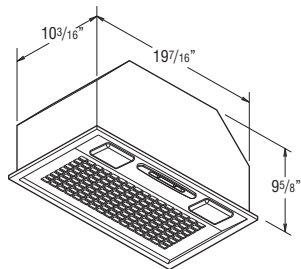

**TWHBLOWER390**

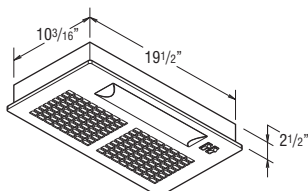

**TWHBLOWER250**

Model	Cubic Feet
<b>TWHBLOWER390</b>	2.1
<b>TWHBLOWER250</b>	2.1



- Range Hood Component Package has 3-speed centrifugal fan and lighted filter control.
- 6" diameter vent.
- 1 year warranty.
- Sound rating is 6 sones.
- Uses 3.2 amps.
- Two 40 watt candelabra lights required, but not included.
- Compatible with all Wood Hoods and Hearths.
- Silver metallic exterior finish.
- Includes removable dishwasher safe grease filter.

- Range Hood Component Package has 2-speed single axial fan with lighted filter control.
- 7" diameter vent.
- 1 year warranty.
- Sound rating is 8 sones.
- Uses 2.1 amps.
- Two 40 watt candelabra lights required, but not included.
- Compatible with all Wood Hoods and Hearths.
- Silver metallic exterior finish.
- Includes removable dishwasher safe grease filter.

MODIFICATIONS
No modifications available for these products.

**WOOD HOOD DUCTLESS CONVERSION KIT AND FILTER KITS**

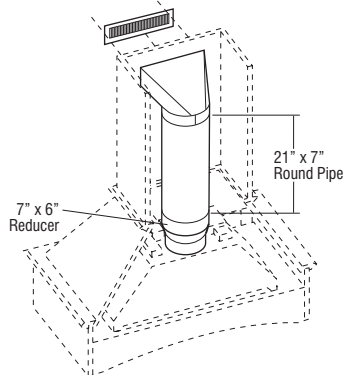

**CONVERSION**



<b>CONVERSION</b>	2.0
<b>FILTER250/390</b>	0.5
<b>FILTER500</b>	0.5

- Must order charcoal filter with CONVERSION kit for proper filtration to replace metal mesh filters included with blower unit.
- FILTER250/390 required when CONVERSION is used with TWHBLOWER250/TWHBLOWER390.
- FILTER500 required when CONVERSION is used with BLOWER500.
- CONVERSION includes: (1) 21" x 7" round pipe, (1) adjustable collar, (1) white metal soffit grille (11 3/8" x 3 5/8"), (1) adjustable boot, (1) 7" x 6" reducer, and installation instructions.

MODIFICATIONS
No modifications available for these products.

**HEARTH, 48" HIGH, 21" DEEP**

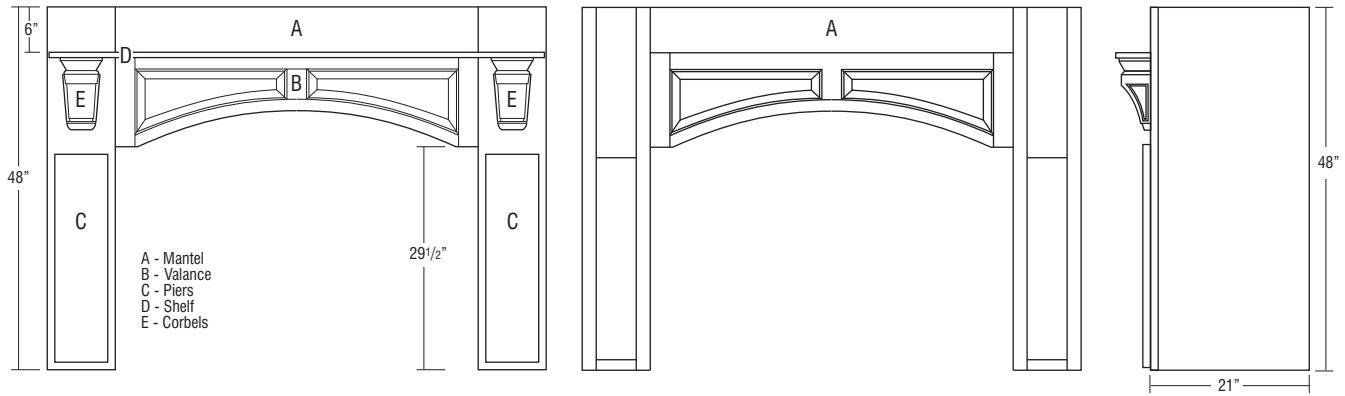

• Recommended clearance of 7"-12" on each side of gas burner to combustible surface, 3"-6" from non-combustible surfaces including the backplash surface and 30" from the vent. Reference local codes before installation.

		Hearth Width					
		48"	54"	60"	66"	72"	78"
<b>48" High</b>	Pier (left)	HP94821L or HPP94821	HP94821L or HPP94821	HP94821L or HPP94821	HP94821L or HPP94821	HP94821L or HPP94821	HP94821L or HPP94821
	Pier (right)	HP94821R or HPP94821	HP94821R or HPP94821	HP94821R or HPP94821	HP94821R or HPP94821	HP94821R or HPP94821	HP94821R or HPP94821
	Mantel	HM306	HM366	HM426	HM486	HM546	HM606
	Valance	JRPV30 or JRCPV30	JRPV36 or JRCPV36	JRPV42 or JRCPV42	JRPV48 or JRCPV48	JRPV54 or JRCPV54	JRPV60 or JRCPV60
	Corbel (2 Qty)	CORBELMIS9 or CORBELSCR9	CORBELMIS9 or CORBELSCR9	CORBELMIS9 or CORBELSCR9	CORBELMIS9 or CORBELSCR9	CORBELMIS9 or CORBELSCR9	CORBELMIS9 or CORBELSCR9
	Shelf	HS48	HS54	HS60	HS66	HS72	HS78
	Hood Liner	HL30	HL36	HL42	HL48	HL54	HL60
	Blower	All blowers are compatible					

**HEARTH, 51" HIGH, 21" DEEP**

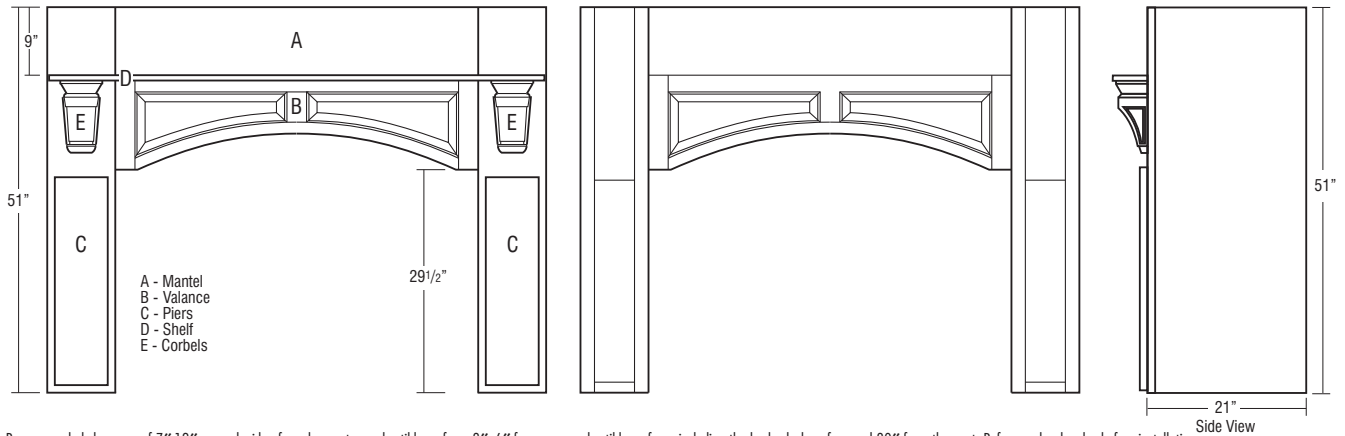

• Recommended clearance of 7"-12" on each side of gas burner to combustible surface, 3"-6" from non-combustible surfaces including the backplash surface and 30" from the vent. Reference local codes before installation.

		Hearth Width					
		48"	54"	60"	66"	72"	78"
<b>51" High</b>	Pier (left)	HP95121L or HPP95121	HP95121L or HPP95121	HP95121L or HPP95121	HP95121L or HPP95121	HP95121L or HPP95121	HP95121L or HPP95121
	Pier (right)	HP95121R or HPP95121	HP95121R or HPP95121	HP95121R or HPP95121	HP95121R or HPP95121	HP95121R or HPP95121	HP95121R or HPP95121
	Mantel	HM309	HM369	HM429	HM489	HM549	HM609
	Valance	JRPV30 or JRCPV30	JRPV36 or JRCPV36	JRPV42 or JRCPV42	JRPV48 or JRCPV48	JRPV54 or JRCPV54	JRPV60 or JRCPV60
	Corbel (2 Qty)	CORBELMIS9 or CORBELSCR9	CORBELMIS9 or CORBELSCR9	CORBELMIS9 or CORBELSCR9	CORBELMIS9 or CORBELSCR9	CORBELMIS9 or CORBELSCR9	CORBELMIS9 or CORBELSCR9
	Shelf	HS48	HS54	HS60	HS66	HS72	HS78
	Hood Liner	HL30	HL36	HL42	HL48	HL54	HL60
	Blower	All blowers are compatible					



**HEARTH, 54" HIGH, 21" DEEP**

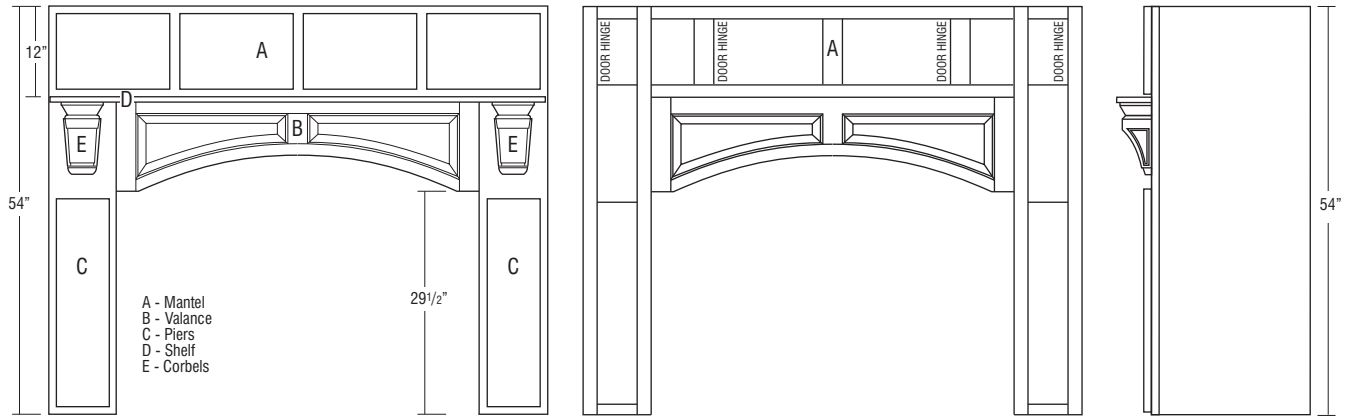

• Recommended clearance of 7"-12" on each side of gas burner to combustible surface, 3"-6" from non-combustible surfaces including the backsplash surface and 30" from the vent. Reference local codes before installation. — 21"

		Hearth Width					
		48"	54"	60"	66"	72"	78"
<b>54" High</b>	Pier (left)	HP95421L or HPP95421	HP95421L or HPP95421	HP95421L or HPP95421	HP95421L or HPP95421	HP95421L or HPP95421	HP95421L or HPP95421
	Pier (right)	HP95421R or HPP95421	HP95421R or HPP95421	HP95421R or HPP95421	HP95421R or HPP95421	HP95421R or HPP95421	HP95421R or HPP95421
	Mantel	HM3012	HM3612	HM4212	HM4812	HM5412	HM6012
	Valance	JRPV30 or JRCPV30	JRPV36 or JRCPV36	JRPV42 or JRCPV42	JRPV48 or JRCPV48	JRPV54 or JRCPV54	JRPV60 or JRCPV60
	Corbel (2 Qty)	CORBELMIS9 or CORBELSCR9	CORBELMIS9 or CORBELSCR9	CORBELMIS9 or CORBELSCR9	CORBELMIS9 or CORBELSCR9	CORBELMIS9 or CORBELSCR9	CORBELMIS9 or CORBELSCR9
	Shelf	HS48	HS54	HS60	HS66	HS72	HS78
	Hood Liner	HL30	HL36	HL42	HL48	HL54	HL60
	Blower	All blowers are compatible					

**HEARTH, 57" HIGH, 21" DEEP**

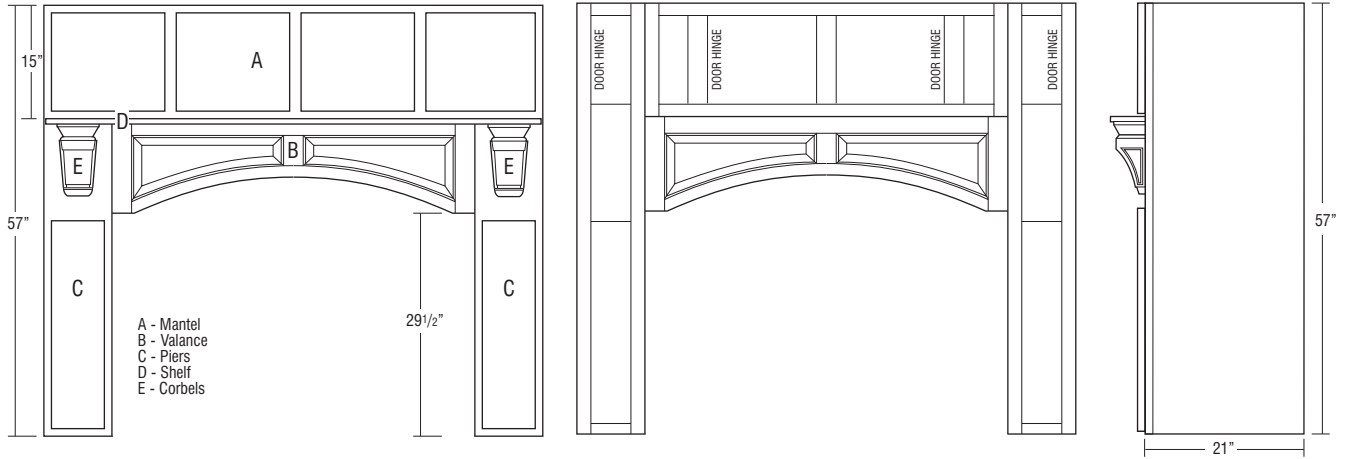

• Recommended clearance of 7"-12" on each side of gas burner to combustible surface, 3"-6" from non-combustible surfaces including the backsplash surface and 30" from the vent. Reference local codes before installation.

		Hearth Width					
		48"	54"	60"	66"	72"	78"
57" High	Pier (left)	HP95721L or HPP95721	HP95721L or HPP95721	HP95721L or HPP95721	HP95721L or HPP95721	HP95721L or HPP95721	HP95721L or HPP95721
	Pier (right)	HP95721R or HPP95721	HP95721R or HPP95721	HP95721R or HPP95721	HP95721R or HPP95721	HP95721R or HPP95721	HP95721R or HPP95721
	Mantel	HM3015	HM3615	HM4215	HM4815	HM5415	HM6015
	Valance	JRPV30 or JRCPV30	JRPV36 or JRCPV36	JRPV42 or JRCPV42	JRPV48 or JRCPV48	JRPV54 or JRCPV54	JRPV60 or JRCPV60
	Corbel (2 Qty)	CORBELMIS9 or CORBELSCR9	CORBELMIS9 or CORBELSCR9	CORBELMIS9 or CORBELSCR9	CORBELMIS9 or CORBELSCR9	CORBELMIS9 or CORBELSCR9	CORBELMIS9 or CORBELSCR9
	Shelf	HS48	HS54	HS60	HS66	HS72	HS78
	Hood Liner	HL30	HL36	HL42	HL48	HL54	HL60
	Blower	All blowers are compatible					

**HEARTH, 60" HIGH, 21" DEEP**

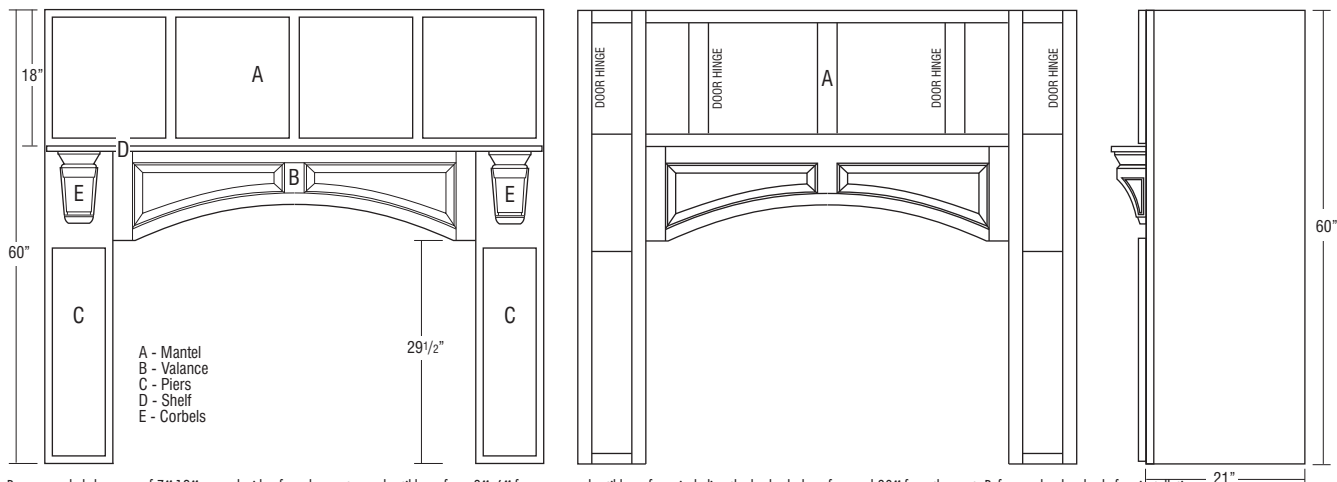

• Recommended clearance of 7"-12" on each side of gas burner to combustible surface, 3"-6" from non-combustible surfaces including the backsplash surface and 30" from the vent. Reference local codes before installation.

		Hearth Width					
		48"	54"	60"	66"	72"	78"
60" High	Pier (left)	HP96021L or HPP96021	HP96021L or HPP96021	HP96021L or HPP96021	HP96021L or HPP96021	HP96021L or HPP96021	HP96021L or HPP96021
	Pier (right)	HP96021R or HPP96021	HP96021R or HPP96021	HP96021R or HPP96021	HP96021R or HPP96021	HP96021R or HPP96021	HP96021R or HPP96021
	Mantel	HM3018	HM3618	HM4218	HM4818	HM5418	HM6018
	Valance	JRPV30 or JRCPV30	JRPV36 or JRCPV36	JRPV42 or JRCPV42	JRPV48 or JRCPV48	JRPV54 or JRCPV54	JRPV60 or JRCPV60
	Corbel (2 Qty)	CORBELMIS9 or CORBELSCR9	CORBELMIS9 or CORBELSCR9	CORBELMIS9 or CORBELSCR9	CORBELMIS9 or CORBELSCR9	CORBELMIS9 or CORBELSCR9	CORBELMIS9 or CORBELSCR9
	Shelf	HS48	HS54	HS60	HS66	HS72	HS78
	Hood Liner	HL30	HL36	HL42	HL48	HL54	HL60
	Blower	All blowers are compatible					

**HEARTH (FLOATING), 36" HIGH, 21" DEEP**

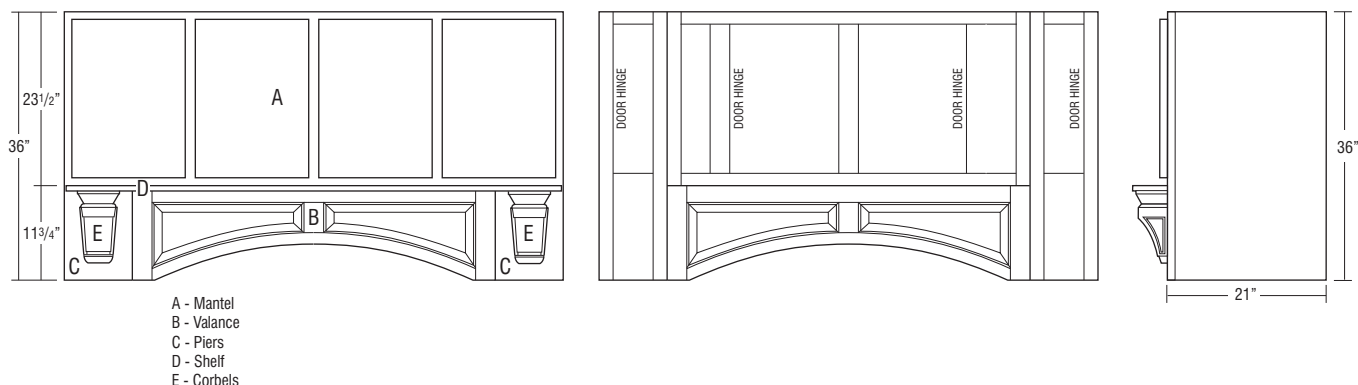

• Cabinets must be fully supported by screws in a structural member in the ceiling or soffit, and into adjacent cabinets.

		Hearth Width					
		48"	54"	60"	66"	72"	78"
36" High	Pier (left)	HP93621	HP93621	HP93621	HP93621	HP93621	HP93621
	Pier (right)	HP93621	HP93621	HP93621	HP93621	HP93621	HP93621
	Mantel	HM3023.5	HM3623.5	HM4223.5	HM4823.5	HM5423.5	HM6023.5
	Valance	JRPV30 or JRCPV30	JRPV36 or JRCPV36	JRPV42 or JRCPV42	JRPV48 or JRCPV48	JRPV54 or JRCPV54	JRPV60 or JRCPV60
	Corbel (2 Qty)	CORBELMIS9 or CORBELSCR9	CORBELMIS9 or CORBELSCR9	CORBELMIS9 or CORBELSCR9	CORBELMIS9 or CORBELSCR9	CORBELMIS9 or CORBELSCR9	CORBELMIS9 or CORBELSCR9
	Shelf	HS48	HS54	HS60	HS66	HS72	HS78
	Hood Liner	HL30	HL36	HL42	HL48	HL54	HL60
	Blower	All blowers are compatible					

**HEARTH PIER, 9" WIDE, 36" HIGH**

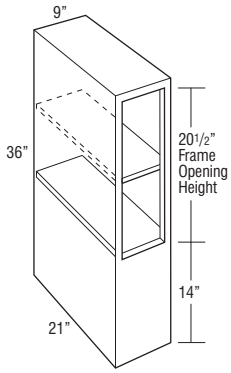

Model	Cubic Feet
HP93621	5.7

- Matching Interior Plywood (MIP) standard.
- Designed for use with a floating hearth application.
- Not available in Hickory door styles.
- Recommended for use with 24" high Mantel and 9" high Corbels.

**Custom Modifications**

ADDTK	AUTHL AUTHR	CBO	CCO	CFNTO	CFRMO	CND	EXBKL EXBKR	EXL EXR	FB	FFDL FFDR	FPEB STD
		STD		•	•		•				
ID	INVFRM	MIP	P	PFINBTMB	RD	TD	TVRV TVRFV TVRVV	WLI			
•		STD			•						

**Construction Upgrades**

APC	PE

**Door Options**

ALF	CG	CG.BTM	CG.TOP	DPSRR	MD	MD.BTM	MD.TOP	MFO

**HEARTH PIER, 9" WIDE, 21" DEEP,  
48", 51", 54", 57", or 60" HIGH**

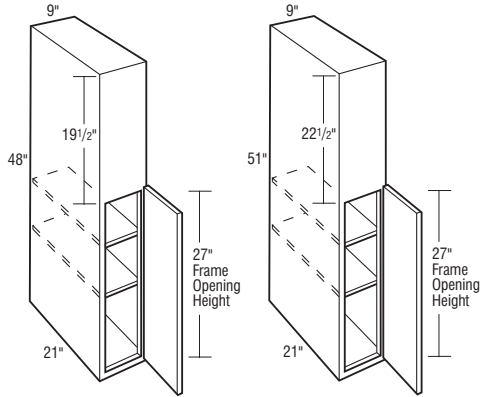

HP95121 L or R

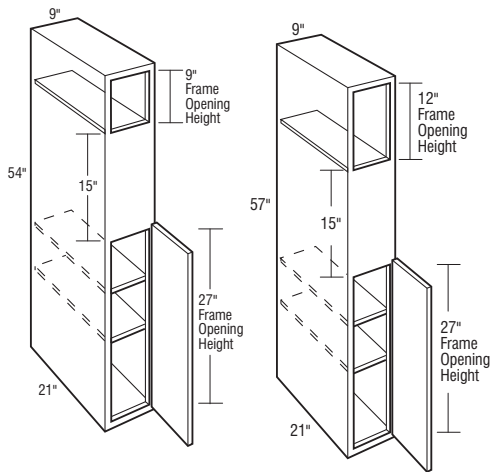

HP95421 L or R

HP95721 L or R

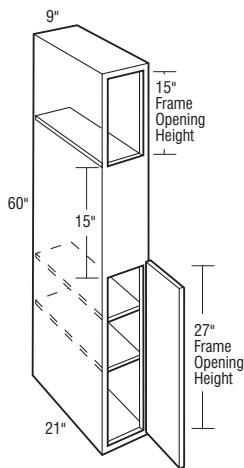

HP96021 L or R

Model	Cubic Feet
HP94821 L or R	7.7
HP95121 L or R	7.8
HP95421 L or R	8.6
HP95721 L or R	8.7
HP96021 L or R	9.5

- When ordered in Arch door styles, door will be Square.
- Not available in Hickory door styles.
- Recommended for use with hearth mantels and 9" high corbels, see pages 166-169 for mantel height recommendation.

**Custom Modifications**

	ADDTK	AUTHL AUTHR	CBO	CCO	CFNT0	CFRMO	CND	EXBKL EXBKR	EXL EXR	FB	FFDL FFDR	FPEB
			•	•	•	•		•				STD
ID	INVERM	MIP	P	PFINTMB	RD	TD	TVRAV TVRFV TVRVV	WLI				
•		•			•			•				

**Construction Upgrades**

APC	PE
•	

**Door Options**

ALF	CG	CG.BTM	CG.TOP	DPSRR	MD	MD.BTM	MD.TOP	MFO
				•				

**HEARTH PIER with PULL-OUT,  
9" WIDE, 21" DEEP,  
48", 51", 54", 57", or 60" HIGH**

L O G I X

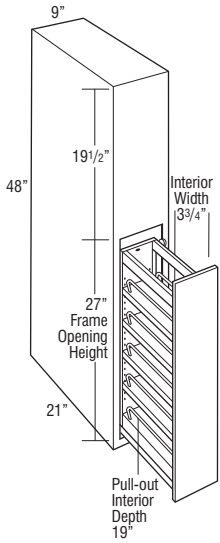

HPP94821

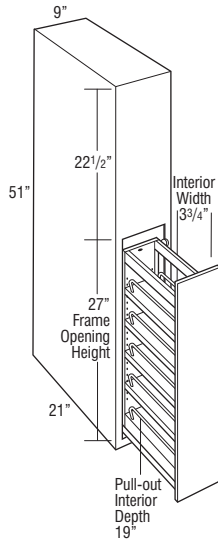

HPP95121

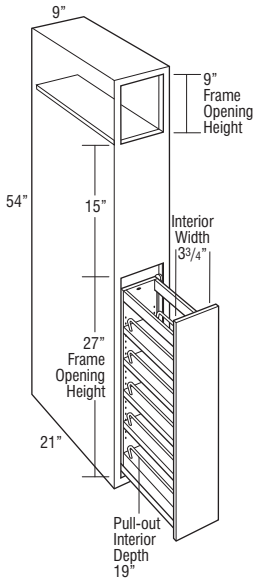

HPP95421

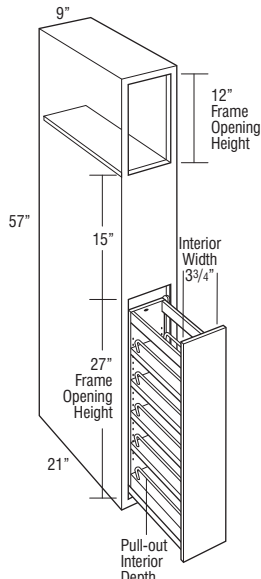

HPP95721

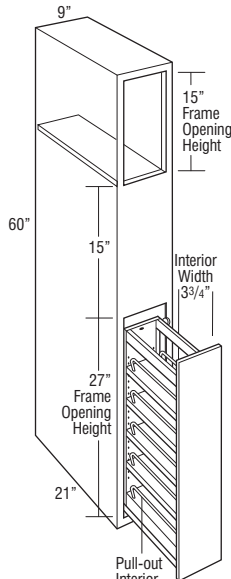

HPP96021

Model	Cubic Feet
HPP94821	7.7
HPP95121	7.7
HPP95421	7.7
HPP95721	8.7
HPP96021	8.6

- Includes a natural finish full extension wood pull-out with adjustable shelves and chrome rail sides.
- For full access from both sides of unit, do not install against a wall or next to deeper appliances and cabinets.
- When ordered in Arch door styles, door will be Square.
- Not available in Hickory door styles.
- Recommended for use with hearth mantels and 9" high corbels, see pages 166-169 for mantel height recommendation.

**Custom Modifications**

ADDTK	AUTHL AUTHR	CBO	CCO	CFNTO	CFRMO	CND	EXBKL EXBKR	EXL EXR	FB	FFDL FFDR	FPEB
		•	•	•	•		•				STD
ID	INVFRM	MIP	P	PFNBTAB	RD	TD	TVRAV TVRFV TVRVV	WLI			
•		•						•			

**Construction Upgrades**

APC	PE
•	

**Door Options**

ALF	CG	CG.BTM	CG.TOP	DPSRR	MD	MD.BTM	MD.TOP	MFO
				•				

**HEARTH MANTEL, 6" or 9" HIGH**

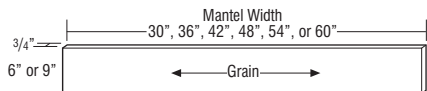

Model	Cubic Feet
HM306	2.7
HM366	2.7
HM426	2.7
HM486	2.7
HM546	2.7
HM606	2.7
HM309	5.1
HM369	5.1
HM429	5.1
HM489	5.1
HM549	5.1
HM609	5.1

- Recommended for use with 48" or 51" high Hearth Piers and same width Raised or Recessed Panel Arched Valance (see page 166).
- Not available in Hickory door styles.

MODIFICATIONS
No modifications available for these products.

**Finish Techniques**

Distressing	Heirlooming
•	•

**HEARTH MANTEL, 12" HIGH**

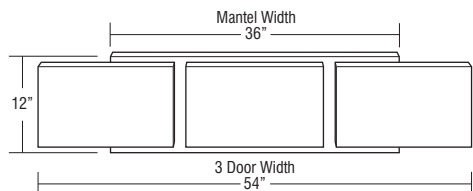
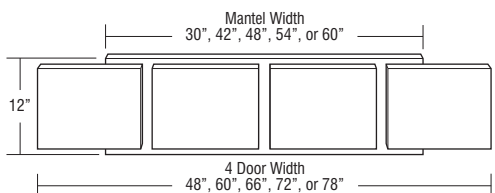

HM3012	7.5
HM3612	7.5
HM4212	7.5
HM4812	7.5
HM5412	7.5
HM6012	7.5

- Recommended for use with 54" high Hearth Piers and same width Raised or Recessed Panel Arched Valance (see page 167).
- Not available in Hickory door styles.
- Doors for Hearth Mantel are included. Field installation required for attachment of outer doors to Hearth Piers.

MODIFICATIONS
No modifications available for these products.

**Door Options**

ALF	CG	CG.BTM	CG.TOP	DPSRR	MD	MD.BTM	MD.TOP	MFO
				•				•

**Finish Techniques**

Distressing	Heirlooming
•	•

**HEARTH MANTEL, 15" HIGH**

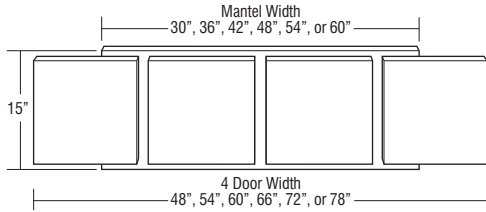

Model	Cubic Feet
HM3015	2.0
HM3615	2.3
HM4215	2.7
HM4815	3.1
HM5415	3.4
HM6015	3.8

- Recommended for use with 57" high Hearth Piers and same width Raised or Recessed Panel Arched Valance (see page 168).
- Not available in Hickory door styles.
- Doors for Hearth Mantel are included. Field installation required for attachment of outer doors to Hearth Piers.

MODIFICATIONS
No modifications available for these products.

**Door Options**

ALF	CG	CG.BTM	CG.TOP	DPSRR	MD	MD.BTM	MD.TOP	MFO
				•				•

**Finish Techniques**

Distressing	Heirlooming
•	•

**HEARTH MANTEL, 18" HIGH**

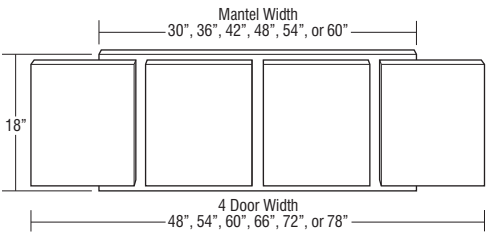

HM3018	7.5
HM3618	7.5
HM4218	7.5
HM4818	7.5
HM5418	7.5
HM6018	7.5

- Recommended for use with 60" high Hearth Piers and same width Raised or Recessed Panel Arched Valance (see page 169).
- Not available in Hickory door styles.
- Doors for Hearth Mantel are included. Field installation required for attachment of outer doors to Hearth Piers.

MODIFICATIONS
No modifications available for these products.

**Door Options**

ALF	CG	CG.BTM	CG.TOP	DPSRR	MD	MD.BTM	MD.TOP	MFO
				•				•

**Finish Techniques**

Distressing	Heirlooming
•	•

**HEARTH MANTEL, 23 1/2" HIGH**

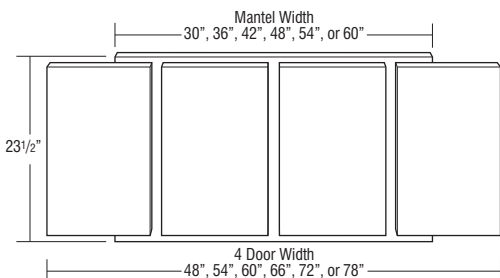

HM3023.5	1.3
HM3623.5	1.6
HM4223.5	1.8
HM4823.5	2.1
HM5423.5	2.3
HM6023.5	2.6

- Recommended for use with 36" high Hearth Piers and same width Raised or Recessed Panel Arched Valance (see page 169).
- Not available in Hickory door styles.
- Doors for Hearth Mantel are included. Field installation required for attachment of outer doors to Hearth Piers.

MODIFICATIONS
No modifications available for these products.

**Door Options**

ALF	CG	CG.BTM	CG.TOP	DPSRR	MD	MD.BTM	MD.TOP	MFO
				•				•

**Finish Techniques**

Distressing	Heirlooming
•	•



**HEARTH SHELF, 4 1/2" DEEP**

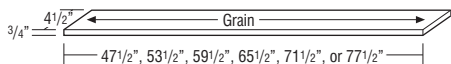

Model	Cubic Feet
HS48	2.7
HS54	2.7
HS60	2.7
HS66	2.7
HS72	2.7
HS78	2.7

- Shelves will install on top of corbels and will slightly overlay the Raised or Recessed Panel Arched Valance.
- Shelf width should match the overall hearth width (pier width + Mantel/valance width).
- Actual shelf width is 1/2" shorter than the dimension in the product code.
- Shelf finished on one long edge, two short edges, top, and bottom.
- Not available in Hickory.
- If ordered with Heirlooming Technique, will not feature sand-through characteristics.

MODIFICATIONS
No modifications available for these products.

**HEARTH LINER**

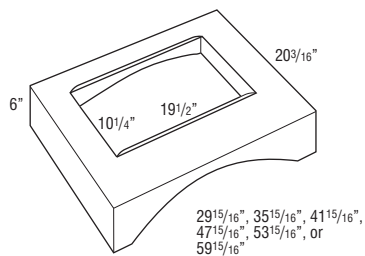

HL30	3.5
HL36	4.1
HL42	4.7
HL48	5.4
HL54	6.0
HL60	6.6

- Liner is metallic silver.
- Compatible with all blowers.
- Mounts to wall and adjoining cabinets.
- Recommended for use with Raised or Recessed Panel Arched Valance.

MODIFICATIONS
No modifications available for these products.

# Diamond®

## DISTINCTION™ SERIES

### BASE CABINET NOMENCLATURE

All Base Cabinets are 34 1/2" high and 24" deep unless otherwise noted.

**B24**

Cabinet Type      Cabinet Width

All Base Cabinets are available in Square Cabinet Styles only.

### TOEKICKS

Base Cabinets are shipped with an unfinished toekick. Finished toekicks in matching wood veneer or laminate must be ordered separately and field installed.

### MODIFICATIONS GRID KEY

- Available
- STD Standard on these cabinets
- L O G I X Logix® Organization Cabinet



5 Day Express Response Item

### CUSTOM MODIFICATIONS

Mod.	Description	Mod.	Description	Mod.	Description
AUTHL	Authentic End - Left	EXL	Extended Sisle - Left	P	Peninsula
AUTHR	Authentic End - Right	EXR	Extended Sisle - Right	PTOWB	Push to Open Wastebasket
CBO	Cabinet Box Only	FB	Finished Ends	RD	Reduced Depth
CCO	Cabinet Case Only	FD	Full Depth Shelf	RECTKALL	Recessed Island Toekick
CFNTO	Cabinet Front Only	FFDL	Face Frame and Door on End - Left	RECTKBK	Recessed Toekick - Back
CFP	Cabinet False Panel	FFDR	Face Frame and Door on End - Right	RECTKL	Recessed Toekick - Left
CFRMO	Cabinet Frame Only	FFDR	Face Frame and Door on End - Right	RECTKR	Recessed Toekick - Right
CMAT	CabMat™	FPEB	Furniture Finished Plywood Ends	RT	Installed Roll Tray
CND	Cabinet with No Door, with Drawer	FTK	Flush Toekick	SCPDRW	Scooped Drawer
DRT	Deep Roll Tray	FTKAV	Flush Toekick Arch	TD	Tray Dividers
DRWPWR	PowerGlide™ Compact Drawer Outlet	FTKAV	Flush Toekick Arch	TOTSS	Tilt-out Tray, Stainless Steel
DRWSEC	Biometric Secured Drawer	FTKAV	Flush Toekick Arch	TOTSS	Tilt-out Tray, Stainless Steel Slim
DRWTK	Toekick Drawer	ID	Increased Depth	TVRAV	Valance Top Rail, Arch
EXBKL	End Extended Back - Left	INVFRM	Inverted Frame	TVRFV	Valance Top Rail, Furniture
EXBKR	End Extended Back - Right	LTI	Light Installed Battery Strip	TVRVV	Valance Top Rail, Straight
		MIP	Matching Interior Plywood	VTK	Void Toekick
				WLI	White Laminate Interior

### CONSTRUCTION UPGRADES

Mod.	Description
APC	All-plywood Construction
ET	EasyTrax™
PE	Plywood Ends

### DOOR OPTIONS

Mod.	Description
CG	Cut-for-glass Doors
DPSRR	Door Panel - Solid Reverse Raised

176

BASE CABINETS

### BASE SINGLE DOOR

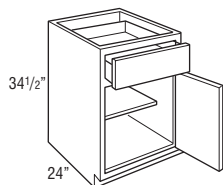

B9 L or R  
B12 L or R  
B15 L or R  
B18 L or R  
B21 L or R  
B24 L or R

Model	Cubic Feet
B9 L or R	6.1
B12 L or R	7.8
B15 L or R	9.4
B18 L or R	11.1
B21 L or R	12.8
B24 L or R	14.4

- Adjustable 15" deep shelves.

### Custom Modifications

AUTHL	AUTHR	CBO	CCO	CFNTO	CFP	CFRMO	CMAT	CND	DRT	DRWPWR	DRWSEC	DRWTK	EXBKL	EXBKR
•	•	•	•	•	•	•		•		•*	•*	•*	•	
EXL	EXR	FB	FD	FFDL	FFDR	FPEB	FTKAV	FTKAV	ID	INVFRM	LTI	MIP	P	PTOWB
•	•	•	•	•	•	•	•+		•	•+		•	•▲	
RD	RECTKALL	RECTKBK	RECTKL	RECTKR	RT	SCPDRW	TD	TOTSS	TVRAV	TVRFV	TVRVV	VTK	WLI	
•	•	•	•	•▲	•				•	•		•	•	

\*Not available on 9", 12", and 15" wide    +Not available on 9" and 12" wide    ▲Not available on 9" wide

†Not available on 9", 12", 15", and 18" wide

### Construction Upgrades

APC	ET	PE
•		•

### Door Options

CG	DPSRR
•†	•

†Not available on 9" wide

### BASE PAPER TOWEL CABINET

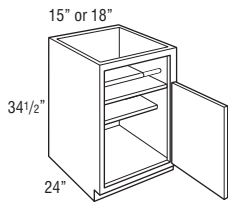

Model	Cubic Feet
<b>BPT15 L or R</b>	9.4
<b>BPT18 L or R</b>	11.1

- Upper section of cabinet features an open cubby area with veneer finished interior sides and fixed shelf, a gray tension rod for easy removal, and a storage area behind the paper towel roll for an additional three to four paper towel rolls. Maximum paper towel diameter is 6".
- Cabinet back and lower section of cabinet has standard interior.
- Adjustable 15" deep shelf.

#### Custom Modifications

AUTHL AUTHR	CBO	CCO	CFNTO	CFP	CFRMO	CMAT	CND	DRT	DRWPWR	DRWSEC	DRWTK	EXBKL EXBKR
•	•	•									•*	•
EXL EXR	FB	FD	FFDL FFDR	FPEB	FTK	FTKAV FTKFV	ID	INVFRM	LTI	MIP	P	PTOWB
		•		•	•	•			•	•		
RD	RECTKALL RECTKBK	RECTKL RECTKR	RT	SCPDRW	TD	TOTSS TOTSSS	TVRAV TVRFV TVRVV	VTK	WLI			
•	•	•	•					•	•			

\*Not available on 15" wide

#### Construction Upgrades

APC	ET	PE
•		•

#### Door Options

CG	DPSRR
	•

### BASE DOUBLE DOOR

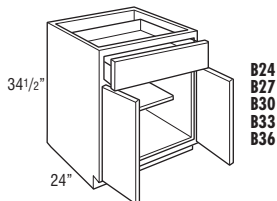

**B24**  
**B27**  
**B30**  
**B33**  
**B36**

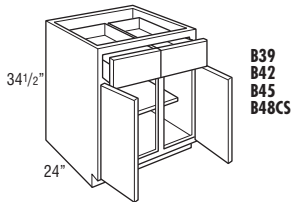

**B39**  
**B42**  
**B45**  
**B48CS**

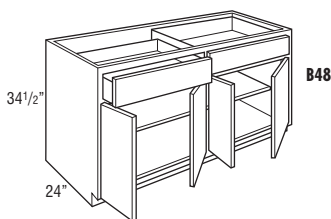

**B48**

<b>B24</b>	14.4
<b>B27</b>	16.1
<b>B30</b>	17.7
<b>B33</b>	19.6
<b>B36</b>	21.1
<b>B39</b>	22.7
<b>B42</b>	24.4
<b>B45</b>	25.8
<b>B48CS</b>	27.7
<b>B48</b>	27.7

- Adjustable 15" deep shelves.

#### Custom Modifications

AUTHL AUTHR	CBO	CCO	CFNTO	CFP	CFRMO	CMAT	CND	DRT	DRWPWR	DRWSEC	DRWTK	EXBKL EXBKR
•	•	•	•	•	•		•		•	•*	•*	•
EXL EXR	FB	FD	FFDL FFDR	FPEB	FTK	FTKAV FTKFV	ID	INVFRM	LTI	MIP	P	PTOWB
•	•	•	•	•	•	•		•	•	•	•	
RD	RECTKALL RECTKBK	RECTKL RECTKR	RT	SCPDRW	TD	TOTSS TOTSSS	TVRAV TVRFV TVRVV	VTK	WLI			
•	•	•	•	•				•	•			

\*Available only on 24", 42", and 48" wide \*Not available on 39", 42", 45", and 48" wide

#### Construction Upgrades

APC	ET	PE
•		•

#### Door Options

CG	DPSRR
•	•

**BASE with CUTLERY INSERT WOOD ORGANIZER**

LOGIX

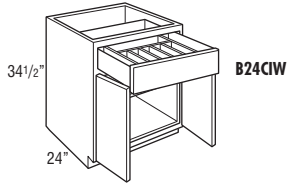
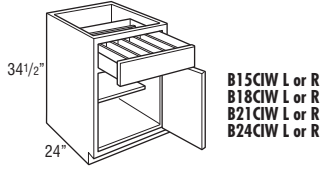

Model	Cubic Feet
B15CIW L or R	9.4
B18CIW L or R	11.1
B21CIW L or R	12.8
B24CIW L or R	14.4
<hr/>	
<b>B24CIW</b>	<b>14.4</b>

- Adjustable 15" deep shelf.
- Cutlery Insert Wood Organizer is also available as an accessory. See page 418.

**Custom Modifications**

AUTHL AUTHR	CBO	CCO	CFNT0	CFP	CFRMO	CMAT	CND	DRT	DRWPWR	DRWSEC	DRWTK	EXBKL EXBKR
•	•	•	•	•	•		•				•*	•
EXL EXR	FB	FD	FFDL FFDR	FPEB	FTK	FTKAV FTKFV	ID	INVFRM	LTI	MIP	P	PTOWB
•	•	•	•	•	•	•			•	•	•	
RD	RECTKALL RECTKBK	RECTKL RECTKR	RT	SCPDWR	TD	TOTSS TOTSSS	TVRAV TVRFV TVRVV	VTK	WLI			
	•	•	•					•	•			

\*Not available on 15" wide

**Construction Upgrades**

APC	ET	PE
•		•

**Door Options**

CG	DPSRR
•	•

**BASE with WOOD TIERED CUTLERY DIVIDER DRAWER**

LOGIX

15", 18", 21", or 24"

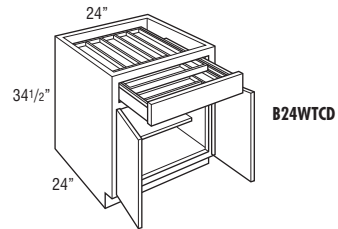
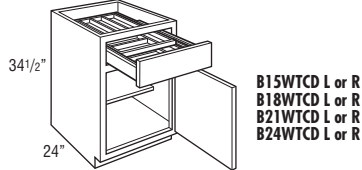

B15WTCD L or R	9.4
B18WTCD L or R	11.1
B21WTCD L or R	12.8
B24WTCD L or R	14.4
<hr/>	
<b>B24WTCD</b>	<b>14.4</b>

- Adjustable 15" deep shelf.
- Exterior WTCD drawer box height is 3 3/4", interior height of top and bottom tier is 1 3/8".
- Wood Tiered Cutlery Divider Drawer is also available as an accessory. See page 418.

**Custom Modifications**

AUTHL AUTHR	CBO	CCO	CFNT0	CFP	CFRMO	CMAT	CND	DRT	DRWPWR	DRWSEC	DRWTK	EXBKL EXBKR
•	•	•	•	•	•		•				•*	•
EXL EXR	FB	FD	FFDL FFDR	FPEB	FTK	FTKAV FTKFV	ID	INVFRM	LTI	MIP	P	PTOWB
•	•	•	•	•	•	•			•	•	•	
RD	RECTKALL RECTKBK	RECTKL RECTKR	RT	SCPDWR	TD	TOTSS TOTSSS	TVRAV TVRFV TVRVV	VTK	WLI			
	•	•	•					•	•			

\*Not available on 15" wide

**Construction Upgrades**

APC	ET	PE
•		•

**Door Options**

CG	DPSRR
•	•

**BASE with WOOD TIERED K-CUP\* DRAWER**

L G I X

Model	Cubic Feet
<b>B18KCUP L or R</b>	11.1

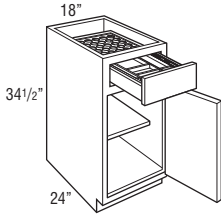

- Adjustable 15" deep shelf.
  - Holds 40 K-Cups.
  - Exterior Wood Tiered K-Cup drawer box height is 3 3/4", interior height of top tier is 1 5/8", and interior height of bottom tier is 1 3/8".
  - The Wood Tiered K-Cup Drawer is compatible with K-Cup pods only.
  - Wood Tiered K-Cup Drawer is also available as an accessory. See page 419.
- \*K-Cup is a registered trademark of Keurig Green Mountain, Inc.

**Custom Modifications**

AUTHL AUTHR	CBO	CCO	CFNTD	CFP	CFRMO	CMAT	CND	DRT	DRWPWR	DRWSEC	DRWTK	EXBKL EXBKR
•	•	•	•	•	•		•				•	•
EXL EXR	FB	FD	FFDL FFDR	FPEB	FTK	FTKAV FTKFV	ID	INVFRM	LTl	MIP	P	PTOWB
•	•	•	•	•	•	•			•	•	•	
RD	RECTKALL RECTKBK	RECTKL RECTKR	RT	SCPDRW	TD	TOTSS TOTSSS	TVRAV TVRFV TVRVV	VTK	WLI			
•	•	•	•					•	•			

**Construction Upgrades**

APC	ET	PE
•		•

**Door Options**

CG	DPSRR
•	•

**FULL HEIGHT BASE SINGLE DOOR, 6" WIDE**

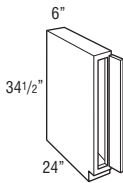

Model	Cubic Feet
<b>B6FH L or R</b>	4.1

- Frame opening is 3" wide.
- Cabinet has a full top panel.
- Utilizes a 5 1/2" wide overlay filler as a hinged door for full and partial overlay styles.
- When FFDL or FFDR modification is selected, the VTK modification will automatically be selected.

**Custom Modifications**

AUTHL AUTHR	CBO	CCO	CFNTD	CFP	CFRMO	CMAT	CND	DRT	DRWPWR	DRWSEC	DRWTK	EXBKL EXBKR
		•	•		•		•					•
EXL EXR	FB	FD	FFDL FFDR	FPEB	FTK	FTKAV FTKFV	ID	INVFRM	LTl	MIP	P	PTOWB
•	•		•*	•	•		•			•	•	
RD	RECTKALL RECTKBK	RECTKL RECTKR	RT	SCPDRW	TD	TOTSS TOTSSS	TVRAV TVRFV TVRVV	VTK	WLI			
•								•	•			

\*Includes VTK

**Construction Upgrades**

APC	ET	PE
•		•

**Door Options**

CG	DPSRR

**FULL HEIGHT BASE SINGLE DOOR**

9", 12", 15", 18", 21", or 24"

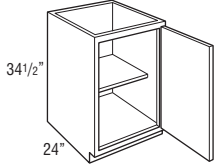

B9FH L or R  
B12FH L or R  
B15FH L or R  
B18FH L or R  
B21FH L or R  
B24FH L or R

Model	Cubic Feet
B9FH L or R	6.1
B12FH L or R	7.8
B15FH L or R	9.4
B18FH L or R	11.1
B21FH L or R	12.8
B24FH L or R	14.4

- Adjustable 15" deep shelf.

**Custom Modifications**

AUTHL AUTHR	CBO	CCO	CFNT0	CFP	CFRMO	CMAT	CND	DRT	DRWPWR	DRWSEC	DRWTK	EXBKL EXBKR
•	•	•	•		•						•*	•
EXL EXR	FB	FD	FFDL FFDR	FPEB	FTK	FTKAV FTKFV	ID	INVFRM	LTI	MIP	P	PTOWB
•	•	•	•	•	•	•+	•		•+	•	•	
RD	RECTKALL RECTKBK	RECTKL RECTKR	RT	SCPDRW	TD	TOTSS TOTSSS	TAVRAV TVRFV TVRVV	VTK	WLI			
•	•▲	•▲	•▲		•			•	•			

\*Not available on 9", 12", and 15" wide    \*Not available on 9" and 12" wide    ▲Not available on 9" wide

**Construction Upgrades**

APC	ET	PE
•		•

**Door Options**

CG	DPSRR
•‡	•

‡Not available on 9" wide

**BASE PAPER TOWEL CABINET  
FULL HEIGHT**

15" or 18"

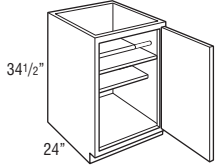

BPT15FH L or R	9.4
BPT18FH L or R	11.1

- Upper section of cabinet features an open cubby area with veneer finished interior sides and fixed shelf, a gray tension rod for easy removal, and a storage area behind the paper towel roll for an additional three to four paper towel rolls. Maximum paper towel diameter is 6".
- Cabinet back and lower section of cabinet has standard interior.
- Adjustable 15" deep shelf.

**Custom Modifications**

AUTHL AUTHR	CBO	CCO	CFNT0	CFP	CFRMO	CMAT	CND	DRT	DRWPWR	DRWSEC	DRWTK	EXBKL EXBKR
•	•	•									•*	•
EXL EXR	FB	FD	FFDL FFDR	FPEB	FTK	FTKAV FTKFV	ID	INVFRM	LTI	MIP	P	PTOWB
		•			•	•	•		•	•		
RD	RECTKALL RECTKBK	RECTKL RECTKR	RT	SCPDRW	TD	TOTSS TOTSSS	TAVRAV TVRFV TVRVV	VTK	WLI			
•	•	•	•					•	•			

\*Not available on 15" wide

**Construction Upgrades**

APC	ET	PE
•		•

**Door Options**

CG	DPSRR
	•

**FULL HEIGHT BASE SINGLE DOOR, 40 1/2" HIGH**

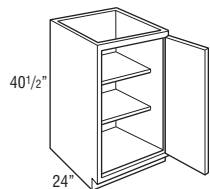

B940FH L or R  
 B1240FH L or R  
 B1540FH L or R  
 B1840FH L or R  
 B2140FH L or R  
 B2440FH L or R

Model	Cubic Feet
B940FH L or R	6.7
B1240FH L or R	8.6
B1540FH L or R	10.5
B1840FH L or R	12.3
B2140FH L or R	14.2
B2440FH L or R	16.1

• Two adjustable 15" deep shelves.

**Custom Modifications**

AUTHL AUTHR	CBO	CCO	CFNT0	CFP	CFRMO	CMAT	CND	DRT	DRWPWR	DRWSEC	DRWTK	EXBKL EXBKR
•	•	•	•		•						•*	•
EXL EXR	FB	FD	FFDL FFDR	FPEB	FTK	FTKAV FTKRV	ID	INVFRM	LTI	MIP	P	PTOWB
•	•	•	•	•	•	•*	•		•*	•	•	
RD	RECTKALL RECTKBK	RECTKL RECTKR	RT	SCPDRW	TD	TOTSS TOTSSS	TVRAV TVRFV TVRVV	VTK	WLI			
•	•▲	•▲	•					•	•			

\*Not available on 9", 12", and 15" wide \*Not available on 9" and 12" wide ▲Not available on 9" wide

**Construction Upgrades**

APC	ET	PE
•		•

**Door Options**

CG	DPSRR
•*	•

\*Not available on 9" wide

**FULL HEIGHT BASE DOUBLE DOOR**

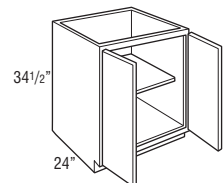

B24FH  
 B27FH  
 B30FH  
 B33FH  
 B36FH

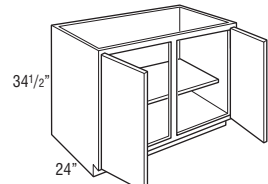

B39FH  
 B42FH  
 B45FH  
 B48FHCS

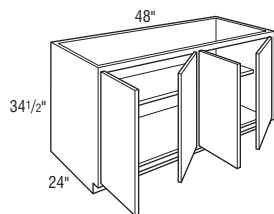

B48FH

B24FH	14.4
B27FH	16.1
B30FH	17.7
B33FH	19.6
B36FH	21.1
B39FH	22.7
B42FH	24.4
B45FH	25.8
B48FHCS	27.7
B48FH	27.7

• Adjustable 15" deep shelf.

**Custom Modifications**

AUTHL AUTHR	CBO	CCO	CFNT0	CFP	CFRMO	CMAT	CND	DRT	DRWPWR	DRWSEC	DRWTK	EXBKL EXBKR
•	•	•	•		•						•*	•
EXL EXR	FB	FD	FFDL FFDR	FPEB	FTK	FTKAV FTKRV	ID	INVFRM	LTI	MIP	P	PTOWB
•	•	•	•	•	•	•	•		•	•	•	
RD	RECTKALL RECTKBK	RECTKL RECTKR	RT	SCPDRW	TD	TOTSS TOTSSS	TVRAV TVRFV TVRVV	VTK	WLI			
•	•	•	•		•*			•	•			

\*Not available on 39", 42", 45", and 48" wide

**Construction Upgrades**

APC	ET	PE
•		•

**Door Options**

CG	DPSRR
•	•

**FULL HEIGHT BASE DOUBLE DOOR, 40 1/2" HIGH**

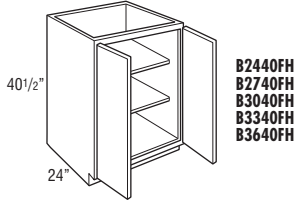

B2440FH  
B2740FH  
B3040FH  
B3340FH  
B3640FH

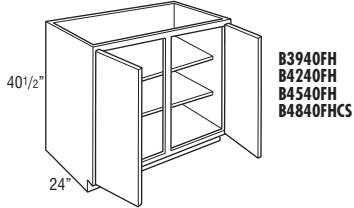

B3940FH  
B4240FH  
B4540FH  
B4840FHCS

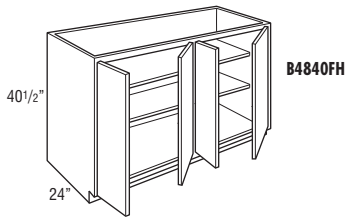

B4840FH

Model	Cubic Feet
B2440FH	16.1
B2740FH	18.0
B3040FH	19.8
B3340FH	21.7
B3640FH	23.6
B3940FH	25.4
B4240FH	27.3
B4540FH	25.8
B4840FHCS	31.1
B4840FH	31.1

- Two adjustable 15" deep shelves.

**Custom Modifications**

AUTHL AUTHR	CBO	CCO	CFNT0	CFP	CFRMO	CMAT	CND	DRT	DRWPWR	DRWSEC	DRWTK	EXBKL EXBKR
•	•	•	•		•						•*	•
EXL EXR	FB	FD	FFDL FFDR	FPEB	FTK	FTKAV FTKRV	ID	INVFRM	LTI	MIP	P	PTOWB
•	•	•	•	•	•	•	•			•	•	
RD	RECTKALL RECTKBK	RECTKL RECTKR	RT	SCPDRW	TD	TOTSS TOTSSS	TVRAV TVRFV TVRVV	VTK	WLI			
•	•	•	•					•	•			

\*Not available on 39", 42", 45", and 48" wide

**Construction Upgrades**

APC	ET	PE
•		•

**Door Options**

CG	DPSRR
•	•

**WALL BASE SINGLE DOOR**

12", 15", 18", 21", or 24"

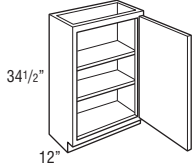

WB12 L or R	4.1
WB15 L or R	5.0
WB18 L or R	5.9
WB21 L or R	6.8
WB24 L or R	7.7

- Two full depth shelves.
- Will have the same shelf hole drill pattern as a base cabinet.

**Custom Modifications**

AUTHL AUTHR	CBO	CCO	CFNT0	CFP	CFRMO	CMAT	CND	DRT	DRWPWR	DRWSEC	DRWTK	EXBKL EXBKR
•	•	•	•		•							•
EXL EXR	FB	FD	FFDL FFDR	FPEB	FTK	FTKAV FTKRV	ID	INVFRM	LTI	MIP	P	PTOWB
•	•		•	•	•	•*	•			•	•	
RD	RECTKALL RECTKBK	RECTKL RECTKR	RT	SCPDRW	TD	TOTSS TOTSSS	TVRAV TVRFV TVRVV	VTK	WLI			
•	•*	•			•			•	•			

\*Not available on 12" wide

\*RECTKBK not available

**Construction Upgrades**

APC	ET	PE
•		•

**Door Options**

CG	DPSRR
•	•



**WALL BASE DOUBLE DOOR**

24", 27", 30", 33", or 36"

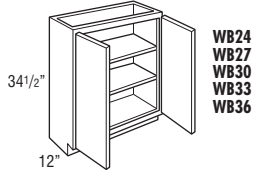

WB24  
WB27  
WB30  
WB33  
WB36

39", 42", 45", or 48"

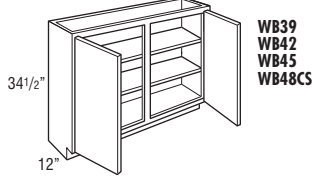

WB39  
WB42  
WB45  
WB48CS

48"

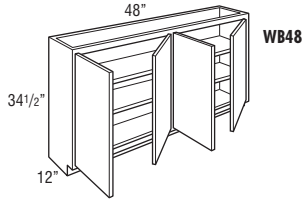

WB48

Model	Cubic Feet
WB24	7.7
WB27	8.6
WB30	9.5
WB33	10.4
WB36	11.2
WB39	12.1
WB42	13.0
WB45	13.9
WB48CS	14.8
WB48	14.8

- Two full depth shelves.
- Will have the same shelf hole drill pattern as a base cabinet.

**Custom Modifications**

AUTHL AUTHR	CBO	CCO	CFNT0	CFP	CFRMO	CMAT	CND	DRT	DRWPWR	DRWSEC	DRWTK	EXBKL EXBKR
•	•	•	•		•							•
EXL EXR	FB	FD	FFDL FFDR	FPEB	FTK	FTKAV FTKFV	ID	INVFRM	LTI	MIP	P	PTOWB
•	•		•	•	•	•				•	•	
RD	RECTKALL RECTKBK	RECTKL RECTKR	RT	SCPDRW	TD	TOTSS TOTSSS	TVRAV TVRFV TVRVV	VTK	WLI			
•	•*	•						•	•			

\*Not available on 39", 42", 45", and 48" wide \*RECTKBK not available

**Construction Upgrades**

APC	ET	PE
•		•

**Door Options**

CG	DPSRR
•	•

**BASE EASY ACCESS STORAGE**

L O G I X

15" or 18"

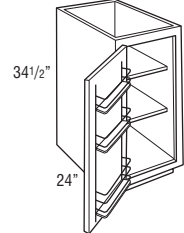

BEAS15 L or R  
BEAS18 L or R

Model	Cubic Feet
BEAS15 L or R	9.4
BEAS18 L or R	11.1

- Two adjustable 20" deep shelves.
- Door features a chrome and wood three-tiered rack.
- Door rack width is 9 3/8" on 15" wide cabinet and 12 3/8" on 18" wide cabinet.
- Door rack depth is 3 1/2".

**Custom Modifications**

AUTHL AUTHR	CBO	CCO	CFNT0	CFP	CFRMO	CMAT	CND	DRT	DRWPWR	DRWSEC	DRWTK	EXBKL EXBKR
•	•	•	•		•						•*	•
EXL EXR	FB	FD	FFDL FFDR	FPEB	FTK	FTKAV FTKFV	ID	INVFRM	LTI	MIP	P	PTOWB
•	•		•	•	•	•				•	•	
RD	RECTKALL RECTKBK	RECTKL RECTKR	RT	SCPDRW	TD	TOTSS TOTSSS	TVRAV TVRFV TVRVV	VTK	WLI			
•	•	•						•	•			

\*Not available on 15" wide

**Construction Upgrades**

APC	ET	PE
•		•

**Door Options**

CG	DPSRR
	•

30" SUPERCABINET™

LOGIX

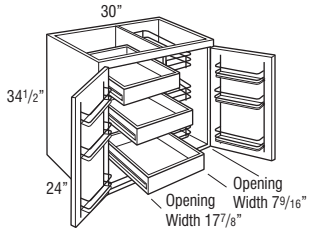

BSC30RP

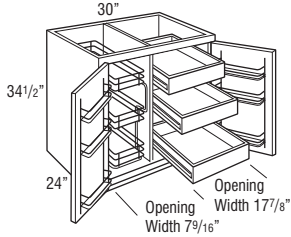

BSC30PR

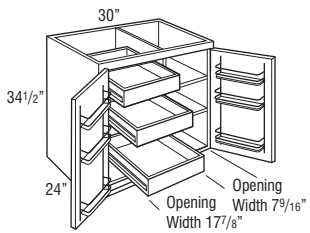

BSC30RS

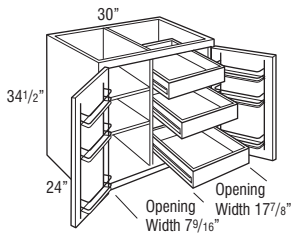

BSC30SR

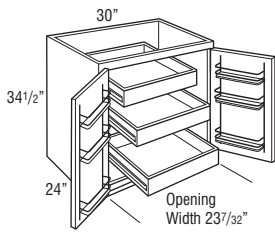

BSC30R

Model	Cubic Feet
BSC30RP	17.7
BSC30PR	17.7
BSC30RS	17.7
BSC30SR	17.7
BSC30R	17.7

- Nomenclature represents left to right order of interior components.  
Example: BSC30RS = Base SuperCabinet™ 30" Roll-out Shelves.
- Shelves are adjustable and 20" deep.
- Roll trays are Full Extension side-mounted.
- Cabinets utilize 170° hinge. For sufficient pull-out clearance, 12" of adjacent space is required for door to open 170° when installed near a wall or corner.
- Each door features a chrome and wood three-tiered rack.
- Door rack width is 9 3/8".
- Door rack depth is 3 1/2".
- Integrated soft-close hinge not included. Premium door mechanism installed.

Custom Modifications

AUTHL AUTHR	CBO	CCO	CFNT0	CFP	CFRMO	CMAT	CND	DRT	DRWPWR	DRWSEC	DRWTK	EXBKL EXBKR
•	•	•	•		•						•	•
EXL EXR	FB	FD	FFDL FFDR	FPEB	FTK	FTKAV FTKFV	ID	INVFRM	LTI	MIP	P	PTOWB
•	•			•	•	•				•		
RD	RECTKALL RECTKBK	RECTKL RECTKR	RT	SCPDRW	TD	TOTSS TOTSSS	TVRAV TVRFV TVRVV	VTK	WLI			
	•	•						•	•			

Construction Upgrades

APC	ET	PE
•		•

Door Options

CG	DPSRR
	•

### 30" SUPERCABINET™ VERSION 2

L O G I X

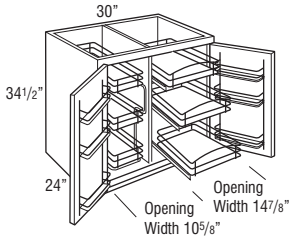

**BV2SC30PR**

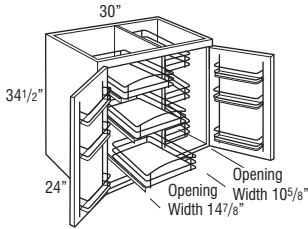

**BV2SC30RP**

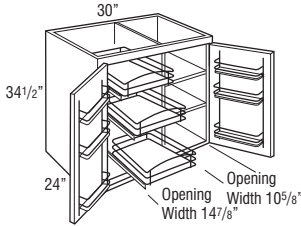

**BV2SC30RS**

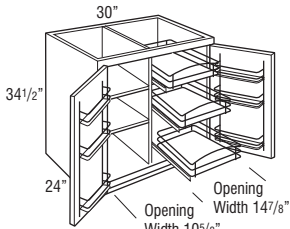

**BV2SC30SR**

Model	Cubic Feet
<b>BV2SC30PR</b>	17.7
<b>BV2SC30RP</b>	17.7
<b>BV2SC30RS</b>	17.7
<b>BV2SC30SR</b>	17.7

- Nomenclature represents left to right order of interior components.  
Example: BV2SC30RS = Base Version 2 SuperCabinet™ 30" Roll-out Shelves.
- Shelves are adjustable and 20" deep.
- Chrome Roll-out trays feature Smart Stop.
- Cabinets utilize 170° hinge. For sufficient pull-out clearance, 12" of adjacent space is required for door to open 170° when installed near a wall or corner.
- Each door features a chrome and wood three-tiered rack.
- Door rack width is 9 3/8".
- Door rack depth is 3 1/2".
- Side pull-outs feature 3 adjustable chrome and wood baskets on frame with Smart Stop.
- Integrated soft-close hinge not included. Premium door mechanism installed.

**Custom Modifications**

AUTHL AUTHR	CBO	CCO	CFNT0	CFP	CFRMO	CMAT	CND	DRT	DRWPWR	DRWSEC	DRWTK	EXBKL EXBKR
•	•	•	•		•						•	•
EXL EXR	FB	FD	FFDL FFDR	FPEB	FTK	FTKAV FTKFV	ID	INVFRM	LTI	MIP	P	PTOWB
•	•			•	•	•				•		
RD	RECTKALL RECTKBK	RECTKL RECTKR	RT	SCPDRW	TD	TOTSS TOTSSS	TVRAV TVRFV TVRVV	VTK	WLI			
	•	•						•	•			

**Construction Upgrades**

APC	ET	PE
•		•

**Door Options**

CG	DPSRR
	•

### 30" SUPERCABINET™ GOURMET

L O G I X

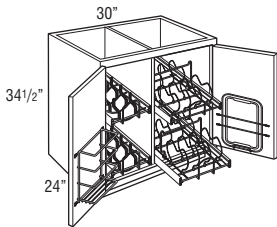

Model	Cubic Feet
<b>BSCG30 L or R</b>	17.7

- Cabinets utilize 170° hinge. For sufficient pull-out clearance, 12" of adjacent space is required for door to open 170° when installed near a wall or corner.
- Integrated soft-close hinge not included. Premium door mechanism included.
- L or R designates lid holder side.
- Left door features wrap/foil rack.
- Right door features cutting board and cutting board storage.
- Lid pull-out capacity is 6 lids per tray. Maximum lid diameter is 8 1/2" on bottom tray and 9 3/4" on top tray.
- Pots and Pans pull-out includes 8 dividers per tray for adjustable storage.
- Cutting board is 9 3/4" x 15 3/5".

**Custom Modifications**

AUTHL AUTHR	CBO	CCO	CFNT0	CFP	CFRMO	CMAT	CND	DRT	DRWPWR	DRWSEC	DRWTK	EXBKL EXBKR
•	•	•	•		•						•	•
EXL EXR	FB	FD	FFDL FFDR	FPEB	FTK	FTKAV FTKFV	ID	INVFRM	LTI	MIP	P	PTOWB
•	•			•	•	•				•		
RD	RECTKALL RECTKBK	RECTKL RECTKR	RT	SCPDRW	TD	TOTSS TOTSSS	TVRAV TVRFV TVRVV	VTK	WLI			
	•	•						•	•			

**Construction Upgrades**

APC	ET	PE
•		•

**Door Options**

CG	DPSRR
	•

36" SUPERCABINET™

L O G I X

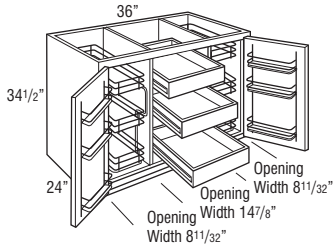

BSC36PRP

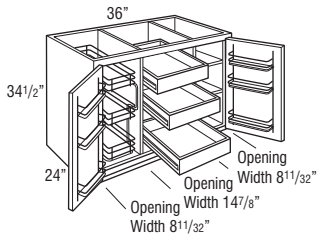

BSC36PRS

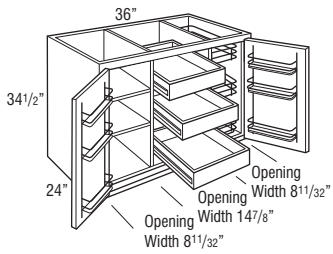

BSC36SRP

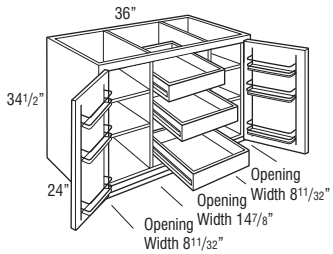

BSC36SRS

Model	Cubic Feet
BSC36PRP	21.1
BSC36PRS	21.1
BSC36SRP	21.1
BSC36SRS	21.1

- Nomenclature represents left to right order of interior components.  
Example: BSC36PRS = Base SuperCabinet™ 36" Pull-out Roll-out Shelves.
- Shelves are adjustable and 20" deep.
- Roll trays are Full Extension side-mounted.
- Cabinets utilize 170° hinge. For sufficient pull-out clearance, 12" of adjacent space is required for door to open 170° when installed near a wall or corner.
- Each door features a chrome and wood three-tiered rack.
- Door rack width is 12 3/8".
- Door rack depth is 3 1/2".
- Integrated soft-close hinge not included. Premium door mechanism installed.

Custom Modifications

AUTHL	AUTHR	CBO	CCO	CFNTD	CFP	CFRMO	CMAT	CND	DRT	DRWPWR	DRWSEC	DRWTK	EXBKL	EXBKR	
•	•	•	•	•	•	•	•	•	•	•	•	•	•	•	
EXL	EXR	FB	FD	FFDL	FFDR	FPEB	FTK	FTKAV	FTKFV	ID	INVFRM	LTI	MIP	P	PTOWB
•	•	•	•	•	•	•	•	•	•	•	•	•	•	•	•
RD	RECTKALL	RECTRKBK	RECTKL	RECTKR	RT	SCPDRW	TD	TOTSS	TOTSSS	TGRAV	TVRFV	TVRVV	VTK	WLI	
•	•	•	•	•	•	•	•	•	•	•	•	•	•	•	

Construction Upgrades

APC	ET	PE
•	•	•

Door Options

CG	DPSRR
•	•

### 36" SUPERCABINET™ VERSION 2

L O G I X

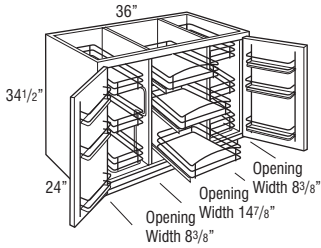

**BV2SC36PRP**

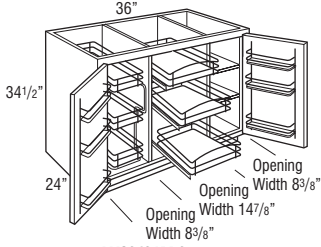

**BV2SC36PRS**

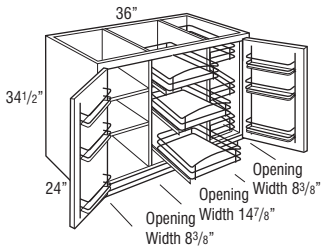

**BV2SC36SRP**

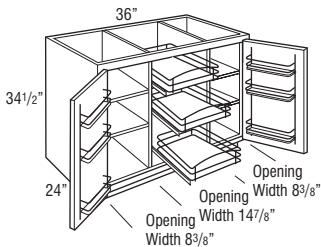

**BV2SC36SRS**

Model	Cubic Feet
<b>BV2SC36PRP</b>	21.1
<b>BV2SC36PRS</b>	21.1
<b>BV2SC36SRP</b>	21.1
<b>BV2SC36SRS</b>	21.1

- Nomenclature represents left to right order of interior components.  
Example: BV2SC36PRS = Base Version 2 SuperCabinet™ 36" Pull-out Roll-out Shelves.
- Shelves are adjustable and 20" deep.
- Chrome Roll-out trays feature Smart Stop.
- Cabinets utilize 170° hinge. For sufficient pull-out clearance, 12" of adjacent space is required for door to open 170° when installed near a wall or corner.
- Each door features a chrome and wood three-tiered rack.
- Door rack width is 13 7/8".
- Door rack depth is 3 1/2".
- Side pull-outs feature 3 adjustable chrome and wood baskets on frame with Smart Stop.
- Integrated soft-close hinge not included. Premium door mechanism installed.

**Custom Modifications**

AUTHL AUTHR	CBO	CCO	CFNT0	CFP	CFRMO	CMAT	CND	DRT	DRWPPWR	DRWSEC	DRWTK	EXBKL EXBKR
•	•	•	•		•						•	•
EXL EXR	FB	FD	FFDL FFDR	FPEB	FTK	FTKAV FTKRV	ID	INVFRM	ITI	MIP	P	PTOWB
•	•			•	•	•				•		
RD	RECTKALL RECTKBK	RECTKL RECTKR	RT	SCPORW	TD	TOTSS TOTSSS	TVRAV TVRFV TVRVV	VTK	WLI			
	•	•						•	•			

**Construction Upgrades**

APC	ET	PE
•		•

**Door Options**

CG	DPSRR
	•

### 36" SUPERCABINET™ GOURMET

L O G I X

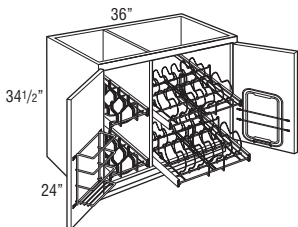

Model	Cubic Feet
<b>BSCG36 L or R</b>	21.1

- Cabinets utilize 170° hinge. For sufficient pull-out clearance, 12" of adjacent space is required for door to open 170° when installed near a wall or corner.
- Integrated soft-close hinge not included. Premium door mechanism included.
- L or R designates lid holder side.
- Left door features wrap/foil rack.
- Right door features cutting board and cutting board storage.
- Lid pull-out capacity is 6 lids per tray. Maximum lid diameter is 8 1/2" on bottom tray and 9 3/4" on top tray.
- Pots and Pans pull-out includes 8 dividers per tray for adjustable storage.
- Cutting board is 9 3/4" x 15 3/5".

**Custom Modifications**

AUTHL AUTHR	CBO	CCO	CFNT0	CFP	CFRMO	CMAT	CND	DRT	DRWPPWR	DRWSEC	DRWTK	EXBKL EXBKR
•	•	•	•		•						•	•
EXL EXR	FB	FD	FFDL FFDR	FPEB	FTK	FTKAV FTKRV	ID	INVFRM	ITI	MIP	P	PTOWB
•	•			•	•	•				•		
RD	RECTKALL RECTKBK	RECTKL RECTKR	RT	SCPORW	TD	TOTSS TOTSSS	TVRAV TVRFV TVRVV	VTK	WLI			
	•	•						•	•			

**Construction Upgrades**

APC	ET	PE
•		•

**Door Options**

CG	DPSRR
	•

**BASE with ROLL TRAYS**

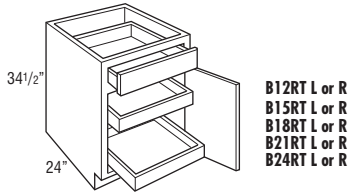

B12RT L or R  
B15RT L or R  
B18RT L or R  
B21RT L or R  
B24RT L or R

Model	Cubic Feet
B12RT L or R	7.7
B15RT L or R	9.4
B18RT L or R	11.1
B21RT L or R	12.8
B24RT L or R	14.4

- 2 roll trays standard.
- Cabinets may accommodate up to 4 roll trays, which may be purchased separately for field installation. See page 426.

**Custom Modifications**

AUTHL AUTHR	CBO	CCO	CFNTO	CFP	CFRMO	CMAT	CND	DRT	DRWPWR	DRWSEC	DRWTK	EXBKL EXBKR
•	•	•	•	•	•		•	•	•*	•*	•*	•
EXL EXR	FB	FD	FFDL FFDR	FPEB	FTK	FTKAV FTKFV	ID	INVFRM	LTI	MIP	P	PTOWB
•	•			•	•	•+				•		
RD	RECTKALL RECTKBK	RECTKL RECTKR	RT	SCPDRW	TD	TOTSS TOTSSS	TAVR TVRFV TVRVV	VTK	WLI			
•	•	•						•	•			

\*Not available on 12" and 15" wide \*Not available on 12" wide

**Construction Upgrades**

APC	ET	PE
•	•	•

**Door Options**

CG	DPSRR
•	•

**BASE DOUBLE DOOR with ROLL TRAYS**

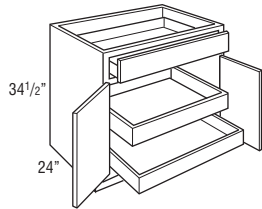

B24RT  
B27RT  
B30RT  
B33RT  
B36RT

B24RT	14.4
B27RT	16.1
B30RT	17.7
B33RT	19.6
B36RT	21.1

- 2 roll trays standard.
- Cabinet has butt doors, no center stile.
- Cabinet may accommodate up to 4 roll trays, which may be purchased separately for field installation. See page 426.

**Custom Modifications**

AUTHL AUTHR	CBO	CCO	CFNTO	CFP	CFRMO	CMAT	CND	DRT	DRWPWR	DRWSEC	DRWTK	EXBKL EXBKR
•	•	•	•	•	•		•	•	•	•*	•	•
EXL EXR	FB	FD	FFDL FFDR	FPEB	FTK	FTKAV FTKFV	ID	INVFRM	LTI	MIP	P	PTOWB
•	•			•	•	•				•		
RD	RECTKALL RECTKBK	RECTKL RECTKR	RT	SCPDRW	TD	TOTSS TOTSSS	TAVR TVRFV TVRVV	VTK	WLI			
•	•	•						•	•			

\*Available only on 24" wide

**Construction Upgrades**

APC	ET	PE
•	•	•

**Door Options**

CG	DPSRR
•	•

### BASE DOUBLE DOOR with ROLL TRAYS

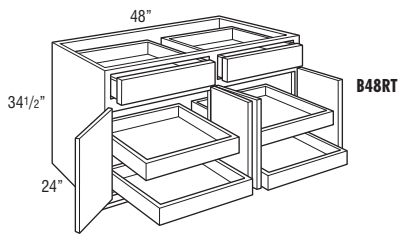
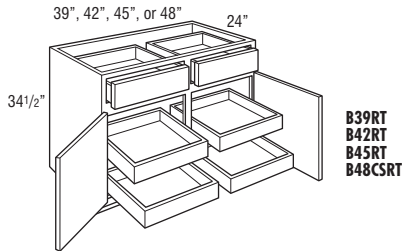

Model	Cubic Feet
B39RT	22.5
B42RT	24.2
B45RT	25.8
B48CSRT	27.5
B48RT	27.5

- 4 roll trays standard.
- Cabinet may accommodate up to 8 roll trays, which may be purchased separately for field installation. See page 426.

#### Custom Modifications

AUTHL AUTHR	CBO	CCO	CFNTO	CFP	CFRMO	CMAT	CND	DRT	DRWPWR	DRWSEC	DRWTK	EXBKL EXBKR
•	•	•	•	•	•		•	•	•	•*		•
EXL EXR	FB	FD	FFDL FFDR	FPEB	FTK	FTKAV FTKFV	ID	INVFRM	LTI	MIP	P	PTOWB
•	•			•	•	•				•		
RD	RECTKALL RECTKBK	RECTKL RECTKR	RT	SCPDRW	TD	TOTSS TOTSSS	TVRAV TVRFV TVRVV	VTK	WLI			
•	•	•			•			•	•			

\*Available only on 42" and 48" wide

#### Construction Upgrades

APC	ET	PE
•	•	•

#### Door Options

CG	DPSRR
•	•

### BASE FULL HEIGHT with ROLL TRAYS

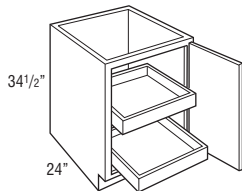

B12FHRT L or R	7.7
B15FHRT L or R	9.4
B18FHRT L or R	11.1
B21FHRT L or R	12.8
B24FHRT L or R	14.4

- 2 roll trays standard.
- Cabinets may accommodate up to 5 roll trays, which may be purchased separately for field installation. See page 426.

#### Custom Modifications

AUTHL AUTHR	CBO	CCO	CFNTO	CFP	CFRMO	CMAT	CND	DRT	DRWPWR	DRWSEC	DRWTK	EXBKL EXBKR
•	•	•	•		•			•			•*	•
EXL EXR	FB	FD	FFDL FFDR	FPEB	FTK	FTKAV FTKFV	ID	INVFRM	LTI	MIP	P	PTOWB
•	•			•	•	•				•		
RD	RECTKALL RECTKBK	RECTKL RECTKR	RT	SCPDRW	TD	TOTSS TOTSSS	TVRAV TVRFV TVRVV	VTK	WLI			
•	•	•						•	•			

\*Not available on 12" and 15" wide

#### Construction Upgrades

APC	ET	PE
•	•	•

#### Door Options

CG	DPSRR
•	•

**BASE FULL HEIGHT with ROLL TRAYS,  
40 1/2" HIGH**

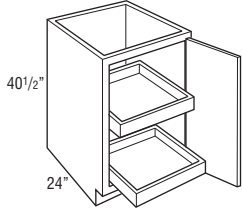

**B1540FHRT L or R  
B1840FHRT L or R  
B2140FHRT L or R  
B2440FHRT L or R**

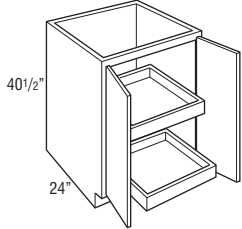

**B2440FHRT  
B2740FHRT**

Model	Cubic Feet
<b>B1540FHRT L or R</b>	10.5
<b>B1840FHRT L or R</b>	12.3
<b>B2140FHRT L or R</b>	14.2
<b>B2440FHRT L or R</b>	16.1
<b>B2440FHRT</b>	16.1
<b>B2740FHRT</b>	18.0

- 2 roll trays standard.
- Cabinets may accommodate up to 5 roll trays, which may be purchased separately for field installation. See page 426.

**Custom Modifications**

AUTHL AUTHR	CBO	CCO	CFNTD	CFP	CFRMO	CMAT	CND	DRT	DRWPWR	DRWSEC	DRWTK	EXBKL EXBKR
•	•	•	•	•	•	•	•	•	•	•	•*	•
EXL EXR	FB	FD	FFDL FFDR	FPEB	FTK	FTKAV FTKRV	ID	INVFRM	LTI	MIP	P	PTOWB
•	•	•	•	•	•	•	•	•	•	•	•	•
RD	RECTKALL RECTKBL	RECTKL RECTKR	RT	SCPDRW	TD	TOTSS TOTSSS	TVRAV TVRFV TVRVV	VTK	WLI			
•	•	•	•	•	•	•	•	•	•	•	•	•

\*Not available on 15" wide

**Construction Upgrades**

APC	ET	PE
•	•	•

**Door Options**

CG	DPSRR
•	•

**BASE FULL HEIGHT with ROLL TRAYS**

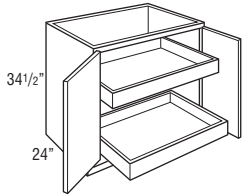

**B24FHRT  
B27FHRT  
B30FHRT  
B33FHRT  
B36FHRT**

<b>B24FHRT</b>	14.4
<b>B27FHRT</b>	16.1
<b>B30FHRT</b>	17.7
<b>B33FHRT</b>	19.6
<b>B36FHRT</b>	21.1

- 2 roll trays standard.
- Cabinet has full height butt doors, no center stile.
- Cabinet may accommodate up to 5 roll trays, which may be purchased separately. See page 426.

**Custom Modifications**

AUTHL AUTHR	CBO	CCO	CFNTD	CFP	CFRMO	CMAT	CND	DRT	DRWPWR	DRWSEC	DRWTK	EXBKL EXBKR
•	•	•	•	•	•	•	•	•	•	•	•	•
EXL EXR	FB	FD	FFDL FFDR	FPEB	FTK	FTKAV FTKRV	ID	INVFRM	LTI	MIP	P	PTOWB
•	•	•	•	•	•	•	•	•	•	•	•	•
RD	RECTKALL RECTKBL	RECTKL RECTKR	RT	SCPDRW	TD	TOTSS TOTSSS	TVRAV TVRFV TVRVV	VTK	WLI			
•	•	•	•	•	•	•	•	•	•	•	•	•

**Construction Upgrades**

APC	ET	PE
•	•	•

**Door Options**

CG	DPSRR
•	•



**BASE FULL HEIGHT DOUBLE DOOR with ROLL TRAYS**

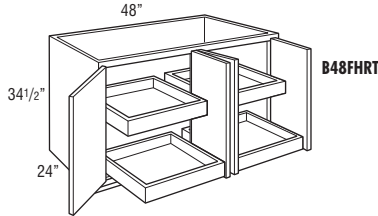
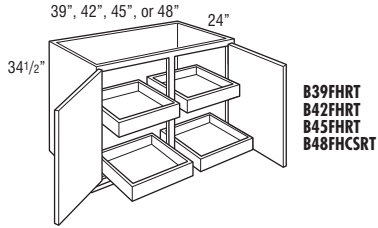

Model	Cubic Feet
<b>B39FHRT</b>	22.5
<b>B42FHRT</b>	24.2
<b>B45FHRT</b>	25.8
<b>B48FHCSRT</b>	27.5
<b>B48FHRT</b>	27.5

- 4 roll trays standard.
- Cabinet may accommodate up to 10 roll trays, which may be purchased separately. See page 426.

**Custom Modifications**

AUTHL AUTHR	CBO	CCO	CFNTO	CFP	CFRMO	CMAT	CND	DRT	DRWPWR	DRWSEC	DRWTK	EXBKL EXBKR
•	•	•	•		•			•				•
EXL EXR	FB	FD	FFDL FFDR	FPEB	FTK	FTKAV FTKRV	ID	INVFRM	LTI	MIP	P	PTOWB
•	•			•	•	•				•		
RD	RECTKALL RECTKBK	RECTKL RECTKR	RT	SCPDRW	TD	TOTSS TOTSSS	TVRAV TVRFV TVRVV	VTK	WLI			
•	•	•						•	•			

**Construction Upgrades**

APC	ET	PE
•	•	•

**Door Options**

CG	DPSRR
•	•

**BASE with CUTLERY INSERT WOOD ORGANIZER and ROLL TRAYS**

L G I X

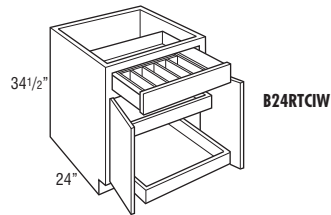
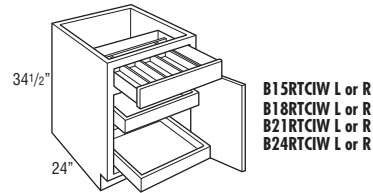

<b>B15RTCW L or R</b>	9.4
<b>B18RTCW L or R</b>	11.1
<b>B21RTCW L or R</b>	12.8
<b>B24RTCW L or R</b>	14.4
<b>B24RTCW</b>	14.4

- 2 roll trays standard.
- Cabinets may accommodate up to 4 roll trays, which may be purchased separately for field installation. See page 426.
- Cutlery Insert Wood Organizer is also available as an accessory. See page 418.

**Custom Modifications**

AUTHL AUTHR	CBO	CCO	CFNTO	CFP	CFRMO	CMAT	CND	DRT	DRWPWR	DRWSEC	DRWTK	EXBKL EXBKR
•	•	•	•	•	•		•	•			•*	•
EXL EXR	FB	FD	FFDL FFDR	FPEB	FTK	FTKAV FTKRV	ID	INVFRM	LTI	MIP	P	PTOWB
•	•			•	•	•				•		
RD	RECTKALL RECTKBK	RECTKL RECTKR	RT	SCPDRW	TD	TOTSS TOTSSS	TVRAV TVRFV TVRVV	VTK	WLI			
•	•	•						•	•			

\*Not available on 15" wide

**Construction Upgrades**

APC	ET	PE
•	•	•

**Door Options**

CG	DPSRR
•	•

**BASE with WOOD TIERED CUTLERY DIVIDER DRAWER and ROLL TRAYS**

LOGIX

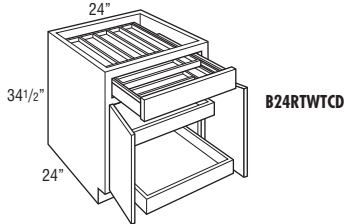
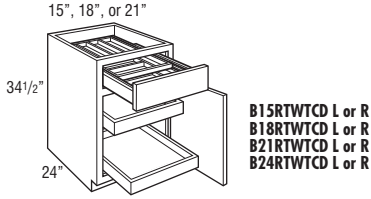

Model	Cubic Feet
B15RTWCD L or R	9.4
B18RTWCD L or R	11.1
B21RTWCD L or R	12.8
B24RTWCD L or R	14.4
<b>B24RTWCD</b>	<b>14.4</b>

- 2 roll trays standard.
- Cabinets may accommodate up to 4 roll trays, which may be purchased separately for field installation. See page 426.
- Exterior WTCD drawer box height is 3 3/4", interior height of top and bottom tier is 1 3/8".
- Wood Tiered Cutlery Divider Drawer is also available as an accessory. See page 418.

**Custom Modifications**

AUTHL AUTHR	CBO	CCO	CFNTD	CFP	CFRMO	CMAT	CND	DRT	DRWPWR	DRWSEC	DRWTK	EXBKL EXBKR
•	•	•	•	•	•	•	•	•			•*	•
EXL EXR	FB	FD	FFDL FFDR	FPEB	FTK	FTKAV FTKFV	ID	INVFRM	LTI	MIP	P	PTOWB
•	•			•	•	•				•		
RD	RECTKALL RECTKBK	RECTKL RECTKR	RT	SCPDRW	TD	TOTSS TOTSSS	TVRAV TVRFV TVRVV	VTK	WLI			
	•	•						•	•			

\*Not available on 15" wide

**Construction Upgrades**

APC	ET	PE
•	•	•

**Door Options**

CG	DPSRR
•	•

**BASE with WOOD TIERED K-CUP\* DRAWER and ROLL TRAYS**

LOGIX

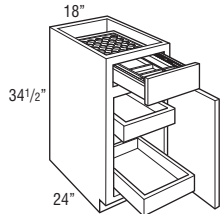

Model	Cubic Feet
B18KUPRT L or R	11.1

- 2 roll trays standard.
- Cabinets may accommodate up to 4 roll trays, which may be purchased separately for field installation. See page 426.
- Exterior Wood Tiered K-Cup drawer box height is 3 3/4", interior height of top tier is 1 5/8", and interior height of bottom tier is 1 3/8".
- The Wood Tiered K-Cup Drawer is compatible with K-Cup pods only.
- Wood Tiered K-Cup Drawer is also available as an accessory. See page 419.

\*K-Cup is a registered trademark of Keurig Green Mountain, Inc.

**Custom Modifications**

AUTHL AUTHR	CBO	CCO	CFNTD	CFP	CFRMO	CMAT	CND	DRT	DRWPWR	DRWSEC	DRWTK	EXBKL EXBKR
•	•	•	•	•	•	•	•	•			•	•
EXL EXR	FB	FD	FFDL FFDR	FPEB	FTK	FTKAV FTKFV	ID	INVFRM	LTI	MIP	P	PTOWB
•	•			•	•	•				•		
RD	RECTKALL RECTKBK	RECTKL RECTKR	RT	SCPDRW	TD	TOTSS TOTSSS	TVRAV TVRFV TVRVV	VTK	WLI			
	•	•						•	•			

**Construction Upgrades**

APC	ET	PE
•	•	•

**Door Options**

CG	DPSRR
•	•

**BASE with DRAWER and LID ORGANIZER and ROLL TRAYS**

LOGIX

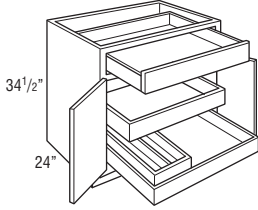

Model	Cubic Feet
<b>B30RTLO</b>	17.7
<b>B33RTLO</b>	19.6
<b>B36RTLO</b>	21.1

- 2 roll trays standard.
- Cabinet has butt doors, no center stile.
- Pots and Pans Lid Organizer is also available as an accessory for field installation. See page 421.
- The lid organizer is attached to the roll tray with 2 screws for shipping purposes only. Screws should be removed during installation to make the lid organizer mobile.

**Custom Modifications**

AUTHL AUTHR	CBO	CCO	CFNT0	CFP	CFRMO	CMAT	CND	DRT	DRWPWR	DRWSEC	DRWTK	EXBKL EXBKR
•	•	•	•	•	•		•		•		•	•
EXL EXR	FB	FD	FFDL FFDR	FPEB	FTK	FTKAV FTKFV	ID	INVFRM	LTI	MIP	P	PTOWB
•	•			•	•	•				•		
RD	RECTKALL RECTKBK	RECTKL RECTKR	RT	SCPDRW	TD	TOTSS TOTSSS	TVRAV TVRFV TVRVV	VTK	WLI			
	•	•		•				•	•			

**Construction Upgrades**

APC	ET	PE
•	•	•

**Door Options**

CG	DPSRR
•	•

**BASE with LID ORGANIZER and ROLL TRAYS**

LOGIX

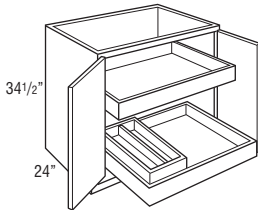

<b>B30FHRTLO</b>	17.7
<b>B33FHRTLO</b>	19.6
<b>B36FHRTLO</b>	21.1

- 2 roll trays standard.
- Cabinet has full height butt doors, no center stile.
- Cabinet may accommodate up to 5 roll trays, which may be purchased separately for field installation. See page 426.
- Pots and Pans Lid Organizer is also available as an accessory for field installation. See page 421.
- The lid organizer is attached to the roll tray with 2 screws for shipping purposes only. Screws should be removed during installation to make the lid organizer mobile.

**Custom Modifications**

AUTHL AUTHR	CBO	CCO	CFNT0	CFP	CFRMO	CMAT	CND	DRT	DRWPWR	DRWSEC	DRWTK	EXBKL EXBKR
•	•	•	•	•	•						•	•
EXL EXR	FB	FD	FFDL FFDR	FPEB	FTK	FTKAV FTKFV	ID	INVFRM	LTI	MIP	P	PTOWB
•	•			•	•	•				•		
RD	RECTKALL RECTKBK	RECTKL RECTKR	RT	SCPDRW	TD	TOTSS TOTSSS	TVRAV TVRFV TVRVV	VTK	WLI			
	•	•						•	•			

**Construction Upgrades**

APC	ET	PE
•	•	•

**Door Options**

CG	DPSRR
•	•

**POTS & PANS ORGANIZER BASE with DRAWER**

LOGIX

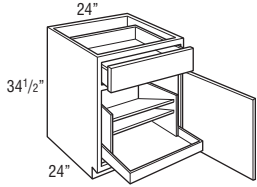

**B24PS L or R**

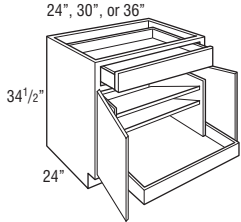

**B24PS  
B30PS  
B36PS**

Model	Cubic Feet
<b>B24PS L or R</b>	14.4
<b>B24PS</b>	14.4
<b>B30PS</b>	17.7
<b>B36PS</b>	21.1

- Cabinet has butt doors, no center stile.
- Cabinet has bottom roll tray with double lid storage shelves above.
- Base Pan Storage unit is also available as an accessory for field installation. See page 417.

**Custom Modifications**

AUTHL AUTHR	CBO	CCO	CFNTO	CFP	CFRMO	CMAT	CND	DRT	DRWPWR	DRWSEC	DRWTK	EXBKL EXBKR
•	•	•	•	•	•	•	•	•	•	•*	•	•
EXL EXR	FB	FD	FFDL FFDR	FPEB	FTK	FTKAV FTKFV	ID	INVFRM	LTI	MIP	P	PTOWB
•	•	•	•	•	•	•	•	•	•	•	•	•
RD	RECTKALL RECTKBK	RECTKL RECTKR	RT	SCPDRW	TD	TOTSS TOTSSS	TVRAV TVRFV TVRVV	VTK	WLI			
•	•	•	•	•	•	•	•	•	•	•	•	•

\*Available only on 24" wide

**Construction Upgrades**

APC	ET	PE
•	•	•

**Door Options**

CG	DPSRR
•	•

**BASE POTS & PANS PULL-OUT**

LOGIX

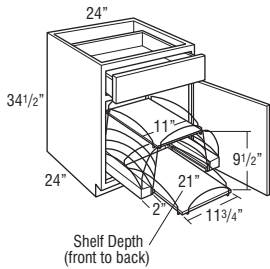

**BPPP24 L or R**

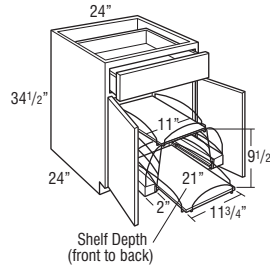

**BPPP24**

Model	Cubic Feet
<b>BPPP24 L or R</b>	14.4
<b>BPPP24</b>	14.4

- Full Extension slide-out shelves pull out independently.
- Pots and Pans Pull-out is also available as an accessory for field installation. See page 422.
- For full access from both sides of unit, do not install against a wall or next to deeper appliances and cabinets.

**Custom Modifications**

AUTHL AUTHR	CBO	CCO	CFNTO	CFP	CFRMO	CMAT	CND	DRT	DRWPWR	DRWSEC	DRWTK	EXBKL EXBKR
•	•	•	•	•	•	•	•	•	•	•	•	•
EXL EXR	FB	FD	FFDL FFDR	FPEB	FTK	FTKAV FTKFV	ID	INVFRM	LTI	MIP	P	PTOWB
•	•	•	•	•	•	•	•	•	•	•	•	•
RD	RECTKALL RECTKBK	RECTKL RECTKR	RT	SCPDRW	TD	TOTSS TOTSSS	TVRAV TVRFV TVRVV	VTK	WLI			
•	•	•	•	•	•	•	•	•	•	•	•	•

**Construction Upgrades**

APC	ET	PE
•	•	•

**Door Options**

CG	DPSRR
•	•

**BASE POTS & PANS PULL-OUT**

L O G I X

Model	Cubic Feet
<b>BPPP30</b>	17.7

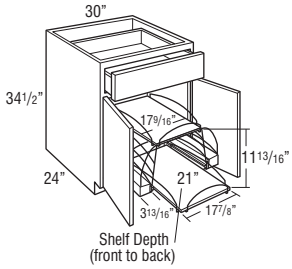

- Full Extension slide-out shelves pull out independently.
- Pots and Pans Pull-out is also available as an accessory for field installation. See page 422.
- For full access from both sides of unit, do not install against a wall or next to deeper appliances and cabinets.

**Custom Modifications**

AUTHL AUTHR	CBO	CCO	CFNT0	CFP	CFRMO	CMAT	CND	DRT	DRWPWR	DRWSEC	DRWTK	EXBKL EXBKR
•	•	•	•	•	•		•		•		•	•
EXL EXR	FB	FD	FFDL FFDR	FPEB	FTK	FTKAV FTKFV	ID	INVFRM	LTI	MIP	P	PTOWB
•	•			•	•	•				•		
RD	RECTKALL RECTKBK	RECTKL RECTKR	RT	SCPDRW	TD	TOTSS TOTSSS	TVRAV TVRFV TVRVV	VTK	WLI			
	•	•		•				•	•			

**Construction Upgrades**

APC	ET	PE
•		•

**Door Options**

CG	DPSRR
•	•

**BASE with FOOD STORAGE CONTAINER ORGANIZER**

L O G I X

<b>B18FSCO L or R</b>	11.1
<b>B24FSCO L or R</b>	14.4

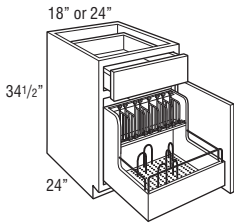

- Pull-out features natural finished hardwood dovetailed box with chrome rails on lower section with undermount Smart Stop guides.
- Includes seven chrome "U" pegs to use on the pegboard bottom to customize the fit to container sizes.
- Adjustable clip-on lid dividers included to fit with a variety of lid shapes. 18" wide includes five dividers, 24" wide includes eight dividers.
- Front of pull-out is routed for easy access.

**Custom Modifications**

AUTHL AUTHR	CBO	CCO	CFNT0	CFP	CFRMO	CMAT	CND	DRT	DRWPWR	DRWSEC	DRWTK	EXBKL EXBKR
•	•	•	•	•	•		•		•		•	•
EXL EXR	FB	FD	FFDL FFDR	FPEB	FTK	FTKAV FTKFV	ID	INVFRM	LTI	MIP	P	PTOWB
•	•			•	•	•				•		
RD	RECTKALL RECTKBK	RECTKL RECTKR	RT	SCPDRW	TD	TOTSS TOTSSS	TVRAV TVRFV TVRVV	VTK	WLI			
	•	•		•				•	•			

**Construction Upgrades**

APC	ET	PE
•		•

**Door Options**

CG	DPSRR
•	•

**BASE with CAN and WINE BOTTLE PULL-OUTS**

L O G I X

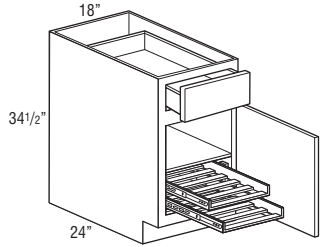

**B18CWP12 L or R**

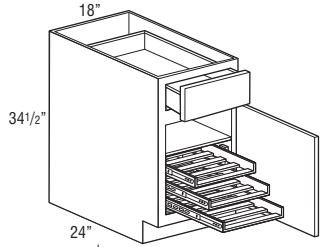
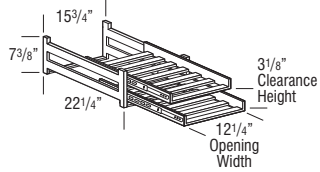

**B18CWP18 L or R**

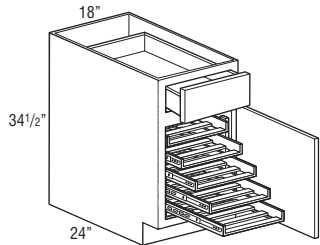
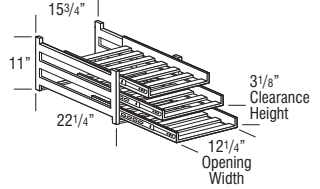

**B18CWP30 L or R**

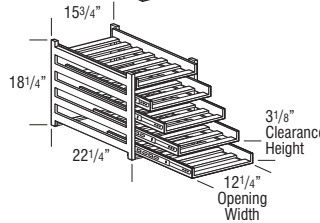

Model	Cubic Feet
<b>B18CWP12 L or R</b>	11.1
<b>B18CWP18 L or R</b>	11.1
<b>B18CWP30 L or R</b>	11.1

- Pull-outs feature natural finished hardwood with side-mounted guides (Smart Stop not included).
- One adjustable full depth shelf on B18CWP12 and B18CWP18.
- B18CWP12 holds twelve wine bottles.  
B18CWP18 holds eighteen wine bottles.  
B18CWP30 holds thirty wine bottles.

**Custom Modifications**

AUTHL AUTHR	CBO	CCO	CFNTD	CFP	CFRMO	CMAT	CND	DRT	DRWPWR	DRWSEC	DRWTK	EXBKL EXBKR
•	•	•	•	•	•		•		•	•	•	•
EXL EXR	FB	FD	FFDL FFDR	FPEB	FTK	FTKAV FTKFV	ID	INVFRM	LTI	MIP	P	PTOWB
•	•	STD	•	•	•	•		•		•		
RD	RECTKALL RECTKBK	RECTKL RECTKR	RT	SCPDRW	TD	TOTSS TOTSSS	TVRAV TVRFV TVRVV	VTK	WLI			
	•	•		•				•	•			

**Construction Upgrades**

APC	ET	PE
•		•

**Door Options**

CG	DPSRR
•	•

**BASE FULL HEIGHT with CAN and WINE BOTTLE PULL-OUTS**

L G I X

Model	Cubic Feet
B18FHCWP12 L or R	11.1
B18FHCWP18 L or R	11.1
B18FHCWP30 L or R	11.1

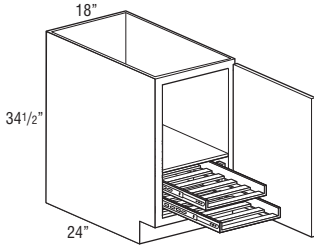

**B18FHCWP12 L or R**

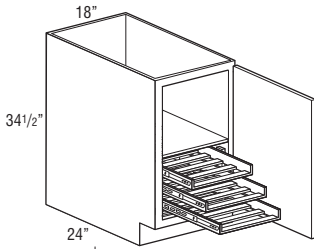
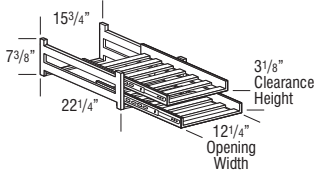

**B18FHCWP18 L or R**

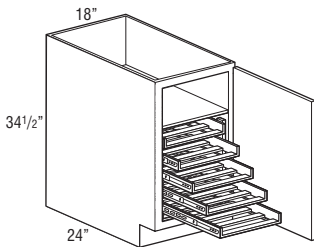
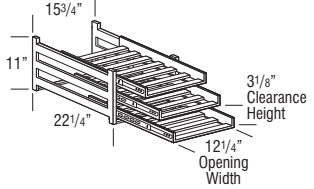

**B18FHCWP30 L or R**

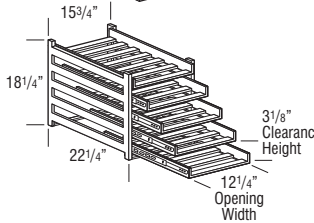

- Pull-outs feature natural finished hardwood with side-mounted guides (Smart Stop not included).
- One adjustable full depth shelf.
- B18FHCWP12 holds twelve wine bottles.  
B18FHCWP18 holds eighteen wine bottles.  
B18FHCWP30 holds thirty wine bottles.

**Custom Modifications**

AUTHL	CBO	CCO	CFNTD	CFP	CFRMO	CMAT	CND	DRT	DRWPWR	DRWSEC	DRWTK	EXBKL	
AUTHR												EXBKR	
•	•	•	•	•	•		•				•	•	
EXL	FB	FD	FFDL	FPEB	FTK	FTKAV	ID	INVFRM	LTI	MIP	P	PTOWB	
EXR													
•	•	STD	•	•	•	•				•			
RD	RECTKALL	RECTKLBK	RECTKLR	RT	SCDRW	TD	TOTSS	TOTSSS	TVRAV	TVRFV	TVRVV	VTK	WLI
	•	•								•		•	

**Construction Upgrades**

APC	ET	PE
•		•

**Door Options**

CG	DPSRR
•	•

**BASE with ROLL-OUT TRAY DIVIDER** L O G I X

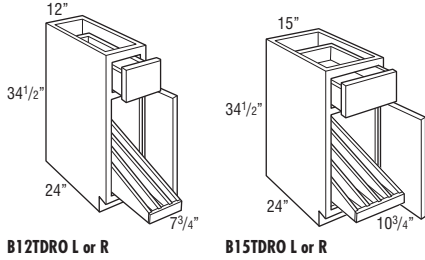

**B12TDRO L or R**

**B15TDRO L or R**

Model	Cubic Feet
<b>B12TDRO L or R</b>	<b>7.8</b>
<b>B15TDRO L or R</b>	<b>9.4</b>

- Dividers are removable.
- 12" - 3 compartments.
- 15" - 4 compartments.
- Roll-out Tray Divider is also available as an accessory for field installation. See page 424.
- Tray divider utilizes Smart Stop undermount guides and bumpers for door protection.

**Custom Modifications**

AUTHL AUTHR	CBO	CCO	CFNT0	CFP	CFRMO	CMAT	CND	DRT	DRWPWR	DRWSEC	DRWTK	EXBKL EXBKR
•	•	•	•	•	•		•					•
EXL EXR	FB	FD	FFDL FFDR	FPEB	FTK	FTKAV FTKFV	ID	INVFRM	LTI	MIP	P	PTOWB
•	•			•	•	•*				•		
RD	RECTKALL RECTKBK	RECTKL RECTKR	RT	SCPDRW	TD	TOTSS TOTSSS	TVRAV TVRFV TVRVV	VTK	WLI			
	•	•		•				•	•			

\*Not available on 12" wide

**Construction Upgrades**

APC	ET	PE
•		•

**Door Options**

CG	DPSRR
•	•

**BASE with TRAY DIVIDER**

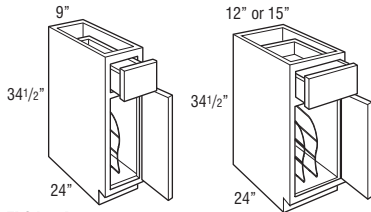

**TD9 L or R**

**TD12 L or R  
TD15 L or R**

<b>TD9 L or R</b>	<b>6.1</b>
<b>TD12 L or R</b>	<b>7.8</b>
<b>TD15 L or R</b>	<b>9.4</b>

- Tray Divider is chrome.
- Tray Divider is also available as an accessory for field installation. See page 424.

**Custom Modifications**

AUTHL AUTHR	CBO	CCO	CFNT0	CFP	CFRMO	CMAT	CND	DRT	DRWPWR	DRWSEC	DRWTK	EXBKL EXBKR
•	•	•	•	•	•		•					•
EXL EXR	FB	FD	FFDL FFDR	FPEB	FTK	FTKAV FTKFV	ID	INVFRM	LTI	MIP	P	PTOWB
•	•			•	•	•*				•*	•	
RD	RECTKALL RECTKBK	RECTKL RECTKR	RT	SCPDRW	TD	TOTSS TOTSSS	TVRAV TVRFV TVRVV	VTK	WLI			
	•†	•		•				•	•			

\*Not available on 9" and 12" wide \*Not available on 9" wide

**Construction Upgrades**

APC	ET	PE
•		•

**Door Options**

CG	DPSRR
•†	•

†Not available on 9" wide



### BASE FULL HEIGHT with TRAY DIVIDER

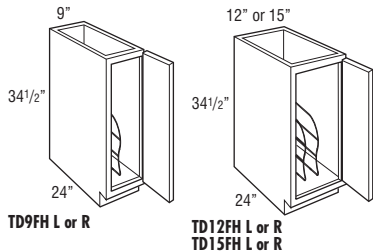

Model	Cubic Feet
TD9FH L or R	6.1
TD12FH L or R	7.8
TD15FH L or R	9.4

- Tray Divider is chrome.
- Tray Divider is also available as an accessory for field installation. See page 424.

#### Custom Modifications

AUTHL AUTHR	CBO	CCO	CFNTO	CFP	CFRMO	CMAT	CND	DRT	DRWPWR	DRWSEC	DRWTK	EXBKL EXBKR
•	•	•	•		•							•
EXL EXR	FB	FD	FFDL FFDR	FPEB	FTK	FTKAV FTKFV	ID	INVFRM	LTI	MIP	P	PTOWB
•	•			•	•	•*			•*	•		
RD	RECTKALL RECTKBK	RECTKL RECTKR	RT	SCPDRW	TD	TOTSS TOTSSS	TVRAV TVRFV TVRVV	VTK	WLI			
	•+	•						•	•			

\*Not available on 9" and 12" wide    \*Not available on 9" wide

#### Construction Upgrades

APC	ET	PE
•		•

#### Door Options

CG	DPSRR
•†	•

†Not available on 9" wide

### BASE CABINET with MIXER SHELF

LOGIX

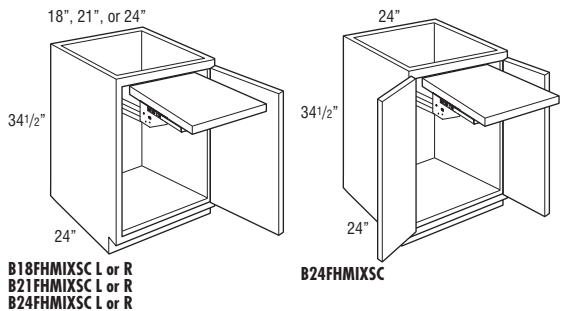

B18FHMIXSC L or R	11.1
B21FHMIXSC L or R	12.8
B24FHMIXSC L or R	14.4
B24FHMIXSC	14.4

- Includes mixer lift with Smart Stop closing feature.
- Mixer shelf will be 3/4" thick natural finished veneer plywood, mixer shelf dimensions:  
18" wide: 11 3/4" wide x 20" deep.  
21" wide: 14 3/4" wide x 20" deep.  
24" wide: 17 3/4" wide x 20" deep.
- Maximum Weight Capacity for Mixer Shelf: 60 lbs.
- Mixer shelf locks in the fully open position. Release brackets lower the mixer shelf back into the cabinet.
- When in closed position, clearance above shelf is 17 5/8"; clearance below shelf is 7 3/4".

#### Custom Modifications

AUTHL AUTHR	CBO	CCO	CFNTO	CFP	CFRMO	CMAT	CND	DRT	DRWPWR	DRWSEC	DRWTK	EXBKL EXBKR
•	•	•	•		•							•
EXL EXR	FB	FD	FFDL FFDR	FPEB	FTK	FTKAV FTKFV	ID	INVFRM	LTI	MIP	P	PTOWB
•	•			•	•	•				•		
RD	RECTKALL RECTKBK	RECTKL RECTKR	RT	SCPDRW	TD	TOTSS TOTSSS	TVRAV TVRFV TVRVV	VTK	WLI			
	•	•						•	•			

#### Construction Upgrades

APC	ET	PE
•		•

#### Door Options

CG	DPSRR
•	•

**SINK BASE**

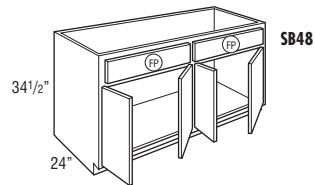
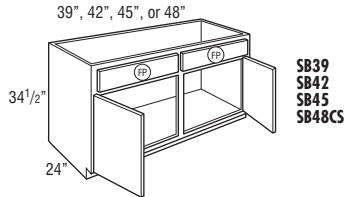
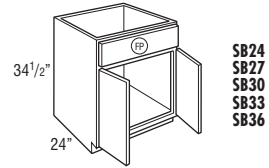
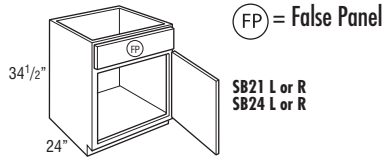

Model	Cubic Feet
<b>SB21 L or R</b>	12.8
<b>SB24 L or R</b>	14.4
<b>SB24</b>	14.4
<b>SB27</b>	16.1
<b>SB30</b>	17.7
<b>SB33</b>	19.6
<b>SB36</b>	21.1
<b>SB39</b>	22.7
<b>SB42</b>	24.4
<b>SB45</b>	25.8
<b>SB48CS</b>	27.7
<b>SB48</b>	27.7

• Mini Touch-up Kit (MTUK) included. MTUK includes small touch-up marker and small fill stick.

**Custom Modifications**

AUTHL AUTHR	CBO	CCO	CFNTD	CFP	CFRMO	CMAT	CND	DRT	DRWPWR	DRWSEC	DRWTK	EXBKL EXBKR
•		•	•	STD	•	•*	•				•+	•
EXL EXR	FB	FD	FFDL FFDR	FPEB	FTK	FTKAV FTKFV	ID	INVFRM	LTI	MIP	P	PTOWB
•	•		•	•	•	•	•		•	•	•	
RD	RECTKALL RECTKBK	RECTKL RECTKR	RT	SCPDRW	TD	TOTSS TOTSSS	TVRAV TVRFV TVRVV	VTK	WLI			
•	•	•	•			•		•	•			

\*Available only on 30", 33", and 36" wide \*Not available on 39", 42", 45", and 48" wide

**Construction Upgrades**

APC	ET	PE
•		•

**Door Options**

CG	DPSRR
•	•

**SINK BASE with CABMAT™**

L O G I X

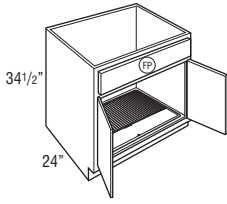

Model	Cubic Feet
SB30CM	17.7
SB33CM	19.6
SB36CM	21.1

- Mini Touch-up Kit (MTUK) included. MTUK includes small touch-up marker and small fill stick.
- CabMat™ features a gray sloped mat to capture spills.
- CabMat™ is removable for cleaning.

Model	Liquid Capacity		Cabinet Size	
	Quarts	Liters	Width	Depth
SB30CM	4.2	3.9	30"	24"
SB33CM	4.6	4.3	33"	24"
SB36CM	5.0	4.7	36"	24"

**Custom Modifications**

AUTHL AUTHR	CBO	CCO	CFNTO	CFP	CFRMO	CMAT	CND	DRT	DRWPWR	DRWSEC	DRWTK	EXBKL EXBKR
•	•	•	•	STD	•		•				•	•
EXL EXR	FB	FD	FFDL FFDR	FPEB	FTK	FTKAV FTKRV	ID	INVFRM	LTI	MIP	P	PTOWB
•	•		•	•	•	•	•		•	•	•	
RD	RECTKALL RECTKBK	RECTKL RECTKR	RT	SCDRW	TD	TOTSS TOTSSS	TVRAV TVRFV TVRVV	VTK	WLI			
	•	•				•		•	•			

**Construction Upgrades**

APC	ET	PE
•		•

**Door Options**

CG	DPSRR
	•

**SINK BASE with CADDY**

L O G I X

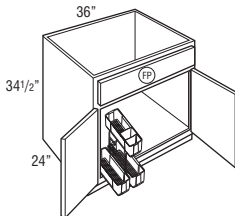

Model	Cubic Feet
SB36CDY L or R	20.9

- Mini Touch-up Kit (MTUK) included. MTUK includes small touch-up marker and small fill stick.
- L or R designates caddy location.
- Caddy is removable and portable.
- Caddy dimensions are: 9 15/16" wide x 18 5/16" tall x 18 5/8" deep.

**Custom Modifications**

AUTHL AUTHR	CBO	CCO	CFNTO	CFP	CFRMO	CMAT	CND	DRT	DRWPWR	DRWSEC	DRWTK	EXBKL EXBKR
•	•	•	•		•		•					•
EXL EXR	FB	FD	FFDL FFDR	FPEB	FTK	FTKAV FTKRV	ID	INVFRM	LTI	MIP	P	PTOWB
•	•		•	•	•	•	•		•			
RD	RECTKALL RECTKBK	RECTKL RECTKR	RT	SCDRW	TD	TOTSS TOTSSS	TVRAV TVRFV TVRVV	VTK	WLI			
	•	•				•		•	•			

**Construction Upgrades**

APC	ET	PE
•		•

**Door Options**

CG	DPSRR
•	•

**SINK BASE, 27" DEEP, SINGLE or DOUBLE DOOR**

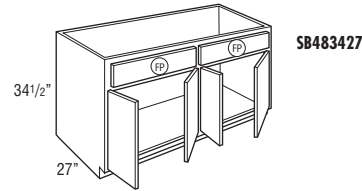
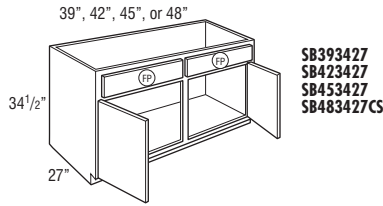
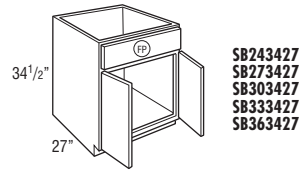
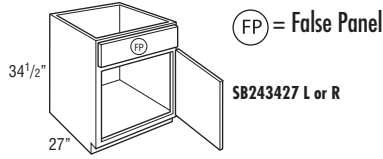

Model	Cubic Feet
SB243427 L or R	16.2
SB243427	16.2
SB273427	18.1
SB303427	19.9
SB333427	22.1
SB363427	23.7
SB393427	25.5
SB423427	27.5
SB453427	25.8
SB483427CS	31.2
SB483427	31.2

• Mini Touch-up Kit (MTUK) included. MTUK includes small touch-up marker and small fill stick.

**Custom Modifications**

AUTHL AUTHR	CBO	CCO	CFNTO	CFP	CFRMO	CMAT	CND	DRT	DRWPWR	DRWSEC	DRWTK	EXBKL EXBKR
•		•	•	STD	•		•					•
EXL EXR	FB	FD	FFDL FFDR	FPEB	FTK	FTKAV FTKRV	ID	INVFRM	LTI	MIP	P	PTOWB
•	•			•	•	•			•	•	•	
RD	RECTKALL RECTKBL	RECTKL RECTKR	RT	SCPDRW	TD	TOTSS TOTSSS	TVRAV TVRFV TVRVV	VTK	WLI			
	•	•				•		•	•			

**Construction Upgrades**

APC	ET	PE
•		•

**Door Options**

CG	DPSRR
•	•

**SINK BASE with TILT-OUT TRAYS**

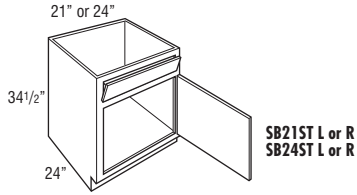

SB21ST L or R  
SB24ST L or R

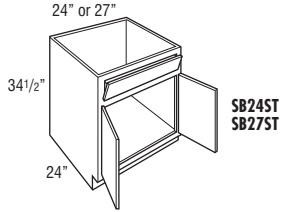

SB24ST  
SB27ST

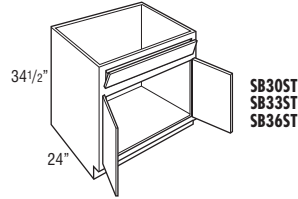

SB30ST  
SB33ST  
SB36ST

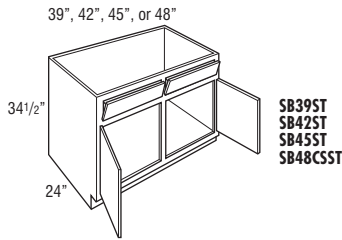

SB39ST  
SB42ST  
SB45ST  
SB48CSST

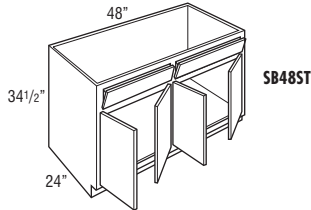

SB48ST

Model	Cubic Feet
SB21ST L or R	12.8
SB24ST L or R	14.4
SB24ST	14.4
SB27ST	16.1
SB30ST	17.7
SB33ST	19.6
SB36ST	21.1
SB39ST	22.7
SB42ST	24.4
SB45ST	25.7
SB48CSST	27.7
SB48ST	27.7

- Tilt-out trays are stain resistant, moisture resistant plastic to allow storage of sponges and other cleaning materials.
- Mini Touch-up Kit (MTUK) included. MTUK includes small touch-up marker and small fill stick.
- Includes two tilt-out trays on 30"-48" wide.
- Tilt-out trays are also available as an accessory for field installation. See page 423.

**Custom Modifications**

AUTHL AUTHR	CBO	CCO	CFNT0	CFP	CFRMO	CMAT	CND	DRT	DRWPWR	DRWSEC	DRWTK	EXBKL EXBKR
•		•	•		•	•*	•				•*	•
EXL EXR	FB	FD	FFDL FFDR	FPEB	FTK	FTKAV FTKFV	ID	INVFRM	LTI	MIP	P	PTOWB
•	•		•	•	•	•	•		•	•	•	
RD	RECTKALL RECTKBK	RECTKL RECTKR	RT	SCPDRW	TD	TOTSS TOTSSS	TVRAV TVRFV TVRVV	VTK	WLI			
•	•	•	•				•	•	•			

\*Available only on 30", 33", and 36" wide    \*Not available on 39", 42", 45", and 48" wide

**Construction Upgrades**

APC	ET	PE
•		•

**Door Options**

CG	DPSRR
•	•

**SINK BASE with TILT-OUT TRAYS and CABMAT™**

L O G I X

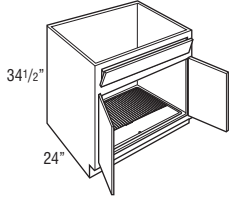

Model	Cubic Feet
<b>SB30STCM</b>	17.7
<b>SB33STCM</b>	19.6
<b>SB36STCM</b>	21.1

- Mini Touch-up Kit (MTUK) included. MTUK includes small touch-up marker and small fill stick.
- CabMat™ features a gray sloped mat to capture spills.
- CabMat™ is removable for cleaning.
- Tilt-out trays are stain resistant, moisture resistant plastic to allow storage of sponges and other cleaning materials.
- Includes two tilt-out trays.
- Tilt-out trays are also available as an accessory for field installation. See page 423.

Model	Liquid Capacity		Cabinet Size	
	Quarts	Liters	Width	Depth
SB30STCM	4.2	3.9	30"	24"
SB33STCM	4.6	4.3	33"	24"
SB36STCM	5.0	4.7	36"	24"

**Custom Modifications**

AUTHL AUTHR	CBO	CCO	CFNTO	CFP	CFRMO	CMAT	CND	DRT	DRWPWR	DRWSEC	DRWTK	EXBKL EXBKR
•	•	•	•		•		•				•	•
EXL EXR	FB	FD	FFDL FFDR	FPEB	FTK	FTKAV FTKFV	ID	INVFRM	LTI	MIP	P	PTOWB
•	•		•	•	•	•			•	•	•	
RD	RECTKALL RECTKBK	RECTKL RECTKR	RT	SCPDRW	TD	TOTSS TOTSSS	TVRAV TVRFV TVRVV	VTK	WLI			
	•	•						•	•			

**Construction Upgrades**

APC	ET	PE
•		•

**Door Options**

CG	DPSRR
	•

**SINK BASE with TILT-OUT TRAYS and CADDY**

L O G I X

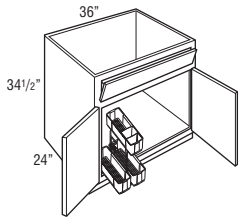

<b>SB36STCDY L or R</b>	20.9
-------------------------	------

- Mini Touch-up Kit (MTUK) included. MTUK includes small touch-up marker and small fill stick.
- L or R designates caddy location.
- Caddy is removable and portable.
- Tilt-out trays are stain resistant, moisture resistant plastic to allow storage of sponges and other cleaning materials.
- Includes two tilt-out trays.
- Tilt-out trays are also available as an accessory for field installation. See page 423.
- Caddy dimensions are: 9 15/16" wide x 18 5/16" tall x 18 5/8" deep.

**Custom Modifications**

AUTHL AUTHR	CBO	CCO	CFNTO	CFP	CFRMO	CMAT	CND	DRT	DRWPWR	DRWSEC	DRWTK	EXBKL EXBKR
•	•	•	•		•		•				•	•
EXL EXR	FB	FD	FFDL FFDR	FPEB	FTK	FTKAV FTKFV	ID	INVFRM	LTI	MIP	P	PTOWB
•	•		•	•	•	•	•		•	•	•	
RD	RECTKALL RECTKBK	RECTKL RECTKR	RT	SCPDRW	TD	TOTSS TOTSSS	TVRAV TVRFV TVRVV	VTK	WLI			
	•	•						•	•			

**Construction Upgrades**

APC	ET	PE
•		•

**Door Options**

CG	DPSRR
•	•

**SINK BASE with TILT-OUT TRAYS,  
27" DEEP**

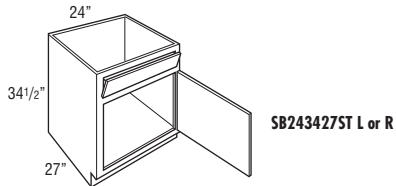

SB243427ST L or R

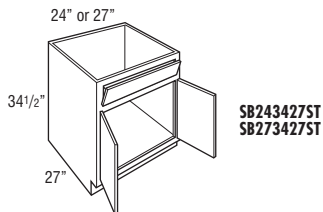

SB243427ST  
SB273427ST

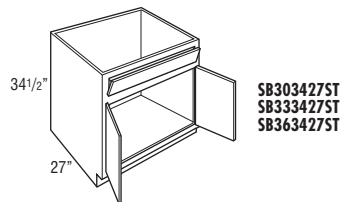

SB303427ST  
SB333427ST  
SB363427ST

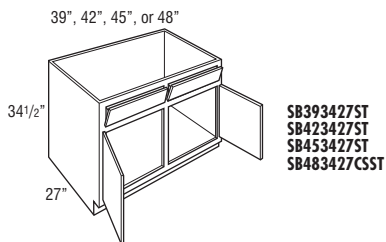

SB393427ST  
SB423427ST  
SB453427ST  
SB483427CSST

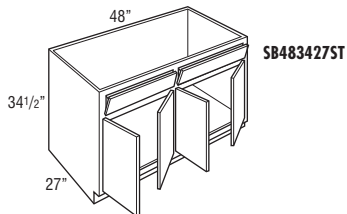

SB483427ST

Model	Cubic Feet
SB243427ST L or R	16.2
SB243427ST	16.2
SB273427ST	18.1
SB303427ST	19.9
SB333427ST	22.1
SB363427ST	23.7
SB393427ST	25.5
SB423427ST	27.5
SB453427ST	25.8
SB483427CSST	31.2
SB483427ST	31.2

- Tilt-out trays are stain resistant, moisture resistant plastic to allow storage of sponges and other cleaning materials.
- Mini Touch-up Kit (MTUK) included. MTUK includes small touch-up marker and small fill stick.
- Includes two tilt-out trays on 30"-48" wide.
- Tilt-out trays are also available as an accessory for field installation. See page 423.

**Custom Modifications**

AUTHL AUTHR	CBO	CCO	CFNTO	CFP	CFRMO	CMAT	CND	DRT	DRWPWR	DRWSEC	DRWTK	EXBKL EXBKR
•		•	•		•		•					•
EXL EXR	FB	FD	FFDL FFDR	FPEB	FTK	FTKAV FTKFV	ID	INVFRM	LTI	MIP	P	PTOWB
•	•			•	•	•			•	•	•	
RD	RECTKALL RECTKBK	RECTKL RECTKR	RT	SCDORW	TD	TOTSS TOTSSS	TVRAV TVRFV TVRVV	VTK	WLI			
	•	•						•	•			

**Construction Upgrades**

APC	ET	PE
•		•

**Door Options**

CG	DPSRR
•	•

**SINK BASE SUPERCABINET™**

L O G I X

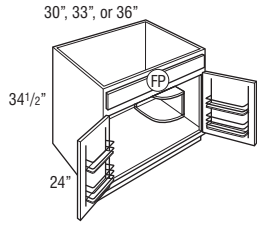

FP = False Panel

Model	Cubic Feet
<b>SB30S</b>	17.7
<b>SB33S</b>	19.6
<b>SB36S</b>	21.1

- Quarter Round Reversible Shelf for left or right applications will be constructed from 3/4" thick laminated furniture board. When upgraded to APC, shelf will use clear coated veneer plywood. (Shelf shipped secure, can be positioned in left or right corner.)
- Mini Touch-up Kit (MTUK) included. MTUK includes small touch-up marker and small fill stick.
- All load bearing surfaces meet KCMA standards of 15 lbs. per square foot.
- Each door features a chrome and wood two-tiered rack.
- Door rack width is 11 3/8" on 30" and 33" wide cabinets and 14 3/8" on 36" wide cabinet.
- Door rack depth is 3 1/2".

**Custom Modifications**

AUTHL AUTHR	CBO	CCO	CFNTD	CFP	CFRMO	CMAT	CND	DRT	DRWPWR	DRWSEC	DRWTK	EXBKL EXBKR
•	•	•	•	STD	•		•				•	•
EXL EXR	FB	FD	FFDL FFDR	FPEB	FTK	FTKAV FTKFV	ID	INVFRM	LTI	MIP	P	PTOWB
•	•		•	•	•	•	•		•	•		
RD	RECTKALL RECTKBK	RECTKL RECTKR	RT	SCPDRW	TD	TOTSS TOTSSS	TVRAV TVRFV TVRVV	VTK	WLI			
	•	•				•		•	•			

**Construction Upgrades**

APC	ET	PE
•		•

**Door Options**

CG	DPSRR
	•

**SINK BASE SUPERCABINET™ with CABMAT™**

L O G I X

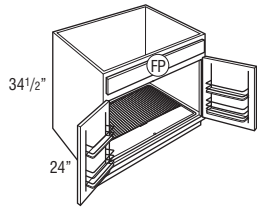

Model	Cubic Feet
<b>SB30SCM</b>	17.7
<b>SB33SCM</b>	19.6
<b>SB36SCM</b>	21.1

- Mini Touch-up Kit (MTUK) included. MTUK includes small touch-up marker and small fill stick.
- CabMat™ features a gray sloped mat to capture spills.
- CabMat™ is removable for cleaning.
- All load bearing surfaces meet KCMA standards of 15 lbs. per square foot.
- Each door features a chrome and wood two-tiered rack.
- Door rack width is 10 7/8" on 30" wide cabinet, 12 3/8" on 33" wide cabinet, and 13 7/8" on 36" wide cabinet.
- Door rack depth is 3 1/2".

Model	Liquid Capacity		Cabinet Size	
	Quarts	Liters	Width	Depth
SB30SCM	4.2	3.9	30"	24"
SB33SCM	4.6	4.3	33"	24"
SB36SCM	5.0	4.7	36"	24"

**Custom Modifications**

AUTHL AUTHR	CBO	CCO	CFNTD	CFP	CFRMO	CMAT	CND	DRT	DRWPWR	DRWSEC	DRWTK	EXBKL EXBKR
•	•	•	•	STD	•		•				•	•
EXL EXR	FB	FD	FFDL FFDR	FPEB	FTK	FTKAV FTKFV	ID	INVFRM	LTI	MIP	P	PTOWB
•	•		•	•	•	•	•		•	•		
RD	RECTKALL RECTKBK	RECTKL RECTKR	RT	SCPDRW	TD	TOTSS TOTSSS	TVRAV TVRFV TVRVV	VTK	WLI			
	•	•				•		•	•			

**Construction Upgrades**

APC	ET	PE
•		•

**Door Options**

CG	DPSRR
	•



**SINK BASE SUPERCABINET™ with CADDY**

L G I X

Model	Cubic Feet
<b>SB36SCDY L or R</b>	<b>20.9</b>

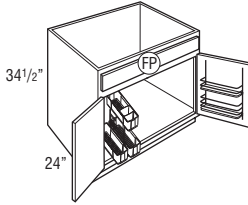

- Mini Touch-up Kit (MTUK) included. MTUK includes small touch-up marker and small fill stick.
- L or R designates caddy location.
- Caddy is removable and portable.
- Caddy dimensions are: 9 15/16" wide x 18 5/16" tall x 18 5/8" deep.
- Door opposite caddy features a chrome and wood two-tiered rack.
- Door rack width is 13 7/8".
- Door rack depth is 3 1/2".

**Custom Modifications**

AUTHL AUTHR	CBO	CCO	CFNTO	CFP	CFRMO	CMAT	CND	DRT	DRWPPWR	DRWSEC	DRWTK	EXBKL EXBKR
•	•	•	•	STD	•		•				•	•
EXL EXR	FB	FD	FFDL FFDR	FPEB	FTK	FTKAV FTKEV	ID	INVFRM	LTl	MIP	P	PTOWB
•	•		•	•	•	•	•		•	•		
RD	RECTKALL RECTKBK	RECTKL RECTKR	RT	SCPDRW	TD	TOTSS TOTSSS	TVRAV TVRFV TVRVV	VTK	WLI			
	•	•				•		•	•			

**Construction Upgrades**

APC	ET	PE
•		•

**Door Options**

CG	DPSRR
•	•

**SINK BASE SUPERCABINET™ with TILT-OUT TRAYS**

L G I X

<b>SB30STS</b>	<b>17.7</b>
<b>SB33STS</b>	<b>19.6</b>
<b>SB36STS</b>	<b>21.1</b>

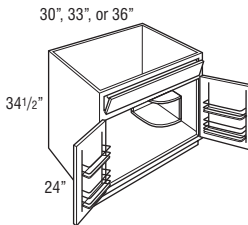

- Quarter Round Reversible Shelf for left or right applications will be constructed from 3/4" thick laminated furniture board. When upgraded to APC, shelf will use clear coated veneer plywood. (Shelf shipped secure, can be positioned in left or right corner.)
- Mini Touch-up Kit (MTUK) included. MTUK includes small touch-up marker and small fill stick.
- Includes two tilt-out trays.
- Tilt-out trays are stain resistant, moisture resistant plastic to allow storage of sponges and other cleaning materials.
- Tilt-out trays are also available as an accessory for field installation. See page 423.
- All load bearing surfaces meet KCMA standards of 15 lbs. per square foot.
- Each door features a chrome and wood two-tiered rack.
- Door rack width is 10 7/8" on 30" wide cabinet, 12 3/8" on 33" wide cabinet, and 13 7/8" on 36" wide cabinet.
- Door rack depth is 3 1/2".

**Custom Modifications**

AUTHL AUTHR	CBO	CCO	CFNTO	CFP	CFRMO	CMAT	CND	DRT	DRWPPWR	DRWSEC	DRWTK	EXBKL EXBKR
•	•	•	•		•		•				•	•
EXL EXR	FB	FD	FFDL FFDR	FPEB	FTK	FTKAV FTKEV	ID	INVFRM	LTl	MIP	P	PTOWB
•	•		•	•	•	•	•		•	•		
RD	RECTKALL RECTKBK	RECTKL RECTKR	RT	SCPDRW	TD	TOTSS TOTSSS	TVRAV TVRFV TVRVV	VTK	WLI			
	•	•						•	•			

**Construction Upgrades**

APC	ET	PE
•		•

**Door Options**

CG	DPSRR
	•

**SINK BASE SUPERCABINET™ with TILT-OUT TRAYS and CABMAT™**

L O G I X

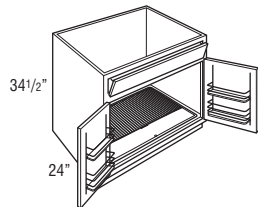

Model	Cubic Feet
SB30STSCM	17.7
SB33STSCM	19.6
SB36STSCM	21.1

- Mini Touch-up Kit (MTUK) included. MTUK includes small touch-up marker and small fill stick.
- CabMat™ features a gray sloped mat to capture spills.
- CabMat™ is removable for cleaning.
- Includes two tilt-out trays.
- Tilt-out trays are stain resistant, moisture resistant plastic to allow storage of sponges and other cleaning materials.
- Tilt-out trays are also available as an accessory for field installation. See page 423.
- All load bearing surfaces meet KCMA standards of 15 lbs. per square foot.
- Each door features a chrome and wood two-tiered rack.
- Door rack width is 10 7/8" on 30" wide cabinet, 12 3/8" on 33" wide cabinet, and 13 7/8" on 36" wide cabinet.
- Door rack depth is 3 1/2".

Model	Liquid Capacity		Cabinet Size	
	Quarts	Liters	Width	Depth
SB30STSCM	4.2	3.9	30"	24"
SB33STSCM	4.6	4.3	33"	24"
SB36STSCM	5.0	4.7	36"	24"

**Custom Modifications**

AUTHL AUTHR	CBO	CCO	CFNTO	CFP	CFRMO	CMAT	CND	DRT	DRWPWR	DRWSEC	DRWTK	EXBKL EXBKR
•	•	•	•	•	•	•	•	•	•	•	•	•
EXL EXR	FB	FD	FFDL FFDR	FPEB	FTK	FTKAV FTKFV	ID	INFRM	LTI	MIP	P	PTOWB
•	•	•	•	•	•	•	•	•	•	•	•	•
RD	RECTKALL RECTKBK	RECTKL RECTKR	RT	SCPDRW	TD	TOTSS TOTSSS	TVRAV TVRFV TVRVV	VTK	WLI			
•	•	•	•	•	•	•	•	•	•	•	•	•

**Construction Upgrades**

APC	ET	PE
•	•	•

**Door Options**

CG	DPSRR
•	•

**SINK BASE SUPERCABINET™ with TILT-OUT TRAYS and CADDY**

L O G I X

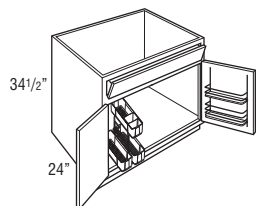

Model	Cubic Feet
SB36STSCDY L or R	20.9

- Mini Touch-up Kit (MTUK) included. MTUK includes small touch-up marker and small fill stick.
- L or R designates caddy location.
- Caddy is removable and portable.
- Includes two tilt-out trays.
- Tilt-out trays are stain resistant, moisture resistant plastic to allow storage of sponges and other cleaning materials.
- Tilt-out trays are also available as an accessory for field installation. See page 423.
- Caddy dimensions are: 9 15/16" wide x 18 5/16" tall x 18 5/8" deep.
- Door opposite caddy features a chrome and wood two-tiered rack.
- Door rack width is 13 7/8".
- Door rack depth is 3 1/2".

**Custom Modifications**

AUTHL AUTHR	CBO	CCO	CFNTO	CFP	CFRMO	CMAT	CND	DRT	DRWPWR	DRWSEC	DRWTK	EXBKL EXBKR
•	•	•	•	•	•	•	•	•	•	•	•	•
EXL EXR	FB	FD	FFDL FFDR	FPEB	FTK	FTKAV FTKFV	ID	INFRM	LTI	MIP	P	PTOWB
•	•	•	•	•	•	•	•	•	•	•	•	•
RD	RECTKALL RECTKBK	RECTKL RECTKR	RT	SCPDRW	TD	TOTSS TOTSSS	TVRAV TVRFV TVRVV	VTK	WLI			
•	•	•	•	•	•	•	•	•	•	•	•	•

**Construction Upgrades**

APC	ET	PE
•	•	•

**Door Options**

CG	DPSRR
•	•

**SINK BASE with DRAWER BELOW**

L G I X

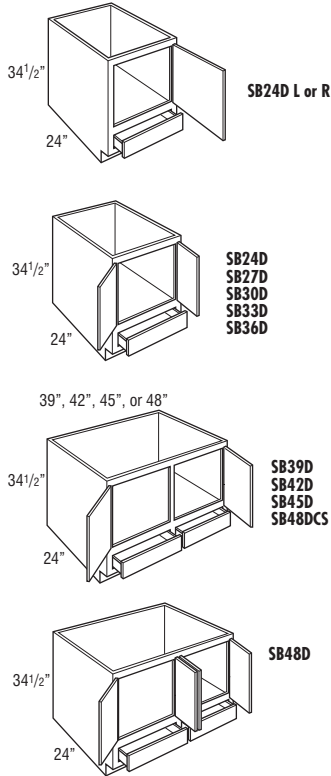

Model	Cubic Feet
<b>SB24D L or R</b>	14.4
<b>SB24D</b>	14.4
<b>SB27D</b>	16.1
<b>SB30D</b>	17.7
<b>SB33D</b>	19.6
<b>SB36D</b>	21.1
<b>SB39D</b>	22.7
<b>SB42D</b>	24.4
<b>SB45D</b>	25.8
<b>SB48DCS</b>	27.7
<b>SB48D</b>	27.7

- Drawers are below full cabinet floor.
- Mini Touch-up Kit (MTUK) included. MTUK includes small touch-up marker and small fill stick.
- Verify that sink, garbage disposal and plumbing fit opening.
- Plumbing going through floor will interfere with drawer operation. 2 3/4" clearance from back of drawer to interior back of cabinet.
- Face frame opening height is 20 1/2".
- Face frame opening height for drawer is 4 1/2".

**Custom Modifications**

AUTHL AUTHR	CBO	CCO	CFNTD	CFP	CFRMO	CMAT	CND	DRT	DRWPWR	DRWSEC	DRWTK	EXBKL EXBKR
•	•	•			•	•*	•				•*	•
EXL EXR	FB	FD	FFDL FFDR	FPEB	FTK	FTKAV FTKFV	ID	INVFRM	LTl	MIP	P	PTOWB
•	•			•	•	•			•	•	•	
RD	RECTKALL RECTKBK	RECTKL RECTKR	RT	SCPDRW	TD	TOTSS TOTSSS	TVRAV TVRFV TVRVV	VTk	WLI			
•	•	•						•	•			

\*Available only on 30", 33", and 36" wide \*Not available on 39", 42", 45", and 48" wide

**Construction Upgrades**

APC	ET	PE
•		•

**Door Options**

CG	DPSRR
•	•

**SINK FRONT BOTTOM**

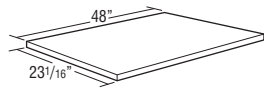

SFB48	1.0
-------	-----

- Designed for use with Sink Bases ordered with CFNTD.
- 3/8" thick.
- Trimmable.

**Custom Modifications**

AUTHL AUTHR	CBO	CCO	CFNTD	CFP	CFRMO	CMAT	CND	DRT	DRWPWR	DRWSEC	DRWTK	EXBKL EXBKR
EXL EXR	FB	FD	FFDL FFDR	FPEB	FTK	FTKAV FTKFV	ID	INVFRM	LTl	MIP	P	PTOWB
RD	RECTKALL RECTKBK	RECTKL RECTKR	RT	SCPDRW	TD	TOTSS TOTSSS	TVRAV TVRFV TVRVV	VTk	WLI			
									•			

**Construction Upgrades**

APC	ET	PE
•		

**Door Options**

CG	DPSRR

**SQUARE CORNER SINK BASE**

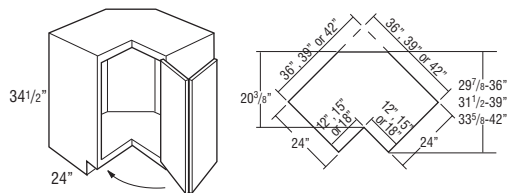

Model	Cubic Feet
<b>CS36 L or R</b>	25.9
<b>CS39 L or R</b>	33.7
<b>CS42 L or R</b>	38.9

- CS36: Wall width: 36" x 36". Frame 12" x 12".
- CS39: Wall width: 39" x 39". Frame 15" x 15".
- CS42: Wall width: 42" x 42". Frame 18" x 18".
- Mini Touch-up Kit (MTUK) included. MTUK includes small touch-up marker and small fill stick.
- For sufficient dishwasher door clearance and loading/unloading space, a 15" wide base cabinet is recommended for use between a corner sink base and dishwasher.
- Decorative hardware screws must be countersunk to prevent scratching of adjacent cabinets and face frame of CS.
- Integrated soft-close hinge not included.

**Custom Modifications**

AUTHL AUTHR	CBO	CCO	CFNTO	CFP	CFRMO	CMAT	CND	DRT	DRWPWR	DRWSEC	DRWTK	EXBKL EXBKR
•		•										
EXL EXR	FB	FD	FFDL FFDR	FPEB	FTK	FTKAV FTKRV	ID	INVFRM	LTI	MIP	P	PTOWB
	•			•						•		
RD	RECTKALL RECTKBK	RECTKL RECTKR	RT	SCPDWR	TD	TOTSS TOTSSS	TAVR TVRFV TVRVV	VTK	WLI			
	•	•						•	•			

**Construction Upgrades**

APC	ET	PE
•		•

**Door Options**

CG	DPSRR
	•

**ANGLED CORNER SINK BASE**

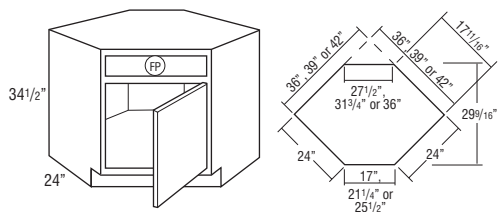

Ⓢ = False Panel

Max. Sink Widths if cut-out is 4" back from face of front frame

<b>ACS36 L or R</b>	25.9
<b>ACS39 L or R</b>	33.7
<b>ACS42<sup>†</sup></b>	38.9

- Edges beveled at 45°.
- Mini Touch-up Kit (MTUK) included. MTUK includes small touch-up marker and small fill stick.
- For sufficient dishwasher door clearance and loading/unloading space, a 15" wide base cabinet is recommended for use between a corner sink base and dishwasher.
- Full overlay styles use HINGEORPO, see page 429.
- <sup>†</sup>ACS42 has butt doors.

Model	Wall Width	Frame	Maximum Sink Width	Maximum Sink Depth
ACS36	36" x 36"	17"	25 3/4"	27 11/32"
ACS39	39" x 39"	21 1/4"	30"	27 11/32"
ACS42	42" x 42"	25 1/2"	34 1/4"	27 11/32"

**Custom Modifications**

AUTHL AUTHR	CBO	CCO	CFNTO	CFP	CFRMO	CMAT	CND	DRT	DRWPWR	DRWSEC	DRWTK	EXBKL EXBKR
•		•	•	STD	•		•					
EXL EXR	FB	FD	FFDL FFDR	FPEB	FTK	FTKAV FTKRV	ID	INVFRM	LTI	MIP	P	PTOWB
	•			•	•	•				•		
RD	RECTKALL RECTKBK	RECTKL RECTKR	RT	SCPDWR	TD	TOTSS TOTSSS	TAVR TVRFV TVRVV	VTK	WLI			
	•	•						•	•			

**Construction Upgrades**

APC	ET	PE
•		•

**Door Options**

CG	DPSRR
•	•

### ANGLED CORNER SINK FRONT without SINK FLOOR

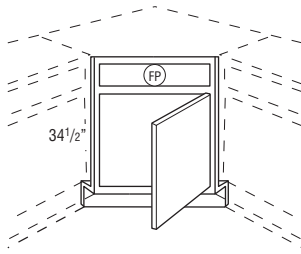

FP = False Panel

Max. Sink Widths if cut-out is 4" back from face of front frame

Model	Cubic Feet
ACSF36 L or R	3.3
ACSF39 L or R	3.3
ACSF42†	3.3

- Edges beveled at 45°.
  - Angled corner sink front bottom required for field installation. Order separately. See next item.
  - Toekick and toekick retainer shipped unattached from the face frame.
  - Full overlay styles use HINGEQRPO, see page 429.
- †ACSF42 has butt doors.

Model	Wall Width	Frame	Maximum Sink Width	Maximum Sink Depth
ACSF36	36" x 36"	17"	25 3/4"	27 11/32"
ACSF39	39" x 39"	21 1/4"	30"	27 11/32"
ACSF42	42" x 42"	25 1/2"	34 1/4"	27 11/32"

#### Custom Modifications

AUTHL AUTHR	CBO	CCO	CFNTO	CFP	CFRMO	CMAT	CND	DRT	DRWPWR	DRWSEC	DRWTK	EXBKL EXBKR
			STD	STD	•		•					
EXL EXR	FB	FD	FFDL FFDR	FPEB	FTK	FTKAV FTKFV	ID	INVFRM	LTI	MIP	P	PTOWB
					•	•			•			
RD	RECTKALL RECTKBK	RECTKL RECTKR	RT	SCPDRW	TD	TOTSS TOTSSS	TVRAV TVRFV TVRVV	VTK	WLI			

#### Construction Upgrades

APC	ET	PE

#### Door Options

CG	DPSRR
	•

### ANGLED CORNER SINK FRONT BOTTOM

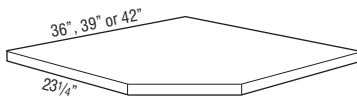

ACSF36	1.0
ACSF39	1.0
ACSF42	1.0

- Designed for use with Angled Corner Sink Front.
- Cabinet bottom is sized for use next to an adjacent wall or cabinet with flush ends.
- 3/8" thick.

#### Custom Modifications

AUTHL AUTHR	CBO	CCO	CFNTO	CFP	CFRMO	CMAT	CND	DRT	DRWPWR	DRWSEC	DRWTK	EXBKL EXBKR
EXL EXR	FB	FD	FFDL FFDR	FPEB	FTK	FTKAV FTKFV	ID	INVFRM	LTI	MIP	P	PTOWB
RD	RECTKALL RECTKBK	RECTKL RECTKR	RT	SCPDRW	TD	TOTSS TOTSSS	TVRAV TVRFV TVRVV	VTK	WLI			
									•			

#### Construction Upgrades

APC	ET	PE
•		

#### Door Options

CG	DPSRR

**COUNTRY SINK BASE**

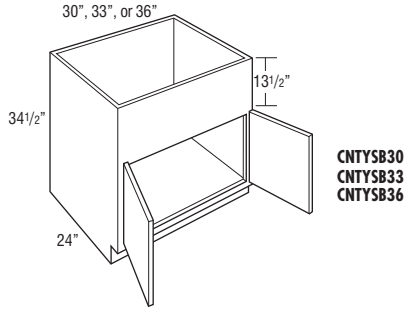

CNTYSB30  
CNTYSB33  
CNTYSB36

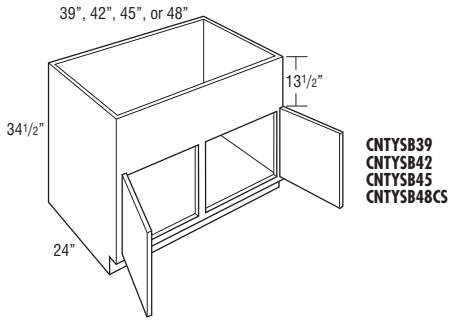

CNTYSB39  
CNTYSB42  
CNTYSB45  
CNTYSB48CS

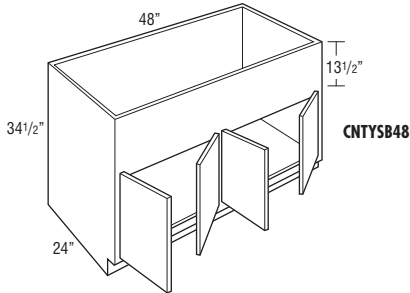

CNTYSB48

Model	Cubic Feet
CNTYSB30	17.7
CNTYSB33	19.6
CNTYSB36	21.1
CNTYSB39	22.7
CNTYSB42	24.4
CNTYSB45	25.8
CNTYSB48CS	27.7
CNTYSB48	27.7

- 13 1/2" panel can be trimmed up to 12".
- Mini Touch-up Kit (MTUK) included. MTUK includes small touch-up marker and small fill stick.
- For apron front sinks requiring smaller cut-out heights, see Country Sink Base with Short Apron on page 213 or Base Drop-in Range Cabinets on page 245.
- Refer to sink manufacturer's recommendations for additional support required for apron front sinks.

**Custom Modifications**

AUTHL AUTHR	CBO	CCO	CFNTO	CFP	CFRMO	CMAT	CND	DRT	DRWPWR	DRWSEC	DRWTK	EXBKL EXBKR
•		•	•		•	•*					•*	•
EXL EXR	FB	FD	FFDL FFDR	FPEB	FTK	FTKAV FTKFV	ID	INVFRM	LTI	MIP	P	PTOWB
•	•			•	•	•	•			•		
RD	RECTKALL RECTKBK	RECTKL RECTKR	RT	SCPDWR	TD	TOTSS TOTSSS	TVRAV TVRFV TVRVV	VTK	WLI			
•	•	•	•						•	•		

\*Available only on 30", 33", and 36" wide \*Not available on 39", 42", 45", and 48" wide

**Construction Upgrades**

APC	ET	PE
•		•

**Door Options**

CG	DPSRR
•	•

**COUNTRY SINK BASE with CABMAT™** L O G I X

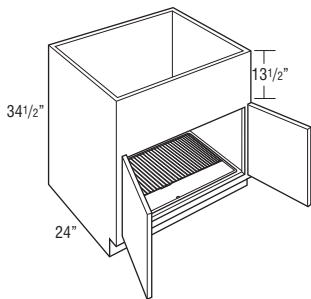

CNTYSB30CM	17.7
CNTYSB33CM	19.6
CNTYSB36CM	21.1

- Mini Touch-up Kit (MTUK) included. MTUK includes small touch-up marker and small fill stick.
- CabMat™ features a gray sloped mat to capture spills.
- CabMat™ is removable for cleaning.
- 13 1/2" panel can be trimmed to 12".
- For apron front sinks requiring smaller cut-out heights, see Country Sink Base with Short Apron on page 213 or Base Drop-in Range Cabinets on page 245.
- Refer to sink manufacturer's recommendations for additional support required for apron front sinks.

Model	Liquid Capacity		Cabinet Size	
	Quarts	Liters	Width	Depth
CNTYSB30CM	4.2	3.9	30"	24"
CNTYSB33CM	4.6	4.3	33"	24"
CNTYSB36CM	5.0	4.7	36"	24"

**Custom Modifications**

AUTHL AUTHR	CBO	CCO	CFNTO	CFP	CFRMO	CMAT	CND	DRT	DRWPWR	DRWSEC	DRWTK	EXBKL EXBKR
•	•	•	•		•						•	•
EXL EXR	FB	FD	FFDL FFDR	FPEB	FTK	FTKAV FTKFV	ID	INVFRM	LTI	MIP	P	PTOWB
•	•			•	•	•	•			•		
RD	RECTKALL RECTKBK	RECTKL RECTKR	RT	SCPDWR	TD	TOTSS TOTSSS	TVRAV TVRFV TVRVV	VTK	WLI			
	•	•							•	•		

**Construction Upgrades**

APC	ET	PE
•		•

**Door Options**

CG	DPSRR
	•



## COUNTRY SINK BASE with SHORT APRON

30", 33", or 36"

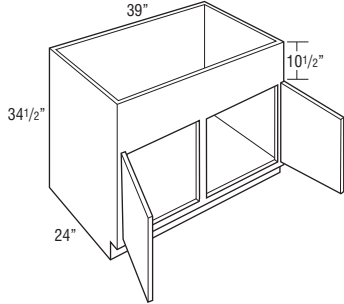
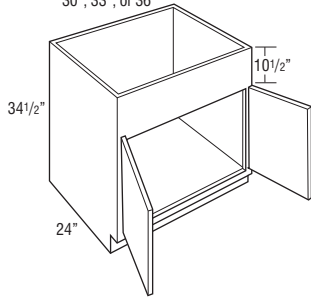

Model	Cubic Feet
CNTYSB30SA	17.7
CNTYSB33SA	19.6
CNTYSB36SA	21.1
CNTYSB39SA	22.7

- 10 1/2" panel can be trimmed up to 9".
- Mini Touch-up Kit (MTUK) included. MTUK includes small touch-up marker and small fill stick.
- For apron front sinks requiring a cut-out height of 6 1/2" or less, see Base Drop-in Range Cabinets on page 245.
- Refer to sink manufacturer's recommendations for additional support required for apron front sinks.

### Custom Modifications

AUTHL	CBO	CCO	CFNTD	CFP	CFRMO	CMAT	CND	DRT	DRWPWR	DRWSEC	DRWTK	EXBKL		
AUTHR												EXBKR		
•		•	•		•	•*					•*	•		
EXL	FB	FD	FFDL	FPEB	FTK	FTKAV	ID	INVFRM	LTI	MIP	P	PTOWB		
EXR			FFDR			FTKFV								
•	•			•	•	•	•		•	•				
RD	RECTKALL	RECTKLBK	RECTKL	RECTKR	RT	SCPDWR	TD	TOTSS	TOTSSS	TVRAV	TVRFV	TVRVV	VTK	WLI
•	•	•	•	•							•	•		•

\*Not available on 39" wide

### Construction Upgrades

APC	ET	PE
•		•

### Door Options

CG	DPSRR
•	•

## Sink Base Corner Cabinets

- SBCs use the wall space the nomenclature implies.
- Remember to use 3" filler on adjoining cabinets.
- The adjoining run of cabinets will cover the void.
- The L or R in the cabinet nomenclature indicates the location of the void to ensure clearance; it is not recommended to place SBC cabinets next to 27" deep appliances.

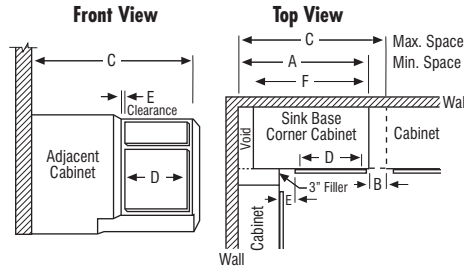

Model	A Min. Space	B Max. Pull*	C Max. Space	D Cabinet Opening	E* Full Overlay**		E* Partial Overlay		F Actual Cabinet
					At Min.	At Max.	At Min.	At Max.	
SBC51	51"	4 1/2"	55 1/2"	21"	3 1/4"	7 3/4"	4"	8 1/2"	48"
SBC54	54"	4 1/2"	58 1/2"	24"	3 1/4"	7 3/4"	4"	8 1/2"	51"
SBC57	57"	4 1/2"	61 1/2"	27"	3 1/4"	7 3/4"	4"	8 1/2"	54"
SBC60	60"	4 1/2"	64 1/2"	30"	3 1/4"	7 3/4"	4"	8 1/2"	57"
SBC63	63"	4 1/2"	67 1/2"	33"	3 1/4"	7 3/4"	4"	8 1/2"	60"

\*Minimum/maximum space between inside edge of door and face of filler/adjoining cabinet. If cabinet is pulled to maximum stated dimension, filler will need to be cleated for proper attachment.

\*\*Full overlay styles must be pulled an additional 1 1/2" to ensure proper drawer/pull clearance. 1 1/2" pull is not included in minimum and maximum list.

214

BASE CABINETS

## NEW SINK BASE BLIND CORNER

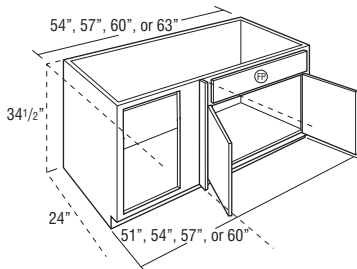
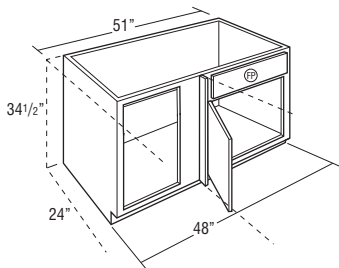

Model	Cubic Feet
SBC51 L or R	27.3
SBC54 L or R	29.0
SBC57 L or R	30.6
SBC60 L or R	32.3
SBC63 L or R	34.0

- Not recommended for use next to an appliance deeper than standard cabinet depth.
- Includes one 3" filler, shipped unattached.
- L or R indicates void. L (left) void shown.
- Face Frame and Door on End modification not available on the void side of the cabinet.
- Mini Touch-up Kit (MTUK) included. MTUK includes small touch-up marker and small fill stick.

### Custom Modifications

AUTHL AUTHR	CBO	CCO	CFNTD	CFP	CFRMO	CMAT	CND	DRT	DRWPWR	DRWSEC	DRWTK	EXBKL EXBKR
•		•	•	STD	•		•					•
EXL EXR	FB	FD	FFDL FFDR	FPEB	FTK	FTKAV FTKFV	ID	INVFRM	LTI	MIP	P	PTOWB
•	•		•	•	•		•		•	•		
RD	RECTKALL RECTKBK	RECTKL RECTKR	RT	SCPDRW	TD	TOTSS TOTSSS	TVRAV TVRFV TVRVV	VTK	WLI			
•	•	•				•		•	•			

### Construction Upgrades

APC	ET	PE
•		•

### Door Options

CG	DPSRR
•	•



**Base Corner Cabinets**

- BCs use the wall space the nomenclature implies.
- Remember to use 3" filler on adjoining cabinets.
- The adjoining run of cabinets will cover the void.
- BCFW specifies full width blind corner base cabinet.
- The L or R in the cabinet nomenclature indicates the location of the void to ensure clearance; it is not recommended to place BC cabinets next to 27" deep appliances.

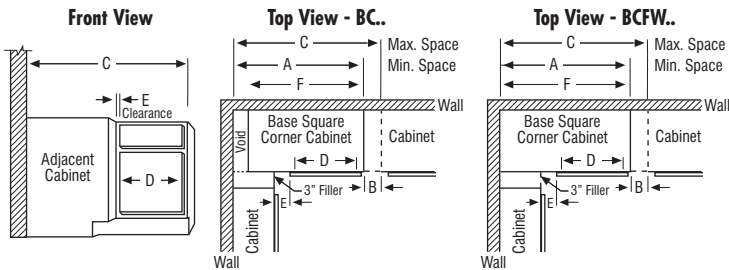

Model	A Min. Space	B Max. Pull*	C Max. Space	D Cabinet Opening	E* Full Overlay** At Min. At Max.		E* Partial Overlay At Min. At Max.		F Actual Cabinet
BC36	36"	6"	42"	7 1/2"	1 3/4"	7 3/4"	2 1/2"	8 1/2"	27"
BC39	39"	4 1/2"	43 1/2"	9"	3 1/4"	7 3/4"	4"	8 1/2"	30"
BC42	42"	6"	48"	13 1/2"	1 3/4"	7 3/4"	2 1/2"	8 1/2"	39"
BC45/BC45PO	45"	4 1/2"	49 1/2"	15"	3 1/4"	7 3/4"	4"	8 1/2"	42"
BC48/BC48PO	48"	3"	51"	16 1/2"	4 1/4"	7 3/4"	5 1/2"	8 1/2"	45"
BCFW36	36"	5"	41"	7 1/2"	1 3/4"	6 3/4"	2 1/4"	7 1/2"	36"
BCFW39	39"	3 1/2"	42 1/2"	9"	3 1/4"	6 3/4"	4"	7 1/2"	39"
BCFW42	42"	9"	51"	13 1/2"	1 3/4"	10 3/4"	2 1/2"	11 1/2"	42"
BCFW45/BCFW45PO	45"	7 1/2"	52 1/2"	15"	3 1/4"	10 3/4"	4"	11 1/2"	45"
BCFW48/BCFW48CPO/BCFW48PO	48"	4 1/2"	52 1/2"	18"	3 1/4"	7 3/4"	4"	8 1/2"	48"
BCFW48SP	48"	4 1/2"	52 1/2"	18"	3 1/4"	7 3/4"	4"	8 1/2"	48"

\*Minimum/maximum space between inside edge of door and face of filler/adjoining cabinet. If cabinet is pulled to maximum stated dimension, filler will need to be cleated for proper attachment.

\*\*Full overlay styles must be pulled an additional 1 1/2" to ensure proper drawer/pull clearance. 1 1/2" pull is not included in minimum and maximum list.

**BASE CORNER**

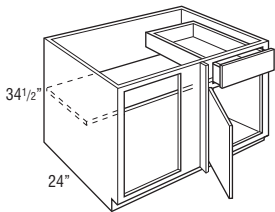

- BC36 L or R - 27" wide
- BC39 L or R - 30" wide
- BC42 L or R - 39" wide
- BC45 L or R - 42" wide
- BC48 L or R - 45" wide

Model	Cubic Feet
BC36 L or R	16.1
BC39 L or R	19.6
BC42 L or R	24.4
BC45 L or R	24.4
BC48 L or R	26.0

- Not recommended for use next to an appliance deeper than standard cabinet depth.
- Includes one 3" filler, shipped unattached.
- L or R indicates void. L (left) void shown.
- Adjustable 15" deep shelves.
- Face Frame and Door on End modification not available on the void side of the cabinet.

**Custom Modifications**

AUTHL AUTHR	CBO	CCO	CFNTO	CFP	CFRMO	CMAT	CND	DRT	DRWPWR	DRWSEC	DRWTK	EXBKL EXBKR
•	•	•	•	•	•		•		•*	•*		•
EXL EXR	FB	FD	FFDL FFDR	FPEB	FTK	FTKAV FTKRV	ID	INVFRM	LTI	MIP	P	PTOWB
•	•	•	•	•	•				•▲	•		
RD	RECTKALL RECTKBK	RECTKL RECTKR	RT	SCPRW	TD	TOTSS TOTSSS	TAVRAV TVRFV TVRVV	VTK	WLI			
•	•	•						•	•			

\*Not available on 36", 39", and 42" wide    \*Available only on 45" wide    ▲Not available on 36" and 39" wide

**Construction Upgrades**

APC	ET	PE
•		•

**Door Options**

CG	DPSRR
•	•

**BASE CORNER with PULL-OUT**

L O G I X

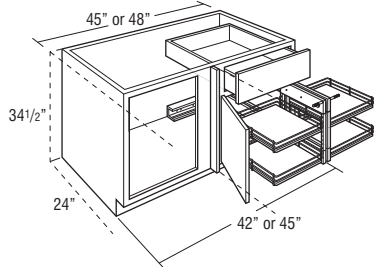

BC45PO L or R  
BC48PO L or R

Model	Cubic Feet
BC45PO L or R	24.4
BC48PO L or R	26.0

- Not recommended for use next to an appliance deeper than standard cabinet depth.
- Cannot be installed next to a wall.
- Pull-out features four wood shelves with chrome surround. Smart Stop not available.
- Includes one 3" filler, shipped unattached.
- L or R indicates void. L (left) void shown.
- Adjacent cabinet hardware may interfere with shelf position or pull-out.
- Wire pull-out dimensions are 10 5/8" W x 17 1/8" D x 2 3/4" H.
- For pull-out to open, 10" of adjacent space is required with no obstruction beyond 1" in front of the cabinet face frame.
- Face Frame and Door on End modification not available on the void side of the cabinet.

**Custom Modifications**

AUTHL AUTHR	CBO	CCO	CFNTO	CFP	CFRMO	CMAT	CND	DRT	DRWPWR	DRWSEC	DRWTK	EXBKL EXBKR
•	•	•	•	•	•		•		•			•
EXL EXR	FB	FD	FFDL FFDR	FPEB	FTK	FTKAV FTKFV	ID	INVFRM	LTI	MIP	P	PTOWB
•	•		•	•	•					•		
RD	RECTKALL RECTKBK	RECTKL RECTKR	RT	SCPDRW	TD	TOTSS TOTSSS	TVRAV TVRFV TVRVV	VTK	WLI			
	•	•						•	•			

**Construction Upgrades**

APC	ET	PE
•		•

**Door Options**

CG	DPSRR
•	•

**BASE CORNER FULL WIDTH**

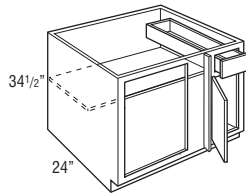

BCFW36 L or R - 36" wide  
BCFW39 L or R - 39" wide

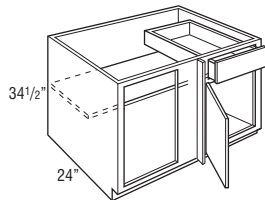

BCFW42 L or R - 42" wide  
BCFW45 L or R - 45" wide  
BCFW48 L or R - 48" wide

BCFW36 L or R	21.1
BCFW39 L or R	22.7
BCFW42 L or R	24.4
BCFW45 L or R	26.0
BCFW48 L or R	27.7

- Not recommended for use next to an appliance deeper than standard cabinet depth.
- Includes one 3" filler, shipped unattached.
- L or R indicates void. L (left) void shown.
- Adjustable 15" deep shelves.
- Face Frame and Door on End modification not available on the void side of the cabinet.

**Custom Modifications**

AUTHL AUTHR	CBO	CCO	CFNTO	CFP	CFRMO	CMAT	CND	DRT	DRWPWR	DRWSEC	DRWTK	EXBKL EXBKR
•	•	•	•	•	•		•		•*	•+		•
EXL EXR	FB	FD	FFDL FFDR	FPEB	FTK	FTKAV FTKFV	ID	INVFRM	LTI	MIP	P	PTOWB
•	•		•	•	•				•▲	•		
RD	RECTKALL RECTKBK	RECTKL RECTKR	RT	SCPDRW	TD	TOTSS TOTSSS	TVRAV TVRFV TVRVV	VTK	WLI			
•	•	•						•	•			

\*Not available on 36", 39", and 42" wide    \*Available only on 45" and 48" wide    ▲Not available on 36" and 39" wide

**Construction Upgrades**

APC	ET	PE
•		•

**Door Options**

CG	DPSRR
•	•

**BASE CORNER FULL WIDTH with CURVED PULL-OUT**

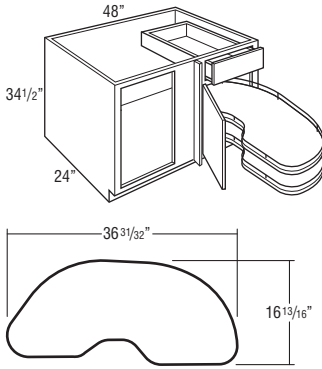

L G I X

Model	Cubic Feet
BCFW48CPO L or R	27.7

- Includes one 3" filler, shipped unattached.
- Includes two pull-out shelves with chrome wire surround and Smart Stop closing mechanism. Shelf height can be adjusted in the field.
- When shelf is fully opened, it extends 27 3/4" from front edge of the face frame. Unit pulls out to the front only and can be installed next to a wall or appliance without side interference.
- Distance from surface of shelf to top edge of wire surround is 1 11/16".
- L or R indicates void. L (left) void shown.
- Maximum Weight Capacity: 44 lbs. per shelf.
- Face Frame and Door on End modification not available on the void side of the cabinet.

**Custom Modifications**

AUTHL AUTHR	CBO	CCO	CFNT0	CFP	CFRMO	CMAT	CND	DRT	DRWPWR	DRWSEC	DRWTK	EXBKL EXBKR
•	•	•	•	•	•		•		•	•		•
EXL EXR	FB	FD	FFDL FFDR	FPEB	FTK	FTKAV FTKRV	ID	INVFRM	LTI	MIP	P	PTOWB
•	•		•	•	•					•		
RD	RECTKALL RECTKBK	RECTKL RECTKR	RT	SCPDRW	TD	TOTSS TOTSSS	TVRAV TVRFV TVRVV	VTK	WLI			
	•	•						•	•			

**Construction Upgrades**

APC	ET	PE
•		•

**Door Options**

CG	DPSRR
	•

**BASE CORNER FULL WIDTH with PULL-OUT**

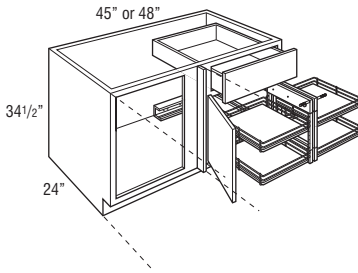

L G I X

BCFW45PO L or R	26.0
BCFW48PO L or R	27.7

- Not recommended for use next to an appliance deeper than standard cabinet depth.
- Cannot be installed next to a wall.
- Includes one 3" filler, shipped unattached.
- L or R indicates void. L (left) void shown.
- Pull-out features four wood shelves with chrome surround. Smart Stop not available.
- Wire pull-out interior dimensions are 10 5/8" W x 17 1/8" D x 2 3/4" H.
- For pull-out to open, 10" of adjacent space is required with no obstruction beyond 1" in front of the cabinet face frame.
- Adjacent cabinet hardware may interfere with shelf position on pull-out.
- Face Frame and Door on End modification not available on the void side of the cabinet.

**Custom Modifications**

AUTHL AUTHR	CBO	CCO	CFNT0	CFP	CFRMO	CMAT	CND	DRT	DRWPWR	DRWSEC	DRWTK	EXBKL EXBKR
•	•	•	•	•	•		•		•	•		•
EXL EXR	FB	FD	FFDL FFDR	FPEB	FTK	FTKAV FTKRV	ID	INVFRM	LTI	MIP	P	PTOWB
•	•		•	•	•					•		
RD	RECTKALL RECTKBK	RECTKL RECTKR	RT	SCPDRW	TD	TOTSS TOTSSS	TVRAV TVRFV TVRVV	VTK	WLI			
	•	•						•	•			

**Construction Upgrades**

APC	ET	PE
•		•

**Door Options**

CG	DPSRR
•	•

**BASE CORNER FULL WIDTH with ROLL TRAYS & SWING-OUT** L O G I X

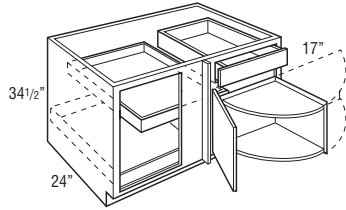

Model	Cubic Feet
<b>BCFW48SP L or R</b>	<b>27.7</b>

- Not recommended for use next to an appliance deeper than standard cabinet depth.
- Includes one 3" filler, shipped unattached.
- L or R indicates void. L (left) void shown.
- Swing-out hinged opposite door.
- Roll trays and swing-outs installed.
- Insert swing on a base corner full width cabinet is 17"; do not install next to a wall or appliance.
- Swing-out is 3/4" laminated furniture board.

**Custom Modifications**

AUTHL AUTHR	CBO	CCO	CFNT0	CFP	CFRMO	CMAT	CND	DRT	DRWPWR	DRWSEC	DRWTK	EXBKL EXBKR
•	•	•	•	•	•		•		•	•		•
EXL EXR	FB	FD	FFDL FFDR	FPEB	FTK	FTKAV FTKFV	ID	INVFRM	LTI	MIP	P	PTOWB
•	•			•	•					•		
RD	RECTKALL RECTKBK	RECTKL RECTKR	RT	SCPDRW	TD	TOTSS TOTSSS	TVRAV TVRFV TVRVV	VTK	WLI			
	•	•						•	•			

**Construction Upgrades**

APC	ET	PE
•		•

**Door Options**

CG	DPSRR
•	•

**BASE LAZY SUSAN CORNER (With Revolving Door) (Partial Overlay styles only)**

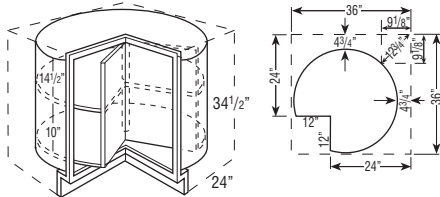

Model	Cubic Feet
<b>BLS36DR</b>	<b>20.0</b>

- BLS36DR wall width is 36" x 36".
- Cabinet is drum-shaped; adjoining cabinets create sides.
- BLS white plastic shelves are 28" diameter with a chrome pole.
- See Panels & Skins section for BLS BEP if used at end of cabinet run.
- Available in partial overlay styles only.
- If ordered with PE or APC, construction will not change.
- Drum diameter is 31 1/8" and composed of 1/8" thick hardboard.
- Integrated soft-close hinge not included.

**Custom Modifications**

AUTHL AUTHR	CBO	CCO	CFNT0	CFP	CFRMO	CMAT	CND	DRT	DRWPWR	DRWSEC	DRWTK	EXBKL EXBKR
	•	•										
EXL EXR	FB	FD	FFDL FFDR	FPEB	FTK	FTKAV FTKFV	ID	INVFRM	LTI	MIP	P	PTOWB
RD	RECTKALL RECTKBK	RECTKL RECTKR	RT	SCPDRW	TD	TOTSS TOTSSS	TVRAV TVRFV TVRVV	VTK	WLI			

**Construction Upgrades**

APC	ET	PE

**Door Options**

CG	DPSRR
	•

**BASE LAZY SUSAN CORNER with FULL HEIGHT DOOR and LAZY SUSAN (With Center Hinge Door)**

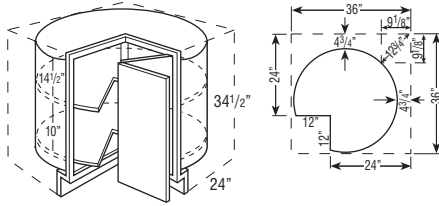

Model	Cubic Feet
<b>BLS36 L or R</b>	<b>20.0</b>

- BLS36 L or R wall width is 36" x 36".
- Cabinet is drum-shaped; adjoining cabinets create sides.
- BLS white plastic shelves are 28" diameter with a chrome pole.
- See Panels & Skins section for BLS BEP if used at end of cabinet run.
- If ordered with PE or APC, construction will not change.
- Drum diameter is 31 1/8" and composed of 1/8" thick hardboard.
- Decorative hardware screws must be countersunk to prevent scratching of adjacent cabinets and face frame of BLS.
- Integrated soft-close hinge not included.

**Custom Modifications**

AUTHL AUTHR	CBO	CCO	CFNT0	CFP	CFRMO	CMAT	CND	DRT	DRWPWR	DRWSEC	DRWTK	EXBKL EXBKR
	•	•										
EXL EXR	FB	FD	FFDL FFDR	FPEB	FTK	FTKAV FTKRV	ID	INVFRM	LTl	MIP	P	PTOWB
RD	RECTKALL RECTKBK	RECTKL RECTKR	RT	SCPDRW	TD	TOTSS TOTSSS	TVRAV TVRFV TVRVV	VTK	WLI			

**Construction Upgrades**

APC	ET	PE

**Door Options**

CG	DPSRR
	•

**DIAGONAL BASE with FULL HEIGHT DOOR**

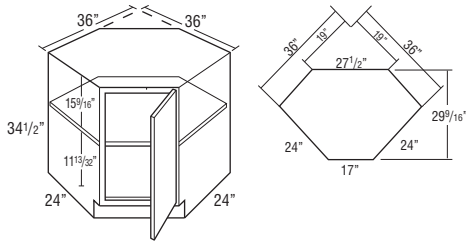

Model	Cubic Feet
<b>DAB36FS L or R</b>	<b>25.9</b>

- One fixed 1/2" thick shelf.
- Full overlay styles use HINGEQRP0, see page 429.

**Custom Modifications**

AUTHL AUTHR	CBO	CCO	CFNT0	CFP	CFRMO	CMAT	CND	DRT	DRWPWR	DRWSEC	DRWTK	EXBKL EXBKR
	•	•	•		•							
EXL EXR	FB	FD	FFDL FFDR	FPEB	FTK	FTKAV FTKRV	ID	INVFRM	LTl	MIP	P	PTOWB
				•	•	•			•	•		
RD	RECTKALL RECTKBK	RECTKL RECTKR	RT	SCPDRW	TD	TOTSS TOTSSS	TVRAV TVRFV TVRVV	VTK	WLI			
	•	•						•	•			

**Construction Upgrades**

APC	ET	PE
•		•

**Door Options**

CG	DPSRR
•	•

**DIAGONAL BASE with FULL HEIGHT DOOR & SUPER LAZY SUSAN**

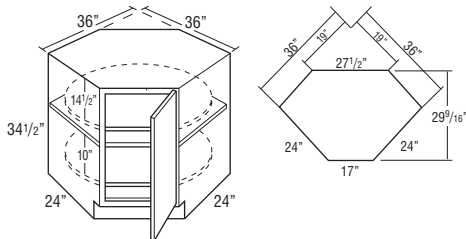

Due to fixed shelf mounting, shelves cannot be retrofitted.

Model	Cubic Feet
<b>DAB36SLS L or R</b>	<b>25.9</b>

- Features two 28" plywood revolving shelves with a 1" plywood lip. Lower shelf is mounted to floor. Upper shelf is mounted to fixed shelf. Fixed shelf is 1/2" thick laminated furniture board.
- Full overlay styles use HINGEQRP0, see page 429.

**Custom Modifications**

AUTHL AUTHR	CBO	CCO	CFNT0	CFP	CFRMO	CMAT	CND	DRT	DRWPWR	DRWSEC	DRWTK	EXBKL EXBKR
	•	•	•		•							
EXL EXR	FB	FD	FFDL FFDR	FPEB	FTK	FTKAV FTKRV	ID	INVFRM	LTl	MIP	P	PTOWB
				•	•	•			•	•		
RD	RECTKALL RECTKBK	RECTKL RECTKR	RT	SCPDRW	TD	TOTSS TOTSSS	TVRAV TVRFV TVRVV	VTK	WLI			
	•	•						•	•			

**Construction Upgrades**

APC	ET	PE
•		•

**Door Options**

CG	DPSRR
•	•

**BASE EASY REACH**

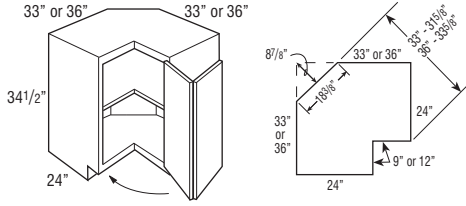

Model	Cubic Feet
<b>BER33 L or R</b>	<b>24.0</b>
<b>BER36 L or R</b>	<b>25.9</b>

- BER33 L or R wall width is 33" x 33". BER36 L or R wall width is 36" x 36".
- Decorative hardware screws must be countersunk to prevent scratching of adjacent cabinets and face frame of BER.
- Fixed shelf is 1/2" thick laminated furniture board.
- Integrated soft-close hinge not included.
- Cabinet top features I-beam braces with a center support brace.

**Custom Modifications**

AUTHL AUTHR	CBO	CCO	CFNTD	CFP	CFRMO	CMAT	CND	DRT	DRWPWR	DRWSEC	DRWTK	EXBKL EXBKR
•	•	•										
EXL EXR	FB	FD	FFDL FFDR	FPEB	FTK	FTKAV FTKRV	ID	INVFRM	LTI	MIP	P	PTOWB
	•			•					•	•		
RD	RECTKALL RECTKBK	RECTKL RECTKR	RT	SCPDRW	TD	TOTSS TOTSSS	TVRAV TVRFV TVRVV	VTK	WLI			
	•	•						•	•			

**Construction Upgrades**

APC	ET	PE
•		•

**Door Options**

CG	DPSRR
	•

**BASE EASY REACH with ADJUSTABLE SHELVES**

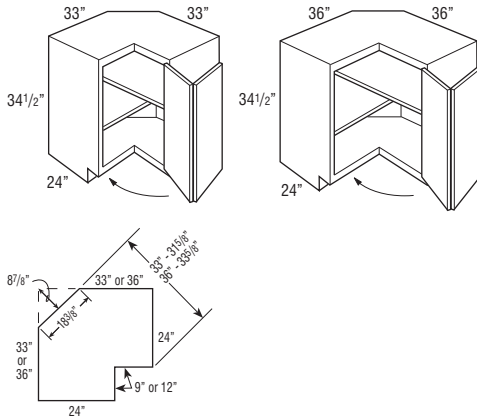

<b>BERAS33 L or R</b>	<b>24.0</b>
<b>BERAS36 L or R</b>	<b>25.9</b>

- BERAS33 L or R wall width is 33" x 33". BERAS36 L or R wall width is 36" x 36".
- Decorative hardware screws must be countersunk to prevent scratching of adjacent cabinets and face frame of BERAS.
- Adjustable crisscross shelves.
- Integrated soft-close hinge not included.

**Custom Modifications**

AUTHL AUTHR	CBO	CCO	CFNTD	CFP	CFRMO	CMAT	CND	DRT	DRWPWR	DRWSEC	DRWTK	EXBKL EXBKR
•	•	•										
EXL EXR	FB	FD	FFDL FFDR	FPEB	FTK	FTKAV FTKRV	ID	INVFRM	LTI	MIP	P	PTOWB
	•			•					•	•		
RD	RECTKALL RECTKBK	RECTKL RECTKR	RT	SCPDRW	TD	TOTSS TOTSSS	TVRAV TVRFV TVRVV	VTK	WLI			
	•	•						•	•			

**Construction Upgrades**

APC	ET	PE
•		•

**Door Options**

CG	DPSRR
	•

### ASYMMETRICAL BASE EASY REACH

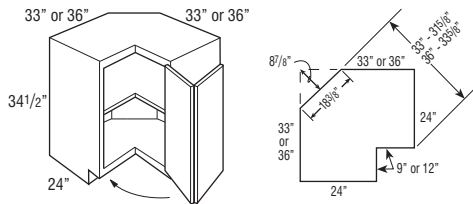

Model	Cubic Feet
<b>BER3336 L or R</b>	24.5
<b>BER3633 L or R</b>	24.5

- BER3336 L or R wall width is 33" x 36".
- BER3633 L or R wall width is 36" x 33".
- Legs at the front frames are 9" on 33" and 12" on 36" leg.
- Nomenclature for asymmetrical cabinets reads as follows:  
First set of numbers = left side of cabinet dimensions.  
Second set of numbers = right side of cabinet dimensions.
- Decorative hardware screws must be countersunk to prevent scratching of adjacent cabinets and face frame of BER.
- Fixed shelf is 1/2" thick laminated furniture board.
- Integrated soft-close hinge not included.
- Cabinet top features I-beam braces with a center support brace.

#### Custom Modifications

AUTHL	AUTHR	CBO	CCO	CFNTO	CFP	CFRMO	CMAT	CND	DRT	DRWPWR	DRWSEC	DRWTK	EXBKL	EXBKR	
•	•	•													
EXL	EXR	FB	FD	FFDL	FFDR	FPEB	FTK	FTKAV	FTKRV	ID	INVFRM	LTI	MIP	P	PTOWB
	•					•						•	•		
RD	RECTKALL	RECTKRBK	RECTKL	RECTKR	RT	SCPDRW	TD	TOTSS	TOTSSS	TVRAV	TVRFV	TVRVV	VTK	WLI	
	•	•											•	•	

#### Construction Upgrades

APC	ET	PE
•		•

#### Door Options

CG	DPSRR
	•

### ASYMMETRICAL BASE EASY REACH with ADJUSTABLE SHELVES

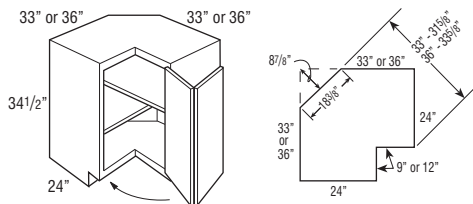

Model	Cubic Feet
<b>BERAS3336 L or R</b>	24.5
<b>BERAS3633 L or R</b>	24.5

- BERAS3336 L or R wall width is 33" x 36".
- BERAS3633 L or R wall width is 36" x 33".
- Legs at the front frames are 9" on 33" and 12" on 36" leg.
- Nomenclature for asymmetrical cabinets reads as follows:  
First set of numbers = left side of cabinet dimensions.  
Second set of numbers = right side of cabinet dimensions.
- Decorative hardware screws must be countersunk to prevent scratching of adjacent cabinets and face frame of BERAS.
- Adjustable crisscross shelves.
- Integrated soft-close hinge not included.

#### Custom Modifications

AUTHL	AUTHR	CBO	CCO	CFNTO	CFP	CFRMO	CMAT	CND	DRT	DRWPWR	DRWSEC	DRWTK	EXBKL	EXBKR	
•	•	•													
EXL	EXR	FB	FD	FFDL	FFDR	FPEB	FTK	FTKAV	FTKRV	ID	INVFRM	LTI	MIP	P	PTOWB
	•					•						•	•		
RD	RECTKALL	RECTKRBK	RECTKL	RECTKR	RT	SCPDRW	TD	TOTSS	TOTSSS	TVRAV	TVRFV	TVRVV	VTK	WLI	
	•	•											•	•	

#### Construction Upgrades

APC	ET	PE
•		•

#### Door Options

CG	DPSRR
	•

**SEGMENTED SUPER LAZY SUSAN**

LOGIX

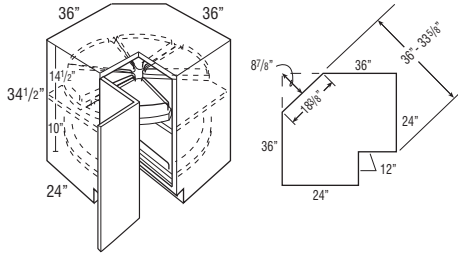

Due to fixed shelf mounting, shelves cannot be retrofitted.

Model	Cubic Feet
SSS36 L or R	30.5

- SSS36 L or R wall width is 36" x 36".
- Fixed shelf is 1/2" thick laminated furniture board.
- Rotating top shelf is segmented with Full Extension hardware.
- Rotating bottom shelf is continuous.
- Chrome rail surrounds both shelves. Chrome rail height is 2 13/16".
- Segmented shelves are plywood.
- Decorative hardware screws must be countersunk to prevent scratching adjacent cabinets and face frame of SSS.
- Integrated soft-close hinge not included.
- Cabinet top features I-beam braces with a center support brace.

**Custom Modifications**

AUTHL AUTHR	CBO	CCO	CFNT0	CFP	CFRMO	CMAT	CND	DRT	DRWPWR	DRWSEC	DRWTK	EXBKL EXBKR
	•	•										
EXL EXR	FB	FD	FFDL FFDR	FPEB	FTK	FTKAV FTKRV	ID	INVFRM	LTI	MIP	P	PTOWB
	•			•						•		
RD	RECTKALL RECTKBK	RECTKL RECTKR	RT	SCPDRW	TD	TOTSS TOTSSS	TVRAV TVRFV TVRVV	VTK	WLI			
	•	•						•	•			

**Construction Upgrades**

APC	ET	PE
•		•

**Door Options**

CG	DPSRR
	•

**SUPER LAZY SUSAN**

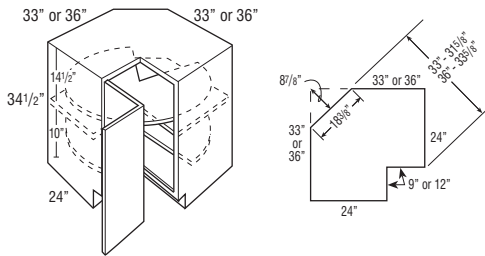

Due to fixed shelf mounting, shelves cannot be retrofitted.

SLS33 L or R	24.0
SLS36 L or R	30.5

- SLS33 L or R wall width is 33" x 33".
- SLS36 L or R wall width is 36" x 36".
- SLS33 - Susans are 28" diameter.
- SLS36 - Susans are 32" diameter.
- Features two plywood revolving shelves with a 1" plywood lip. Lower shelf is mounted to floor. Upper shelf is mounted to fixed shelf. Fixed shelf is 1/2" thick laminated furniture board.
- Decorative hardware screws must be countersunk to prevent scratching adjacent cabinets and face frame of SLS.
- Integrated soft-close hinge not included.
- Cabinet top features I-beam braces with a center support brace.

**Custom Modifications**

AUTHL AUTHR	CBO	CCO	CFNT0	CFP	CFRMO	CMAT	CND	DRT	DRWPWR	DRWSEC	DRWTK	EXBKL EXBKR
	•	•										
EXL EXR	FB	FD	FFDL FFDR	FPEB	FTK	FTKAV FTKRV	ID	INVFRM	LTI	MIP	P	PTOWB
	•			•						•	•	
RD	RECTKALL RECTKBK	RECTKL RECTKR	RT	SCPDRW	TD	TOTSS TOTSSS	TVRAV TVRFV TVRVV	VTK	WLI			
	•	•						•	•			

**Construction Upgrades**

APC	ET	PE
•		•

**Door Options**

CG	DPSRR
	•



## SOLID-WOOD SUPER LAZY SUSAN

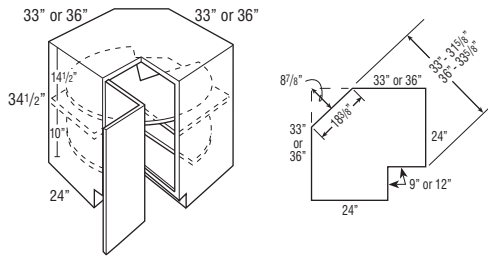

Due to fixed shelf mounting, shelves cannot be retrofitted.

Model	Cubic Feet
<b>SLSW33 L or R</b>	<b>24.0</b>
<b>SLSW36 L or R</b>	<b>30.5</b>

- SLSW33 L or R wall width is 33" x 33".
- SLSW36 L or R wall width is 36" x 36".
- SLSW33 L or R - Susans are 28" diameter.
- SLSW36 L or R - Susans are 32" diameter.
- Features two hardwood revolving shelves with a 3/16" lip. Lower shelf is mounted to floor. Upper shelf is mounted to fixed shelf. Fixed shelf is 1/2" thick laminated furniture board.
- Decorative hardware screws must be countersunk to prevent scratching adjacent cabinets and face frame of SLS.
- Integrated soft-close hinge not included.
- Cabinet top features I-beam braces with a center support brace.

### Custom Modifications

AUTHL AUTHR	CBO	CCO	CFNTO	CFP	CFRMO	CMAT	CND	DRT	DRWPPWR	DRWSEC	DRWTK	EXBKL EXBKR
	•	•										
EXL EXR	FB	FD	FFDL FFDR	FPEB	FTK	FTKAV FTKRV	ID	INVFRM	LTJ	MIP	P	PTOWB
	•			•					•	•		
RD	RECTKALL RECTKBK	RECTKL RECTKR	RT	SCPORW	TD	TOTSS TOTSSS	TVRAV TVRFV TVRVV	VTK	WLI			
	•	•						•	•			

### Construction Upgrades

APC	ET	PE
•		•

### Door Options

CG	DPSRR
	•

## SUPER LAZY SUSAN with CHROME RAIL

L G I X

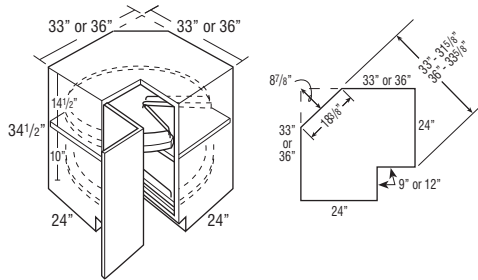

Due to fixed shelf mounting, shelves cannot be retrofitted.

<b>SLSR33 L or R</b>	<b>30.5</b>
<b>SLSR36 L or R</b>	<b>30.5</b>

- SLSR33 L or R wall width is 33" x 33". SLSR36 L or R wall width is 36" x 36".
- SLSR33 - Susans are 28" diameter. SLSR36 - Susans are 32" diameter.
- Features two plywood revolving shelves with a 1" plywood lip. Lower shelf is mounted to floor. Upper shelf is mounted to fixed shelf. Fixed shelf is 1/2" thick laminated furniture board.
- Chrome rail surrounds both shelves. Chrome rail height is 2 13/16".
- Decorative hardware screws must be countersunk to prevent scratching adjacent cabinets and face frame of SLSR.
- Integrated soft-close hinge not included.
- Cabinet top features I-beam braces with a center support brace.

### Custom Modifications

AUTHL AUTHR	CBO	CCO	CFNTO	CFP	CFRMO	CMAT	CND	DRT	DRWPPWR	DRWSEC	DRWTK	EXBKL EXBKR
	•	•										
EXL EXR	FB	FD	FFDL FFDR	FPEB	FTK	FTKAV FTKRV	ID	INVFRM	LTJ	MIP	P	PTOWB
	•			•					•	•		
RD	RECTKALL RECTKBK	RECTKL RECTKR	RT	SCPORW	TD	TOTSS TOTSSS	TVRAV TVRFV TVRVV	VTK	WLI			
	•	•						•	•			

### Construction Upgrades

APC	ET	PE
•		•

### Door Options

CG	DPSRR
	•

**ASYMMETRICAL SUPER LAZY SUSAN**

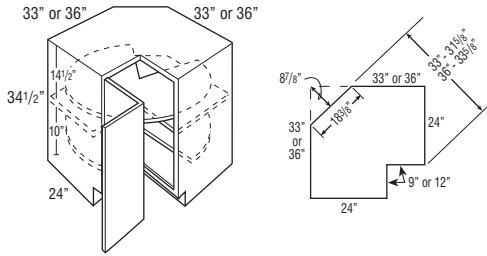

Due to fixed shelf mounting, shelves cannot be retrofitted.

Model	Cubic Feet
<b>SLS3336 L or R</b>	29.1
<b>SLS3633 L or R</b>	29.1

- SLS3336 L or R wall width is 33" x 36".
- SLS3633 L or R wall width is 36" x 33".
- All Asymmetrical Super Susan shelves are 28" diameter.
- Features two plywood revolving shelves with a 3/16" plywood lip. Lower shelf is mounted to floor. Upper shelf is mounted to fixed shelf. Fixed shelf is 1/2" thick laminated furniture board.
- Nomenclature for asymmetrical cabinets reads as follows:  
First set of numbers = left side of cabinet dimensions.  
Second set of numbers = right side of cabinet dimensions.
- Decorative hardware screws must be countersunk to prevent scratching adjacent cabinets and face frame of SLS.
- Integrated soft-close hinge not included.
- Cabinet top features I-beam braces with a center support brace.

**Custom Modifications**

AUTHL AUTHR	CBO	CCO	CFNTO	CFP	CFRMO	CMAT	CND	DRT	DRWPWR	DRWSEC	DRWTK	EXBKL EXBKR
	•	•										
EXL EXR	FB	FD	FFDL FFDR	FPEB	FTK	FTKAV FTKRV	ID	INVFRM	LTI	MIP	P	PTOWB
	•			•					•	•		
RD	RECTKALL RECTKBK	RECTKL RECTKR	RT	SCPDRW	TD	TOTSS TOTSSS	TVRAV TVRFV TVRVV	VTK	WLI			
	•	•						•	•			

**Construction Upgrades**

APC	ET	PE
•		•

**Door Options**

CG	DPSRR
	•

**ASYMMETRICAL SOLID-WOOD SUPER LAZY SUSAN**

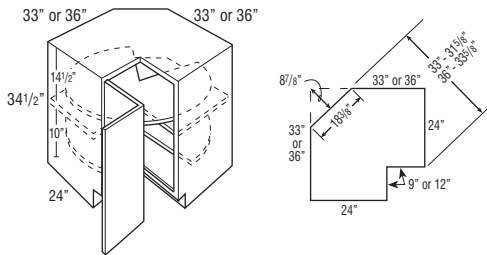

Due to fixed shelf mounting, shelves cannot be retrofitted.

<b>SLSW3336 L or R</b>	29.1
<b>SLSW3633 L or R</b>	29.1

- SLSW3336 L or R wall width is 33" x 36".
- SLSW3633 L or R wall widths is 36" x 33".
- All Asymmetrical Super Susan shelves are 28" diameter.
- Features two hardwood revolving shelves with a 1" lip. Lower shelf is mounted to floor. Upper shelf is mounted to fixed shelf. Fixed shelf is 1/2" thick laminated furniture board.
- Nomenclature for asymmetrical cabinets reads as follows:  
First set of numbers = left side of cabinet dimensions.  
Second set of numbers = right side of cabinet dimensions.
- Decorative hardware screws must be countersunk to prevent scratching adjacent cabinets and face frame of SLS.
- Integrated soft-close hinge not included.
- Cabinet top features I-beam braces with a center support brace.

**Custom Modifications**

AUTHL AUTHR	CBO	CCO	CFNTO	CFP	CFRMO	CMAT	CND	DRT	DRWPWR	DRWSEC	DRWTK	EXBKL EXBKR
	•	•										
EXL EXR	FB	FD	FFDL FFDR	FPEB	FTK	FTKAV FTKRV	ID	INVFRM	LTI	MIP	P	PTOWB
	•			•					•	•		
RD	RECTKALL RECTKBK	RECTKL RECTKR	RT	SCPDRW	TD	TOTSS TOTSSS	TVRAV TVRFV TVRVV	VTK	WLI			
	•	•						•	•			

**Construction Upgrades**

APC	ET	PE
•		•

**Door Options**

CG	DPSRR
	•

## ASYMMETRICAL SUPER LAZY SUSAN with CHROME RAIL

L O G I X

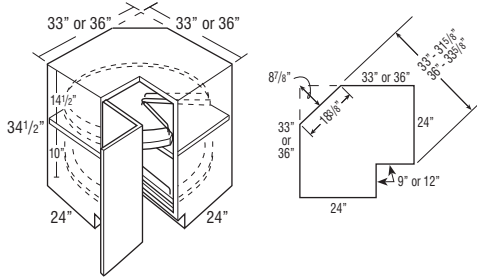

Model	Cubic Feet
SLSCR3336 L or R	30.5
SLSCR3633 L or R	30.5

- SLSCR3336 L or R wall width is 33" x 36".
- SLSCR3633 L or R wall width is 36" x 33".
- All Asymmetrical Super Susan shelves are 28" diameter.
- Features two plywood revolving shelves with a 1" plywood lip. Lower shelf is mounted to floor. Upper shelf is mounted to fixed shelf. Fixed shelf is 1/2" thick laminated furniture board.
- Chrome rail surrounds both shelves. Chrome rail height is 2 13/16".
- Nomenclature for asymmetrical cabinets reads as follows:  
First set of numbers = left side of cabinet dimensions.  
Second set of numbers = right side of cabinet dimensions.
- Decorative hardware screws must be countersunk to prevent scratching adjacent cabinets and face frame of SLS.
- Integrated soft-close hinge not included.
- Cabinet top features I-beam braces with a center support brace.

### Custom Modifications

AUTHL AUTHR	CBO	CCO	CFNTO	CFP	CFRMO	CMAT	CND	DRT	DRWPWR	DRWSEC	DRWTK	EXBKL EXBKR
	•	•										
EXL EXR	FB	FD	FFDL FFDR	FPEB	FTK	FTKAV FTKRV	ID	INVFRM	ITI	MIP	P	PTOWB
	•			•					•	•		
RD	RECTKALL RECTKBK	RECTKL RECTKR	RT	SCPDRW	TD	TOTSS TOTSSS	TVRAV TVRFV TVRVV	VTK	WLI			
	•	•						•	•			

### Construction Upgrades

APC	ET	PE
•		•

### Door Options

CG	DPSRR
	•

## BASE ROTATING DEEP BIN

L O G I X

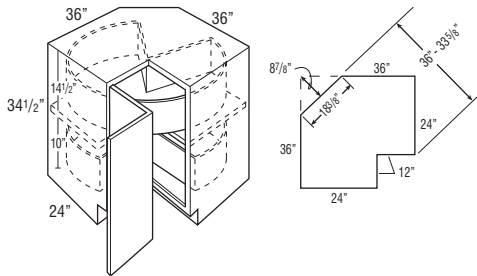

Due to fixed shelf mounting, shelves cannot be retrofitted.

BRDB36 L or R	30.5
---------------	------

- BRDB36 wall width is 36" x 36".
- BRDB36 shelves are 30" diameter. Bins are 6" deep.
- Not available in asymmetrical applications.
- Inside bottom of lower deep susan to the fixed shelf is 10" high.
- Inside bottom of upper deep susan to the bottom of face frame cross rail is 14 1/8" high.
- Decorative hardware screws must be countersunk to prevent scratching of adjacent cabinets and face frame of BRDB.
- Integrated soft-close hinge not included.
- Cabinet top features I-beam braces with a center support brace.

### Custom Modifications

AUTHL AUTHR	CBO	CCO	CFNTO	CFP	CFRMO	CMAT	CND	DRT	DRWPWR	DRWSEC	DRWTK	EXBKL EXBKR
	•	•										
EXL EXR	FB	FD	FFDL FFDR	FPEB	FTK	FTKAV FTKRV	ID	INVFRM	ITI	MIP	P	PTOWB
	•			•					•	•		
RD	RECTKALL RECTKBK	RECTKL RECTKR	RT	SCPDRW	TD	TOTSS TOTSSS	TVRAV TVRFV TVRVV	VTK	WLI			
	•	•						•	•			

### Construction Upgrades

APC	ET	PE
•		•

### Door Options

CG	DPSRR
	•

**LAZY SUSAN PULL-OUT**

L O G I X

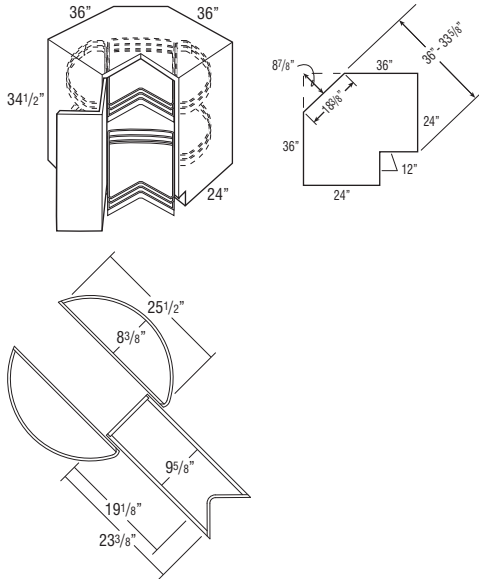

Model	Cubic Feet
LSP36 L or R	30.5

- LSP36 L or R wall width is 36" x 36".
- Features four half-moon bins (8 3/8" x 25 1/2" each) with plywood shelves and chrome rail sides.
- Center pull-outs have Smart Stop guides and operate independently. Entire unit rotates when center pull-outs are in closed position.
- Decorative hardware screws must be countersunk to prevent scratching adjacent cabinets and face frame of LSP.
- Integrated soft-close hinge not included.

**Custom Modifications**

AUTHL AUTHR	CBO	CCO	CFNT0	CFP	CFRMO	CMAT	CND	DRT	DRWPWR	DRWSEC	DRWTK	EXBKL EXBKR
	•	•										•
EXL EXR	FB	FD	FFDL FFDR	FPEB	FTK	FTKAV FTKFV	ID	INVFRM	LTI	MIP	P	PTOWB
	•			•						•		
RD	RECTKALL RECTKBK	RECTKL RECTKR	RT	SCPDRW	TD	TOTSS TOTSSS	TVRAV TVRFV TVRVV	VTK	WLI			
	•	•						•	•			

**Construction Upgrades**

APC	ET	PE
•		•

**Door Options**

CG	DPSRR
	•

**THREE DRAWER CORNER CABINET**

Model	Cubic Feet
3CDB36	15.0

- Must be installed between 2 cabinets.
- Allow for proper clearance of drawer head when specifying corner drawer cabinets next to appliances.
- Will have less than 3/4" overlay side reveal for clearance purposes.
- Cabinet sides will always be Natural Maple laminate. If PE or APC is specified, cabinet sides will be unfinished.
- Exterior height of bottom 2 drawer boxes is 7 3/8".

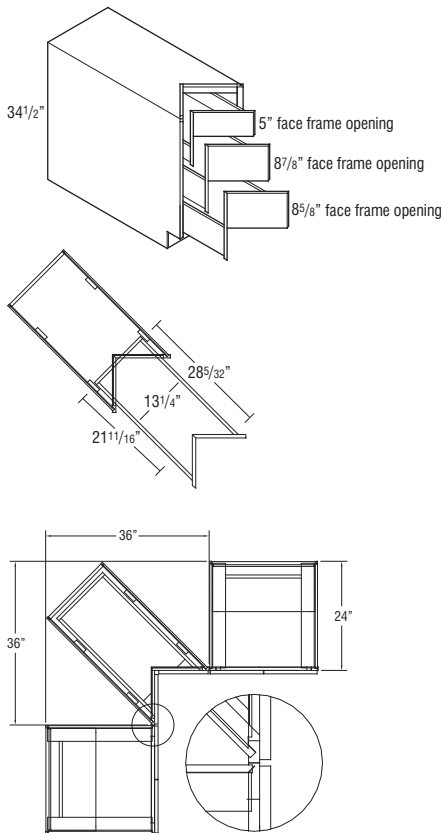

A Dimension	B Dimension
24"	0"
25"	3/4"
26"	1 3/4"
27"	2 3/4"
28"	3 3/4"
29"	4 3/4"
30"	5 3/4"

**Custom Modifications**

AUTHL AUTHR	CBO	CCO	CFNT0	CFP	CFRMO	CMAT	CND	DRT	DRWPWR	DRWSEC	DRWTK	EXBKL EXBKR
	•	•										
EXL EXR	FB	FD	FFDL FFDR	FPEB	FTK	FTKAV FTKFV	ID	INVFRM	LTI	MIP	P	PTOWB
										•		
RD	RECTKALL RECTKBK	RECTKL RECTKR	RT	SCPDRW	TD	TOTSS TOTSSS	TVRAV TVRFV TVRVV	VTK	WLI			
								•				

**Construction Upgrades**

APC	ET	PE
•		•

**Door Options**

CG	DPSRR
	•

**BASE TRANSITION CABINET**

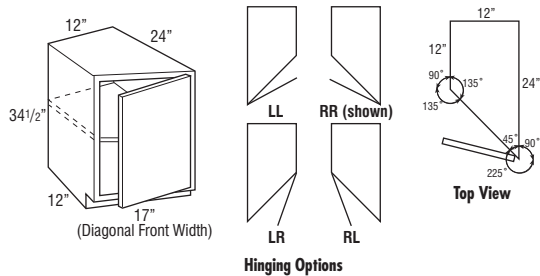

Model	Cubic Feet
BTC12LL	14.4
BTC12RL	14.4
BTC12LR	14.4
BTC12RR	14.4

- One adjustable shelf.
- Cabinets constructed with top.
- Specify door hinging. RR shown.
- Depth can be reduced to a minimum of 18".
- RECTKBK, RECTKL and RECTKR cannot be ordered when RD is specified. RECTKL and RECTKR cannot be specified on the same cabinet.
- Full overlay styles use the same width doors as partial overlay styles (14 1/2" wide) with a partial overlay hinge (38NPOHINGE) to allow for proper door clearance with adjacent cabinets.

**Custom Modifications**

AUTHL AUTHR	CBO	CCO	CFNT0	CFP	CFRMO	CMAT	CND	DRT	DRWPWR	DRWSEC	DRWTK	EXBKL EXBKR
•*	•	•	•		•							
EXL EXR	FB	FD	FFDL FFDR	FPEB	FTK	FTKAV FTKFV	ID	INVFRM	LTI	MIP	P	PTOWB
	•		•*	•*	•				•	•		
RD	RECTKALL RECTKBK	RECTKL RECTKR	RT	SCPDRW	TD	TOTSS TOTSSS	TVRAV TVRFV TVRVV	VTK	WLI			
•	•+	•						•	•			

\*Available only on 12" deep side of cabinet \*RECTKALL not available

**Construction Upgrades**

APC	ET	PE
•		•

**Door Options**

CG	DPSRR
•	•

**135° CORNER OUTSIDE BASE**

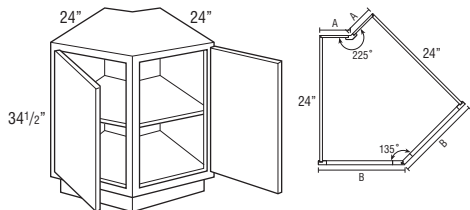

Model	A Dimension	B Dimension
BFH6COA	6"	15 15/16"
BFH9COA	9"	18 15/16"
BFH12COA	12"	21 15/16"

A indicates back width of cabinet and wall space.  
B indicates face frame width.

BFH6COA	21.8
BFH9COA	26.6
BFH12COA	31.6

- Doors are hinged on outside of frame.
- Adjustable shelves cannot be removed from the cabinet.

**Custom Modifications**

AUTHL AUTHR	CBO	CCO	CFNT0	CFP	CFRMO	CMAT	CND	DRT	DRWPWR	DRWSEC	DRWTK	EXBKL EXBKR
•	•	•										
EXL EXR	FB	FD	FFDL FFDR	FPEB	FTK	FTKAV FTKFV	ID	INVFRM	LTI	MIP	P	PTOWB
	•			•					•	•		
RD	RECTKALL RECTKBK	RECTKL RECTKR	RT	SCPDRW	TD	TOTSS TOTSSS	TVRAV TVRFV TVRVV	VTK	WLI			
								•	•			

**Construction Upgrades**

APC	ET	PE
•		•

**Door Options**

CG	DPSRR
	•

**135° CORNER INSIDE BASE**

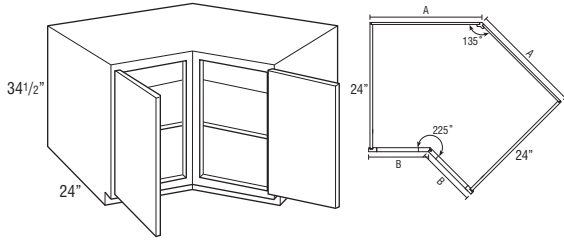

Model	A Dimension	B Dimension
BFH21CIA	21"	11 3/32"
BFH24CIA	24"	14 3/32"
BFH27CIA	27"	17 3/32"

A indicates back width of cabinet and wall space.  
B indicates face frame width.

Model	Cubic Feet
BFH21CIA	29.8
BFH24CIA	34.9
BFH27CIA	40.4

- Doors are hinged on outside of frame.
- Adjustable shelves cannot be removed from the cabinet.

**Custom Modifications**

AUTHL AUTHR	CBO	CCO	CFNT0	CFP	CFRMO	CMAT	CND	DRT	DRWPWR	DRWSEC	DRWTK	EXBKL EXBKR
•	•	•										
EXL EXR	FB	FD	FFDL FFDR	FPEB	FTK	FTKAV FTKRV	ID	INVFRM	LTI	MIP	P	PTOWB
	•			•					•*	•		
RD	RECTKALL RECTKBK	RECTKL RECTKR	RT	SCPDWR	TD	TOTSS TOTSSS	TAVR TVRFV TVRVV	VTK	WLI			
								•	•			

\*Not available on 21" and 24" wide

**Construction Upgrades**

APC	ET	PE
•		•

**Door Options**

CG	DPSRR
	•

**BASE END CABINET**

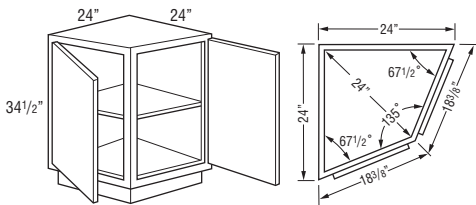

BEC24	14.3
-------	------

- Wall width is 24" x 24".
- 24" W x 24" D x 34 1/2" H.
- 24" from outside corner point to frame face.
- Cabinets constructed with top.
- One adjustable shelf.
- Cabinet may be installed against either end of a run.

**Custom Modifications**

AUTHL AUTHR	CBO	CCO	CFNT0	CFP	CFRMO	CMAT	CND	DRT	DRWPWR	DRWSEC	DRWTK	EXBKL EXBKR
	•	•										
EXL EXR	FB	FD	FFDL FFDR	FPEB	FTK	FTKAV FTKRV	ID	INVFRM	LTI	MIP	P	PTOWB
					•				•	•		
RD	RECTKALL RECTKBK	RECTKL RECTKR	RT	SCPDWR	TD	TOTSS TOTSSS	TAVR TVRFV TVRVV	VTK	WLI			
								•	•			

**Construction Upgrades**

APC	ET	PE
•		

**Door Options**

CG	DPSRR
•	•

## TWO DRAWER BASE with FILE DRAWER

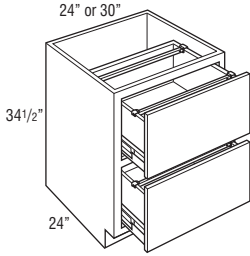

Model	Cubic Feet
<b>2DB24FD</b>	14.3
<b>2DB30FD</b>	17.6

- Includes Filing System Hardware Kit, which accommodates letter and legal filing.
- Drawers utilize 125 lb. full extension progressive side-mount guide, does not feature soft-close guide.
- Depth can be reduced to a minimum of 21".
- Exterior drawer box height is 10".

### Custom Modifications

AUTHL AUTHR	CBO	CCO	CFNTO	CFP	CFRMO	CMAT	CND	DRT	DRWPWR	DRWSEC	DRWTK	EXBKL EXBKR
•	•	•			•							•
EXL EXR	FB	FD	FFDL FFDR	FPEB	FTK	FTKAV FTKRV	ID	INVFRM	LTI	MIP	P	PTOWB
•	•			•	•	•					•	
RD	RECTKALL RECTKBK	RECTKL RECTKR	RT	SCPDRW	TD	TOTSS TOTSSS	TVRAV TVRFV TVRVV	VTK	WLI			
•	•	•						•				

### Construction Upgrades

APC	ET	PE
•		•

### Door Options

CG	DPSRR

## TWO DRAWER BASE

18", 21", 24", 27", 30", 33", 36", 42", or 48"

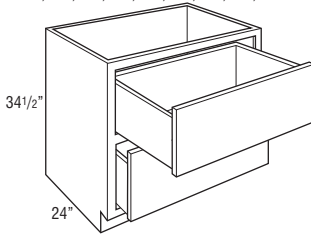

<b>2DB18</b>	11.1
<b>2DB21</b>	12.8
<b>2DB24</b>	14.4
<b>2DB27</b>	15.6
<b>2DB30</b>	17.7
<b>2DB33</b>	18.8
<b>2DB36</b>	21.1
<b>2DB42</b>	23.4
<b>2DB48</b>	26.6

- Exterior drawer box height is 10".
- When SCPDRW is selected, the top drawer will utilize a 6 3/8" high drawer box instead of the current 10" high drawer box, creating a clearance of 6 5/8" for the cooktop.
- When 2DB48 is ordered in Liberty with DFF5PC, drawer fronts will have a vertical cross rail with two center panels.

### Custom Modifications

AUTHL AUTHR	CBO	CCO	CFNTO	CFP	CFRMO	CMAT	CND	DRT	DRWPWR	DRWSEC	DRWTK	EXBKL EXBKR
•	•	•			•						•*	•
EXL EXR	FB	FD	FFDL FFDR	FPEB	FTK	FTKAV FTKRV	ID	INVFRM	LTI	MIP	P	PTOWB
•	•			•	•	•					•	
RD	RECTKALL RECTKBK	RECTKL RECTKR	RT	SCPDRW	TD	TOTSS TOTSSS	TVRAV TVRFV TVRVV	VTK	WLI			
•*	•	•		•				•				

\*Not available on 42" and 48" wide \*Depth can be reduced to a minimum of 21" on 42" and 48" wide cabinets

### Construction Upgrades

APC	ET	PE
•		•

### Door Options

CG	DPSRR

**TWO DRAWER BASE with PEGGED DISH ORGANIZER**

LOGIX

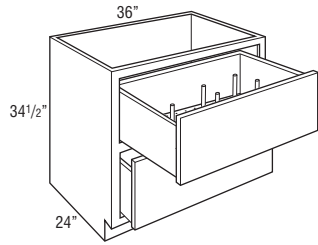

Model	Cubic Feet
<b>2DB36PDO</b>	21.1

- Includes 8 wooden posts.
- Includes 19/32" thick removable pegged board in top drawer.
- Exterior drawer box height is 10".
- Additional posts available as an accessory. See page 422.
- Posts and pegged board available as accessories for field installation. See page 422.
- When SCPDRW is selected, the top drawer will utilize a 6 3/8" high drawer box instead of the current 10" high drawer box, creating a clearance of 6 5/8" for the cooktop.

**Custom Modifications**

AUTHL AUTHR	CBO	CCO	CFNTD	CFP	CFRMO	CMAT	CND	DRT	DRWPWR	DRWSEC	DRWTK	EXBKL EXBKR
•	•	•			•						•	•
EXL EXR	FB	FD	FFDL FFDR	FPEB	FTK	FTKAV FTKRV	ID	INVFRM	LTI	MIP	P	PTOWB
•	•			•	•	•				•		
RD	RECTKALL RECTKBK	RECTKL RECTKR	RT	SCPDRW	TD	TOTSS TOTSSS	TVRAV TVRFV TVRVV	VTK	WLI			
	•	•		•				•				

**Construction Upgrades**

APC	ET	PE
•		•

**Door Options**

CG	DPSRR

**TWO DRAWER BASE with ROLL TRAY**

LOGIX

18", 21", 24", 27", 30", 33", or 36"

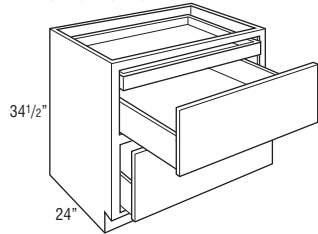

<b>2DB18RT</b>	11.1
<b>2DB21RT</b>	12.8
<b>2DB24RT</b>	14.4
<b>2DB27RT</b>	16.1
<b>2DB30RT</b>	17.7
<b>2DB33RT</b>	19.6
<b>2DB36RT</b>	21.1

- Includes a roll tray above the top drawer box.
- Exterior height for bottom drawer box is 6 3/8".

**Custom Modifications**

AUTHL AUTHR	CBO	CCO	CFNTD	CFP	CFRMO	CMAT	CND	DRT	DRWPWR	DRWSEC	DRWTK	EXBKL EXBKR
•	•	•			•						•	•
EXL EXR	FB	FD	FFDL FFDR	FPEB	FTK	FTKAV FTKRV	ID	INVFRM	LTI	MIP	P	PTOWB
•	•			•	•	•				•		
RD	RECTKALL RECTKBK	RECTKL RECTKR	RT	SCPDRW	TD	TOTSS TOTSSS	TVRAV TVRFV TVRVV	VTK	WLI			
•	•	•						•				

**Construction Upgrades**

APC	ET	PE
•		•

**Door Options**

CG	DPSRR



**TWO DRAWER BASE with ROLL TRAY and PEGGED DISH ORGANIZER**

L O G I X

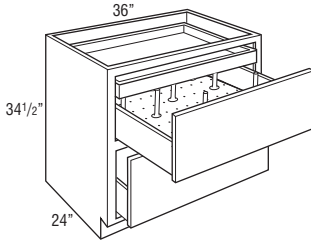

Model	Cubic Feet
<b>2DB36RTPDO</b>	21.1

- Includes a roll tray above the top drawer box.
- Includes 8 wooden posts.
- Includes 19/32" thick removable pegged board in top drawer.
- Additional posts available as an accessory. See page 422.
- Posts and pegged board available as accessories for field installation. See page 422.

**Custom Modifications**

AUTHL AUTHR	CBO	CCO	CFNT0	CFP	CFRMO	CMAT	CND	DRT	DRWPWR	DRWSEC	DRWTK	EXBKL EXBKR
•	•	•			•						•	•
EXL EXR	FB	FD	FFDL FFDR	FPEB	FTK	FTKAV FTKRV	ID	INVFRM	LTl	MIP	P	PTOWB
•	•			•	•	•				•		
RD	RECTKALL RECTKBK	RECTKL RECTKR	RT	SCPDRW	TD	TOTSS TOTSSS	TVRAV TVRFV TVRVV	VTK	WLI			
•	•	•						•				

**Construction Upgrades**

APC	ET	PE
•		•

**Door Options**

CG	DPSRR

**TWO DRAWER BASE, DROP-IN RANGE**

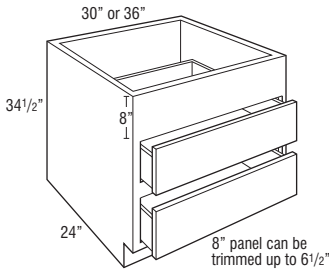

<b>2DB30DR</b>	17.7
<b>2DB36DR</b>	21.1

- Exterior height of drawer boxes is 6 3/8"

**Custom Modifications**

AUTHL AUTHR	CBO	CCO	CFNT0	CFP	CFRMO	CMAT	CND	DRT	DRWPWR	DRWSEC	DRWTK	EXBKL EXBKR
•	•	•	•		•						•	•
EXL EXR	FB	FD	FFDL FFDR	FPEB	FTK	FTKAV FTKRV	ID	INVFRM	LTl	MIP	P	PTOWB
•	•			•	•	•				•		
RD	RECTKALL RECTKBK	RECTKL RECTKR	RT	SCPDRW	TD	TOTSS TOTSSS	TVRAV TVRFV TVRVV	VTK	WLI			
•	•	•						•				

**Construction Upgrades**

APC	ET	PE
•		•

**Door Options**

CG	DPSRR

**TWO DRAWER BASE, DROP-IN RANGE and WARMING DRAWER**

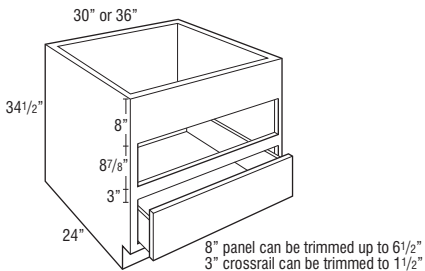

<b>2DB30DRWD</b>	17.7
<b>2DB36DRWD</b>	21.1

- Exterior height of bottom drawer box is 6 3/8"
- For built-in appliance support, OCINSTALKIT is included in 24" deep warming drawer cabinets (see page 422 for details), but will not be included when depth is modified.

**Custom Modifications**

AUTHL AUTHR	CBO	CCO	CFNT0	CFP	CFRMO	CMAT	CND	DRT	DRWPWR	DRWSEC	DRWTK	EXBKL EXBKR
•	•	•	•		•						•	•
EXL EXR	FB	FD	FFDL FFDR	FPEB	FTK	FTKAV FTKRV	ID	INVFRM	LTl	MIP	P	PTOWB
•	•			•	•	•				•		
RD	RECTKALL RECTKBK	RECTKL RECTKR	RT	SCPDRW	TD	TOTSS TOTSSS	TVRAV TVRFV TVRVV	VTK	WLI			
•	•	•						•				

**Construction Upgrades**

APC	ET	PE
•		•

**Door Options**

CG	DPSRR

**THREE DRAWER BASE**

12", 15", 18", or 21"

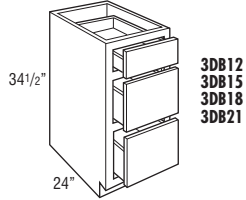

24", 27", 30", 33", or 36"

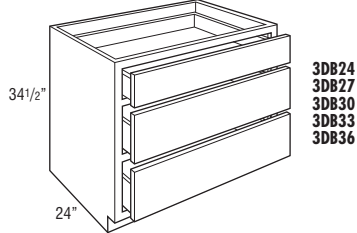

Model	Cubic Feet
<b>3DB12</b>	7.8
<b>3DB15</b>	9.4
<b>3DB18</b>	11.1
<b>3DB21</b>	12.8
<b>3DB24</b>	14.4
<b>3DB27</b>	16.1
<b>3DB30</b>	17.7
<b>3DB33</b>	19.6
<b>3DB36</b>	21.1

• Exterior height of bottom 2 drawer boxes is 6 3/8".

**Custom Modifications**

AUTHL AUTHR	CBO	CCO	CFNTO	CFP	CFRMO	CMAT	CND	DRT	DRWPWR	DRWSEC	DRWTK	EXBKL EXBKR
•	•	•		•	•				•*	•*	•*	•
EXL EXR	FB	FD	FFDL FFDR	FPEB	FTK	FTKAV FTKFV	ID	INVFRM	LTI	MIP	P	PTOWB
•	•			•	•	•▲				•		
RD	RECTKALL RECTKBK	RECTKL RECTKR	RT	SCPDRW	TD	TOTSS TOTSSS	TVRAV TVRFV TVRVV	VTK	WLI			
•	•	•		•				•				

\*Not available on 12" and 15" wide    \*Available only on 18", 21", and 24" wide    ▲Not available on 12" wide

**Construction Upgrades**

APC	ET	PE
•		•

**Door Options**

CG	DPSRR

**THREE DRAWER BASE BUFFET**

30", 33", or 36"

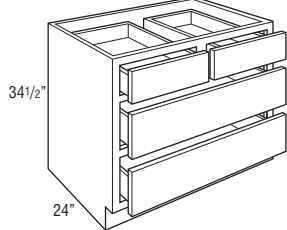

<b>3DBB30</b>	17.7
<b>3DBB33</b>	19.6
<b>3DBB36</b>	21.1

• Exterior height of bottom 2 drawer boxes is 6 3/8".

**Custom Modifications**

AUTHL AUTHR	CBO	CCO	CFNTO	CFP	CFRMO	CMAT	CND	DRT	DRWPWR	DRWSEC	DRWTK	EXBKL EXBKR
•	•	•		•	•				•*	•*	•	•
EXL EXR	FB	FD	FFDL FFDR	FPEB	FTK	FTKAV FTKFV	ID	INVFRM	LTI	MIP	P	PTOWB
•	•			•	•	•				•		
RD	RECTKALL RECTKBK	RECTKL RECTKR	RT	SCPDRW	TD	TOTSS TOTSSS	TVRAV TVRFV TVRVV	VTK	WLI			
•	•	•		•				•				

\*Not available on 30" and 33" wide

**Construction Upgrades**

APC	ET	PE
•		•

**Door Options**

CG	DPSRR

**THREE DRAWER BASE with WOOD TIERED CUTLERY DIVIDER DRAWER**

LOGIX

Model	Cubic Feet
3DB15WTCD	9.4
3DB18WTCD	11.1
3DB21WTCD	12.8
3DB24WTCD	14.4

15", 18", 21", or 24"

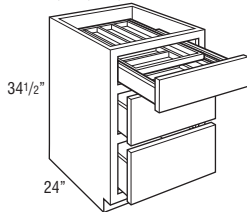

- Exterior height for lower drawer boxes is 6 3/8".
- Exterior WTCDDrawer box height is 3 3/4", interior height of top and bottom tier is 1 3/8".
- Wood Tiered Cutlery Divider Drawer is also available as an accessory. See page 418.

**Custom Modifications**

AUTHL AUTHR	CBO	CCO	CFNTO	CFP	CFRMO	CMAT	CND	DRT	DRWPWR	DRWSEC	DRWTK	EXBKL EXBKR
•	•	•			•						•*	•
EXL EXR	FB	FD	FFDL FFDR	FPEB	FTK	FTKAV FTKEV	ID	INVERM	LTl	MIP	P	PTOWB
•	•			•	•	•				•		
RD	RECTKALL RECTKBK	RECTKL RECTKR	RT	SCPDRW	TD	TOTSS TOTSSS	TVRAV TVRFV TVRVV	VTK	WLI			
	•	•						•				

\*Not available on 15" wide

**Construction Upgrades**

APC	ET	PE
•		•

**Door Options**

CG	DPSRR

**THREE DRAWER BASE with WOOD TIERED K-CUP\* DRAWER**

LOGIX

3DB18KUP	11.1
----------	------

18"

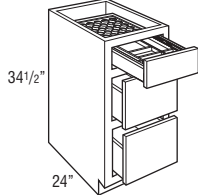

- Holds 40 K-Cups.
- Exterior height for lower drawer boxes is 6 3/8".
- Exterior Wood Tiered K-Cup drawer box height is 3 3/4", interior height of top tier is 1 5/8", and interior height of bottom tier is 1 3/8".
- The Wood Tiered K-Cup Drawer is compatible with K-Cup pods only.
- Wood Tiered K-Cup Drawer is also available as an accessory. See page 419.

\*K-Cup is a registered trademark of Keurig Green Mountain, Inc.

**Custom Modifications**

AUTHL AUTHR	CBO	CCO	CFNTO	CFP	CFRMO	CMAT	CND	DRT	DRWPWR	DRWSEC	DRWTK	EXBKL EXBKR
•	•	•			•						•	•
EXL EXR	FB	FD	FFDL FFDR	FPEB	FTK	FTKAV FTKEV	ID	INVERM	LTl	MIP	P	PTOWB
•	•			•	•	•				•		
RD	RECTKALL RECTKBK	RECTKL RECTKR	RT	SCPDRW	TD	TOTSS TOTSSS	TVRAV TVRFV TVRVV	VTK	WLI			
	•	•						•				

**Construction Upgrades**

APC	ET	PE
•		•

**Door Options**

CG	DPSRR

**THREE DRAWER BASE, WARMING DRAWER**

24", 27", 30", or 36"

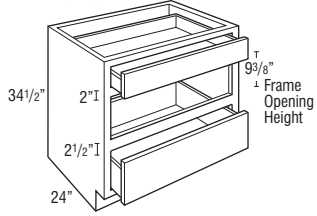

Model	Opening Width	Maximum Width	Opening Height	Maximum Height
3DB24WD	21"	22 1/2"	9 3/8"	11 3/8"
3DB27WD	24"	25 1/2"	9 3/8"	11 3/8"
3DB30WD	27"	28 1/2"	9 3/8"	11 3/8"
3DB36WD	33"	34 1/2"	9 3/8"	11 3/8"

Model	Cubic Feet
<b>3DB24WD</b>	14.4
<b>3DB27WD</b>	16.1
<b>3DB30WD</b>	17.7
<b>3DB36WD</b>	21.1

- Exterior height of bottom drawer box is 6 3/8".
- For built-in appliance support, OCINSTALLKIT is included in 24" deep warming drawer cabinets (see page 422 for details), but will not be included when depth is modified.

**Custom Modifications**

AUTHL AUTHR	CBO	CCO	CFNTO	CFP	CFRMO	CMAT	CND	DRT	DRWPWR	DRWSEC	DRWTK	EXBKL EXBKR
•	•	•		•	•				•		•	•
EXL EXR	FB	FD	FFDL FFDR	FPEB	FTK	FTKAV FTKRV	ID	INVFRM	LTI	MIP	P	PTOWB
•	•			•	•	•				•		
RD	RECTKALL RECTKBK	RECTKL RECTKR	RT	SCPDRW	TD	TOTSS TOTSSS	TVRV TVRFV TVRVV	VTK	WLI			
•	•	•		•				•				

**Construction Upgrades**

APC	ET	PE
•		•

**Door Options**

CG	DPSRR

**THREE DRAWER BASE with DEEP DRAWER**

LOGIX

24", 30", 33", or 36"

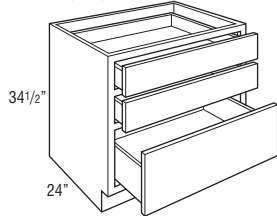

<b>3DBDD24</b>	14.4
<b>3DBDD30</b>	17.7
<b>3DBDD33</b>	17.6
<b>3DBDD36</b>	20.9

- Exterior height of bottom drawer box is 10".

**Custom Modifications**

AUTHL AUTHR	CBO	CCO	CFNTO	CFP	CFRMO	CMAT	CND	DRT	DRWPWR	DRWSEC	DRWTK	EXBKL EXBKR
•	•	•		•	•				•		•	•
EXL EXR	FB	FD	FFDL FFDR	FPEB	FTK	FTKAV FTKRV	ID	INVFRM	LTI	MIP	P	PTOWB
•	•			•	•	•				•		
RD	RECTKALL RECTKBK	RECTKL RECTKR	RT	SCPDRW	TD	TOTSS TOTSSS	TVRV TVRFV TVRVV	VTK	WLI			
•	•	•		•				•				

**Construction Upgrades**

APC	ET	PE
•		•

**Door Options**

CG	DPSRR

**THREE DRAWER BASE BUFFET with DEEP DRAWER**

L G I X

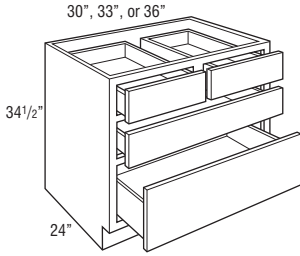

Model	Cubic Feet
<b>3DBDD30</b>	17.6
<b>3DBDD33</b>	19.2
<b>3DBDD36</b>	20.9

- Exterior height of bottom drawer box is 10".

**Custom Modifications**

AUTHL AUTHR	CBO	CCO	CFNT0	CFP	CFRMO	CMAT	CND	DRT	DRWPWR	DRWSEC	DRWTK	EXBKL EXBKR
•	•	•		•	•				•*	•*	•	•
EXL EXR	FB	FD	FFDL FFDR	FPEB	FTK	FTKAV FTKRV	ID	INVFRM	LTI	MIP	P	PTOWB
•	•			•	•	•				•		
RD	RECTKALL RECTKBK	RECTKL RECTKR	RT	SCPDRW	TD	TOTSS TOTSSS	TVRAV TVRFV TVRVV	VTK	WLI			
•	•	•		•				•				

\*Not available on 30" and 33" wide

**Construction Upgrades**

APC	ET	PE
•		•

**Door Options**

CG	DPSRR

**FOUR DRAWER BASE**

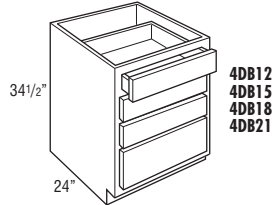

24", 27", 30", 33", or 36"

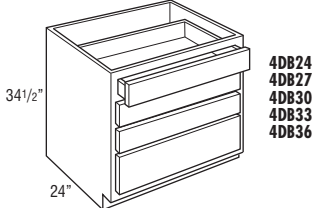

<b>4DB12</b>	7.8
<b>4DB15</b>	9.4
<b>4DB18</b>	11.1
<b>4DB21</b>	12.8
<b>4DB24</b>	14.4
<b>4DB27</b>	15.9
<b>4DB30</b>	17.6
<b>4DB33</b>	19.2
<b>4DB36</b>	20.9

- Exterior height of bottom drawer box is 6 3/8".

**Custom Modifications**

AUTHL AUTHR	CBO	CCO	CFNT0	CFP	CFRMO	CMAT	CND	DRT	DRWPWR	DRWSEC	DRWTK	EXBKL EXBKR
•	•	•		•	•				•*	•*	•*	•
EXL EXR	FB	FD	FFDL FFDR	FPEB	FTK	FTKAV FTKRV	ID	INVFRM	LTI	MIP	P	PTOWB
•	•			•	•	•				•		
RD	RECTKALL RECTKBK	RECTKL RECTKR	RT	SCPDRW	TD	TOTSS TOTSSS	TVRAV TVRFV TVRVV	VTK	WLI			
•	•	•		•				•				

\*Not available on 12" and 15" wide \*Available only on 18", 21", and 24" wide ▲Not available on 12" wide

**Construction Upgrades**

APC	ET	PE
•		•

**Door Options**

CG	DPSRR

**FOUR DRAWER BASE with CUTLERY INSERT WOOD ORGANIZER**

LOGIX

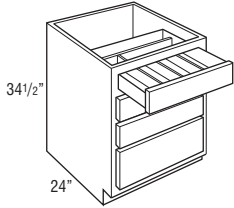

Model	Cubic Feet
4DB15CIW	9.4
4DB18CIW	11.1
4DB21CIW	12.8
4DB24CIW	14.4

- Cutlery Insert Wood Organizer is also available as an accessory. See page 418.
- Exterior height of bottom drawer box is 6 3/8".

**Custom Modifications**

AUTHL AUTHR	CBO	CCO	CFNTD	CFP	CFRMO	CMAT	CND	DRT	DRWPWR	DRWSEC	DRWTK	EXBKL EXBKR
•	•	•			•						•*	•
EXL EXR	FB	FD	FFDL FFDR	FPEB	FTK	FTKAV FTKRV	ID	INVFRM	LTI	MIP	P	PTOWB
•	•			•	•	•				•		
RD	RECTKALL RECTKBK	RECTKL RECTKR	RT	SCPDRW	TD	TOTSS TOTSSS	TVRAV TVRFV TVRVV	VTK	WLI			
	•	•						•				

\*Not available on 15" wide

**Construction Upgrades**

APC	ET	PE
•		•

**Door Options**

CG	DPSRR

**FOUR DRAWER BASE with WOOD TIERED CUTLERY DIVIDER DRAWER**

LOGIX

15", 18", 21", or 24"

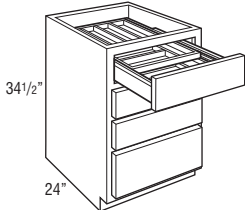

Model	Cubic Feet
4DB15WTC	9.4
4DB18WTC	11.1
4DB21WTC	12.8
4DB24WTC	14.4

- Exterior WTC drawer box height is 3 3/4", interior height of top and bottom tier is 1 3/8".
- Wood Tiered Cutlery Divider Drawer is also available as an accessory. See page 418.
- Exterior height of bottom drawer box is 6 3/8".

**Custom Modifications**

AUTHL AUTHR	CBO	CCO	CFNTD	CFP	CFRMO	CMAT	CND	DRT	DRWPWR	DRWSEC	DRWTK	EXBKL EXBKR
•	•	•			•						•*	•
EXL EXR	FB	FD	FFDL FFDR	FPEB	FTK	FTKAV FTKRV	ID	INVFRM	LTI	MIP	P	PTOWB
•	•			•	•	•				•		
RD	RECTKALL RECTKBK	RECTKL RECTKR	RT	SCPDRW	TD	TOTSS TOTSSS	TVRAV TVRFV TVRVV	VTK	WLI			
	•	•						•				

\*Not available on 15" wide

**Construction Upgrades**

APC	ET	PE
•		•

**Door Options**

CG	DPSRR

**FOUR DRAWER BASE with WOOD TIERED K-CUP\* DRAWER**

L O G I X

Model	Cubic Feet
<b>4DB18KUCP</b>	11.1

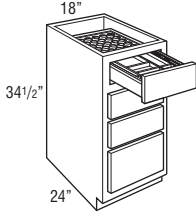

- Holds 40 K-Cups.
  - Exterior height of bottom drawer box is 6 3/8".
  - Exterior Wood Tiered K-Cup drawer box height is 3 3/4", interior height of top tier is 1 5/8", and interior height of bottom tier is 1 3/8".
  - The Wood Tiered K-Cup Drawer is compatible with K-Cup pods only.
  - Wood Tiered K-Cup Drawer is also available as an accessory. See page 419.
- \*K-Cup is a registered trademark of Keurig Green Mountain, Inc.

**Custom Modifications**

AUTHL AUTHR	CBO	CCO	CFNT0	CFP	CFRMO	CMAT	CND	DRT	DRWPWR	DRWSEC	DRWTK	EXBKL EXBKR
•	•	•			•						•	•
EXL EXR	FB	FD	FFDL FFDR	FPEB	FTK	FTKAV FTKRV	ID	INVFRM	LTI	MIP	P	PTOWB
•	•			•	•	•				•		
RD	RECTKALL RECTKBK	RECTKL RECTKR	RT	SCPORW	TD	TOTSS TOTSSS	TVRAV TVRFV TVRVV	VTK	WLI			
•	•	•						•				

**Construction Upgrades**

APC	ET	PE
•		•

**Door Options**

CG	DPSRR

**BASE WASTEBASKET**

L O G I X

<b>BWB15</b>	9.4
<b>BWB152</b>	9.4
<b>BWB18</b>	11.1
<b>BWB21</b>	12.8

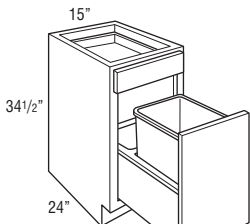

**BWB15**

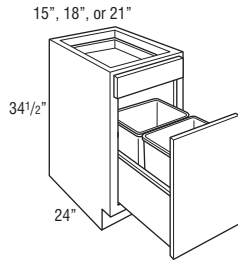

**BWB152  
BWB18  
BWB21**

- BWB15 includes one 35 quart gray wastebasket and one trash bag storage area.
- BWB152 includes two 27 quart gray wastebaskets.
- BWB18 and BWB21 include two 35 quart gray wastebaskets.
- BWB15 and BWB18 can be reduced in depth to 21". When reduced, BWB15 includes one wastebasket. When reduced, BWB18 includes one wastebasket and one trash bag storage area.
- Wastebasket lid available for purchase separately, see page 417. BWBLID fits 35 quart wastebaskets.
- BWBLID can only be used on the front trash can of BWB18 and BWB21.
- Pull-out features undermount Smart Stop guides.

**Custom Modifications**

AUTHL AUTHR	CBO	CCO	CFNT0	CFP	CFRMO	CMAT	CND	DRT	DRWPWR	DRWSEC	DRWTK	EXBKL EXBKR
•	•	•		•	•		•		•*	•*	•*	•
EXL EXR	FB	FD	FFDL FFDR	FPEB	FTK	FTKAV FTKRV	ID	INVFRM	LTI	MIP	P	PTOWB
•	•			•	•	•				•		•
RD	RECTKALL RECTKBK	RECTKL RECTKR	RT	SCPORW	TD	TOTSS TOTSSS	TVRAV TVRFV TVRVV	VTK	WLI			
•*	•	•						•	•			

\*Not available on 15" wide

\*Not available on BWB152 and BWB21

**Construction Upgrades**

APC	ET	PE
•		•

**Door Options**

CG	DPSRR
	•

**BASE PAPER TOWEL CABINET with WASTEBASKET**

LOGIX

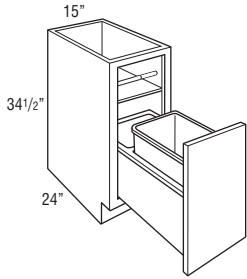

BPT15WB

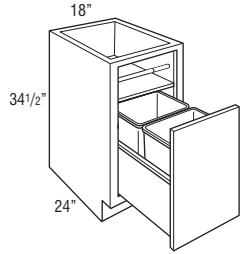

BPT18WB

Model	Cubic Feet
BPT15WB	9.4
BPT18WB	11.1

- Upper section of cabinet features an open cubby area with veneer finished interior sides and fixed shelf, a gray tension rod for easy removal, and a storage area behind the paper towel roll for an additional three to four paper towel rolls. Maximum paper towel diameter is 6".
- Cabinet back and lower section of cabinet has standard interior.
- BPT15WB includes one 35 quart gray wastebasket and one trash bag storage area.
- BPT18WB includes two 35 quart gray wastebaskets.
- Can be reduced in depth to 21". When reduced, BPT15WB includes one wastebasket. When reduced, BPT18WB includes one wastebasket and one trash bag storage area.
- Wastebasket lid available for purchase separately, see page 417. BWBLID fits 35 quart wastebaskets.
- BWBLID can only be used on the front trash can of BPT18WB.
- Pull-out features undermount Smart Stop guides.

**Custom Modifications**

AUTHL	AUTHR	CBO	CCO	CFNTO	CFP	CFRMO	CMAT	CND	DRT	DRWPWR	DRWSEC	DRWTK	EXBKL	EXBKR	
•	•	•										•	•		
EXL	EXR	FB	FD	FFDL	FFDR	FPEB	FTK	FTKAV	FTKRV	ID	INVFRM	LTI	MIP	P	PTOWB
						•	•	•					•		•
RD	RECTKALL	RECTKRBK	RECTKLR	RT	SCPDRW	TD	TOTSS	TOTSSS	TVRAV	TVRFV	TVRVV	VTK	WLI		
•	•	•										•	•		

**Construction Upgrades**

APC	ET	PE
•		•

**Door Options**

CG	DPSRR
	•

**BASE WASTEBASKET FULL HEIGHT**

LOGIX

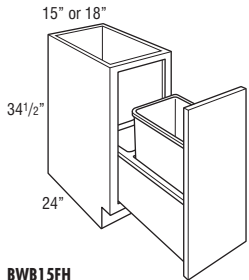

BWB15FH  
BWB18FH

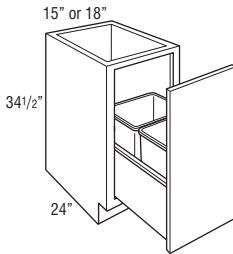

BWB15FH2  
BWB18FH2

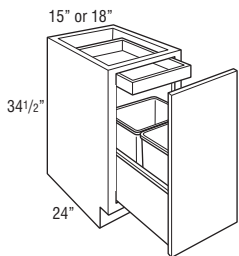

BWB15FHRT2  
BWB18FHRT2

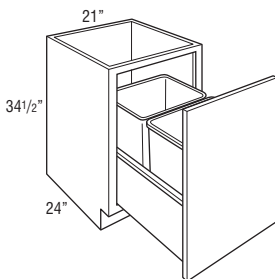

BWB21FH

BWB15FH	9.4
BWB18FH	11.1
BWB15FH2	9.4
BWB18FH2	11.1
BWB15FHRT2	9.4
BWB18FHRT2	11.1
BWB21FH	12.8

- BWB15FH and BWB18FH include one 50 quart gray wastebasket and one trash bag storage area.
- BWB15FH2 includes two 27 quart gray wastebaskets.
- BWB18FH2 includes two 35 quart gray wastebaskets.
- BWB15FHRT2 includes two 27 quart gray wastebaskets and one roll tray.
- BWB18FHRT2 includes two 35 quart gray wastebaskets and one roll tray.
- BWB21FH has two 50 quart gray wastebaskets.
- Wastebasket lid available for purchase separately, see page 417. BWBLID fits 35 quart wastebaskets. BWBFHLID fits 50 quart wastebaskets.
- BWBLID can only be used on the front trash can of BWB18FH2 and BWB18FHRT2.
- BWBFHLID can only be used on the front trash can of BWB21FH.
- Pull-out features undermount Smart Stop guides.

**Custom Modifications**

AUTHL	AUTHR	CBO	CCO	CFNTO	CFP	CFRMO	CMAT	CND	DRT	DRWPWR	DRWSEC	DRWTK	EXBKL	EXBKR	
•	•	•										•*	•		
EXL	EXR	FB	FD	FFDL	FFDR	FPEB	FTK	FTKAV	FTKRV	ID	INVFRM	LTI	MIP	P	PTOWB
						•	•	•					•		•
RD	RECTKALL	RECTKRBK	RECTKLR	RT	SCPDRW	TD	TOTSS	TOTSSS	TVRAV	TVRFV	TVRVV	VTK	WLI		
	•	•										•	•		

\*Not available on 15" wide

**Construction Upgrades**

APC	ET	PE
•		•

**Door Options**

CG	DPSRR
	•



**BASE PAPER TOWEL CABINET with WASTEBASKET, FULL HEIGHT**

L O G I X

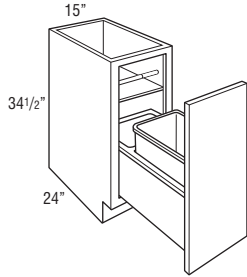

**BPT15WBFH**

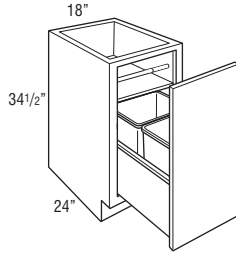

**BPT18WBFH**

Model	Cubic Feet
<b>BPT15WBFH</b>	9.4
<b>BPT18WBFH</b>	11.1

- Upper section of cabinet features a cubby area with veneer finished interior sides and fixed shelf, a gray tension rod for easy removal, and a storage area behind the paper towel roll for an additional three to four paper towel rolls. Maximum paper towel diameter is 6".
- Cabinet back and lower section of cabinet has standard interior.
- BPT15WBFH includes one 35 quart gray wastebasket and one trash bag storage area.
- BPT18WBFH includes two 35 quart gray wastebaskets.
- Can be reduced in depth to 21". When reduced, BPT15WBFH includes one wastebasket. When reduced, BPT18WBFH includes one wastebasket and one trash bag storage area.
- Wastebasket lid available for purchase separately, see page 417. BWBLID fits 35 quart wastebaskets.
- BWBLID can only be used on the front trash can of BPT18WBFH.
- Pull-out features undermount Smart Stop guides.

**Custom Modifications**

AUTHL AUTHR	CBO	CCO	CFNT0	CFP	CFRMO	CMAT	CND	DRT	DRWPWR	DRWSEC	DRWTK	EXBKL EXBKR
•	•	•									•	•
EXL EXR	FB	FD	FFDL FFDR	FPEB	FTK	FTKAV FTKRV	ID	INVFRM	LTI	MIP	P	PTOWB
				•	•	•				•		•
RD	RECTKALL RECTKBK	RECTKL RECTKR	RT	SCPDRW	TD	TOTSS TOTSSS	TVRAV TVRFV TVRVV	VTK	WLI			
•	•	•						•	•			

**Construction Upgrades**

APC	ET	PE
•		•

**Door Options**

CG	DPSRR
	•

**BASE BIN TRAY PULL-OUT**

L O G I X

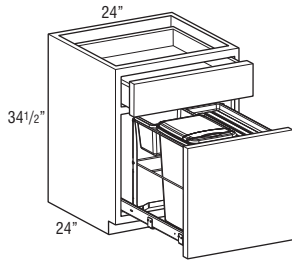

Model	Cubic Feet
<b>BBTP24</b>	14.4

- Door mounted pull-out features Smart Stop guides with chrome rails, gray 35 quart wastebasket with lid, gray bin, and two gray plastic trays. All items can be removed for cleaning.
- Bottom of pull-out has a removable gray plastic liner.
- Wastebasket lid available for purchase separately, see page 417. BWBLID fits 35 quart wastebaskets.

**Custom Modifications**

AUTHL AUTHR	CBO	CCO	CFNT0	CFP	CFRMO	CMAT	CND	DRT	DRWPWR	DRWSEC	DRWTK	EXBKL EXBKR
•	•	•		•	•				•	•	•	•
EXL EXR	FB	FD	FFDL FFDR	FPEB	FTK	FTKAV FTKRV	ID	INVFRM	LTI	MIP	P	PTOWB
•	•			•	•	•				•		
RD	RECTKALL RECTKBK	RECTKL RECTKR	RT	SCPDRW	TD	TOTSS TOTSSS	TVRAV TVRFV TVRVV	VTK	WLI			
•	•	•		•				•	•			

**Construction Upgrades**

APC	ET	PE
•		•

**Door Options**

CG	DPSRR
	•

**BASE BIN TRAY PULL-OUT with PET FEEDING DRAWER**

LOGIX

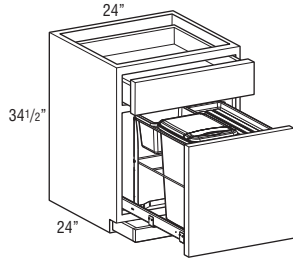

Model	Cubic Feet
BBTP24PFD	14.4

- Door mounted pull-out features Smart Stop guides with chrome rails, gray 35 quart wastebasket with lid, gray bin, and two gray plastic trays. All items can be removed for cleaning.
- Bottom of pull-out has a removable gray plastic liner.
- Pet feeding drawer in the toekick area features push-to-open guides with a removable gray plastic drawer insert.
- Wastebasket lid available for purchase separately, see page 417. BWBLID fits 35 quart wastebaskets.

**Custom Modifications**

AUTHL AUTHR	CBO	CCO	CFNT0	CFP	CFRMO	CMAT	CND	DRT	DRWPWR	DRWSEC	DRWTK	EXBKL EXBKR
•		•		•	•				•	•	STD	•
EXL EXR	FB	FD	FFDL FFDR	FPEB	FTK	FTKAV FTKFV	ID	INVFRM	LTI	MIP	P	PTOWB
•	•			•						•		
RD	RECTKALL RECTKBK	RECTKL RECTKR	RT	SCPDRW	TD	TOTSS TOTSSS	TVRAV TVRFV TVRVV	VTK	WLI			
	•	•							•			

**Construction Upgrades**

APC	ET	PE
•		•

**Door Options**

CG	DPSRR
	•

**BASE BIN TRAY PULL-OUT FULL HEIGHT**

LOGIX

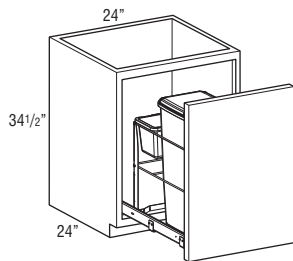

Model	Cubic Feet
BBTP24FH	14.4

- Door mounted pull-out features Smart Stop guides with chrome rails, gray 50 quart wastebasket with lid, gray bin, and two gray plastic trays. All items can be removed for cleaning.
- Bottom of pull-out has a removable gray plastic liner.
- Wastebasket lid available for purchase separately, see page 417. BWBFHLID fits 50 quart wastebaskets.

**Custom Modifications**

AUTHL AUTHR	CBO	CCO	CFNT0	CFP	CFRMO	CMAT	CND	DRT	DRWPWR	DRWSEC	DRWTK	EXBKL EXBKR
•		•			•						•	•
EXL EXR	FB	FD	FFDL FFDR	FPEB	FTK	FTKAV FTKFV	ID	INVFRM	LTI	MIP	P	PTOWB
•	•			•	•	•				•		
RD	RECTKALL RECTKBK	RECTKL RECTKR	RT	SCPDRW	TD	TOTSS TOTSSS	TVRAV TVRFV TVRVV	VTK	WLI			
	•	•						•	•			

**Construction Upgrades**

APC	ET	PE
•		•

**Door Options**

CG	DPSRR
	•

**BASE BIN TRAY PULL-OUT FULL HEIGHT with PET FEEDING DRAWER**

LOGIX

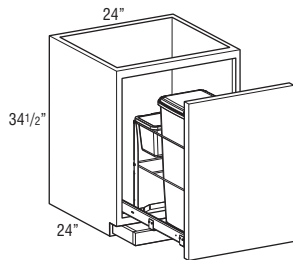

Model	Cubic Feet
BBTP24FHPFD	14.4

- Door mounted pull-out features Smart Stop guides with chrome rails, gray 50 quart wastebasket with lid, gray bin, and two gray plastic trays. All items can be removed for cleaning.
- Bottom of pull-out has a removable gray plastic liner.
- Pet feeding drawer in the toekick area features push-to-open guides with a removable gray plastic drawer insert.
- Wastebasket lid available for purchase separately, see page 417. BWBFHLID fits 50 quart wastebaskets.

**Custom Modifications**

AUTHL AUTHR	CBO	CCO	CFNT0	CFP	CFRMO	CMAT	CND	DRT	DRWPWR	DRWSEC	DRWTK	EXBKL EXBKR
•		•			•						STD	•
EXL EXR	FB	FD	FFDL FFDR	FPEB	FTK	FTKAV FTKFV	ID	INVFRM	LTI	MIP	P	PTOWB
•	•			•						•		
RD	RECTKALL RECTKBK	RECTKL RECTKR	RT	SCPDRW	TD	TOTSS TOTSSS	TVRAV TVRFV TVRVV	VTK	WLI			
	•	•							•			

**Construction Upgrades**

APC	ET	PE
•		•

**Door Options**

CG	DPSRR
	•

### BASE WINE CUBBY, 24" DEEP

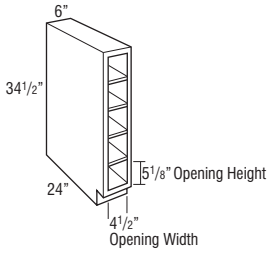

Model	Cubic Feet
<b>BWC6</b>	<b>3.7</b>

- Vertical application only.
- Matching interior.
- Frameless drilled and doweled construction.
- Veneer on 3/4" furniture board core.
- Reduced Depth only available in 3" increments down to 12".

#### Custom Modifications

AUTHL AUTHR	CBO	CCO	CFNT0	CFP	CFRMO	CMAT	CND	DRT	DRWPWR	DRWSEC	DRWTK	EXBKL EXBKR
EXL EXR	FB	FD	FFDL FFDR	FPEB	FTK	FTKAV FTKFV	ID	INVFRM	LTl	MIP	P	PTOWB
	STD											
RD	RECTKALL RECTKBK	RECTKL RECTKR	RT	SCPDRW	TD	TOTSS TOTSSS	TVRAV TVRFV TVRVV	VTK	WLI			
•								•				

#### Construction Upgrades

APC	ET	PE

#### Door Options

CG	DPSRR

### BASE SPICE DRAWER, 24" DEEP

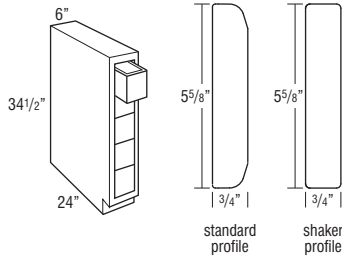

Model	Cubic Feet
<b>BSD6</b>	<b>3.7</b>

- See BWC6 (Base Wine Cubby without Drawers).
- Frameless drilled and doweled construction.
- Veneer on a 3/4" furniture board core.
- Vertical application only.
- Matching interior.
- Includes five 1/2" hardwood drawers with rabbit joint, 21 13/16" deep.
- Drawer opening is 4 1/2" wide x 5 1/8" high.
- Features flush end panels which cannot be skinned.
- If ordered with Heirlooming Technique, will not feature sand-through characteristics.
- Reduced Depth only available in 3" increments down to 12".
- Drawer front is unique to item and will not match profile chosen.
- All styles use standard drawer front profile except Anden, Breman, Caldera, Davis, LaGrange, Leeton, Liberty, Montgomery, Sumner, Trystan, and Wells, which use the shaker profile.
- Granit, Tranter, Wixom, and Warthen drawer fronts will match doors and drawer fronts.

#### Custom Modifications

AUTHL AUTHR	CBO	CCO	CFNT0	CFP	CFRMO	CMAT	CND	DRT	DRWPWR	DRWSEC	DRWTK	EXBKL EXBKR
EXL EXR	FB	FD	FFDL FFDR	FPEB	FTK	FTKAV FTKFV	ID	INVFRM	LTl	MIP	P	PTOWB
	STD											
RD	RECTKALL RECTKBK	RECTKL RECTKR	RT	SCPDRW	TD	TOTSS TOTSSS	TVRAV TVRFV TVRVV	VTK	WLI			
•								•				

#### Construction Upgrades

APC	ET	PE

#### Door Options

CG	DPSRR

**FLOATING ISLAND BASE WITHOUT TOP**

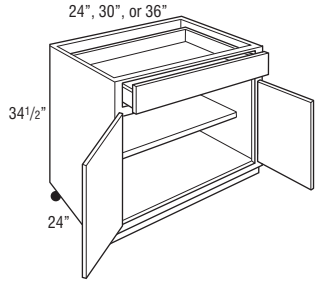

32" high without casters.

Model	Cubic Feet
<b>FICNT24</b>	14.4
<b>FICNT30</b>	17.7
<b>FICNT36</b>	20.9

- 1 full width drawer and 1 adjustable 15" shelf.
- 4 heavy duty locking casters.
- Cabinet back is finished to match cabinet box color.
- Maximum countertop overhang of 1" on all sides.
- Not recommended for use with roll trays.

**Custom Modifications**

AUTHL AUTHR	CBO	CCO	CFNT0	CFP	CFRMO	CMAT	CND	DRT	DRWPWR	DRWSEC	DRWTK	EXBKL EXBKR
•	•	•	•	•	•		•			•*		
EXL EXR	FB	FD	FFDL FFDR	FPEB	FTK	FTKAV FTKFV	ID	INVFRM	LTI	MIP	P	PTOWB
	STD	•		•					•	•		
RD	RECTKALL RECTKBK	RECTKL RECTKR	RT	SCPDRW	TD	TOTSS TOTSSS	TVRAV TVRFV TVRVV	VTK	WLI			
									•			

\*Available only on 24" wide

**Construction Upgrades**

APC	ET	PE
STD		

**Door Options**

CG	DPSRR
•	•

**FLOATING ISLAND BASE**

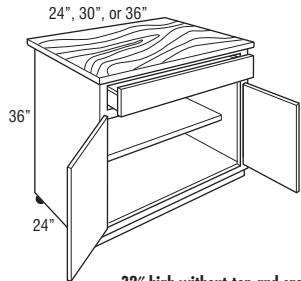

32" high without top and casters.

<b>FIC24</b>	15.0
<b>FIC30</b>	18.5
<b>FIC36</b>	21.9

- 1 full width drawer and 1 adjustable 15" shelf.
- 1 1/2" thick solid Maple top. Top is treated with FDA approved mineral oil.
- Top overhangs 1" on all sides. For field provided countertops, maximum overhang of 1" required on all sides.
- 4 heavy duty locking casters.
- Cabinet back is finished to match cabinet box color.
- Wood tops require regular applications of mineral oil by consumers.
- Not recommended for use with roll trays.

**Custom Modifications**

AUTHL AUTHR	CBO	CCO	CFNT0	CFP	CFRMO	CMAT	CND	DRT	DRWPWR	DRWSEC	DRWTK	EXBKL EXBKR
•	•	•	•	•	•		•			•*		
EXL EXR	FB	FD	FFDL FFDR	FPEB	FTK	FTKAV FTKFV	ID	INVFRM	LTI	MIP	P	PTOWB
	STD	•		•					•	•		
RD	RECTKALL RECTKBK	RECTKL RECTKR	RT	SCPDRW	TD	TOTSS TOTSSS	TVRAV TVRFV TVRVV	VTK	WLI			
									•			

\*Available only on 24" wide

**Construction Upgrades**

APC	ET	PE
STD		

**Door Options**

CG	DPSRR
•	•

### BASE PANTRY PULL-OUT

L O G I X

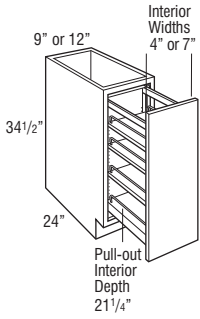

Model	Cubic Feet
<b>BPP9</b>	6.1
<b>BPP12</b>	7.8

- All styles feature a natural finish Smart Stop wood pull-out with adjustable shelves and chrome rail sides. The adjustable rear wall of the pull-out prevents items from falling behind the unit.

#### Custom Modifications

AUTHL AUTHR	CBO	CCO	CFNT0	CFP	CFRMO	CMAT	CND	DRT	DRWPWR	DRWSEC	DRWTK	EXBKL EXBKR
•	•	•			•							•
EXL EXR	FB	FD	FFDL FFDR	FPEB	FTK	FTKAV FTKRV	ID	INVFRM	LTI	MIP	P	PTOWB
•	•			•	•					•		
RD	RECTKALL RECTKBK	RECTKL RECTKR	RT	SCDRW	TD	TOTSS TOTSSS	TVRAV TVRFV TVRVV	VTK	WLI			
	•*	•*						•	•			

\*Not available on 9" wide

#### Construction Upgrades

APC	ET	PE
•		•

#### Door Options

CG	DPSRR
	•

### BASE CONTAINER ORGANIZER PANTRY PULL-OUT

L O G I X

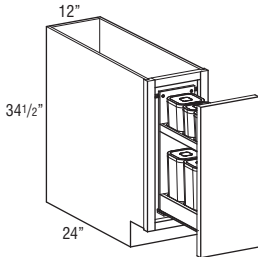

Model	Cubic Feet
<b>BCOPP12</b>	7.8

- Full extension, Smart Stop wood pull-out with natural finish and two fixed shelves.
- Includes seven OXO™ Good Grips POP containers (BPA Free): three 1.7 quart, three 4.3 quart, and one 2.6 quart.

#### Custom Modifications

AUTHL AUTHR	CBO	CCO	CFNT0	CFP	CFRMO	CMAT	CND	DRT	DRWPWR	DRWSEC	DRWTK	EXBKL EXBKR
•	•	•			•							•
EXL EXR	FB	FD	FFDL FFDR	FPEB	FTK	FTKAV FTKRV	ID	INVFRM	LTI	MIP	P	PTOWB
•	•			•	•					•		
RD	RECTKALL RECTKBK	RECTKL RECTKR	RT	SCDRW	TD	TOTSS TOTSSS	TVRAV TVRFV TVRVV	VTK	WLI			
	•	•						•	•			

#### Construction Upgrades

APC	ET	PE
•		•

#### Door Options

CG	DPSRR
	•

### BASE UTENSIL PANTRY PULL-OUT

L O G I X

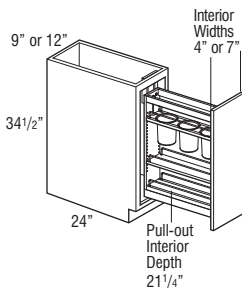

Model	Cubic Feet
<b>BUPP9</b>	5.8
<b>BUPP12</b>	7.5

- All styles feature a natural finish Smart Stop wood pull-out with two adjustable shelves (including canister shelf) and one fixed shelf with chrome rail sides. Top adjustable shelf features three stainless steel canisters for utensils. The adjustable rear wall of the pull-out prevents items from falling behind the unit.
- BUPP9 canisters are 5.85" tall and have an inside diameter of 4.3".
- BUPP12 canisters are 6.7" tall and have an inside diameter of 5".

#### Custom Modifications

AUTHL AUTHR	CBO	CCO	CFNT0	CFP	CFRMO	CMAT	CND	DRT	DRWPWR	DRWSEC	DRWTK	EXBKL EXBKR
•	•	•			•							•
EXL EXR	FB	FD	FFDL FFDR	FPEB	FTK	FTKAV FTKRV	ID	INVFRM	LTI	MIP	P	PTOWB
•	•			•	•					•		
RD	RECTKALL RECTKBK	RECTKL RECTKR	RT	SCDRW	TD	TOTSS TOTSSS	TVRAV TVRFV TVRVV	VTK	WLI			
	•*	•*						•	•			

\*Not available on 9" wide

#### Construction Upgrades

APC	ET	PE
•		•

#### Door Options

CG	DPSRR
	•

**BASE UTENSIL PANTRY PULL-OUT with KNIFE BLOCK**

LOGIX

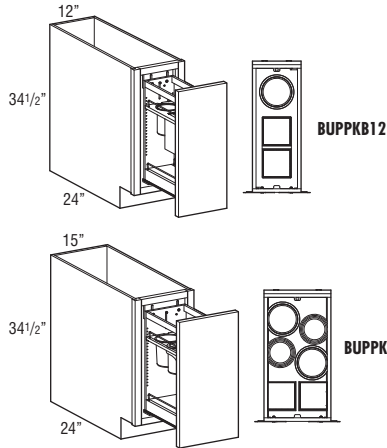

Model	Cubic Feet
<b>BUppKB12</b>	7.8
<b>BUppKB15</b>	9.4

- Full extension, Smart Stop wood pull-out with natural finish and one fixed shelf.
- BUppKB12 features an adjustable shelf with two knife blocks, one stainless steel canister and one fixed shelf with chrome rails. Canister is 6.7" tall and has an inside diameter of 5".
- BUppKB15 features an adjustable shelf with two knife blocks, four stainless steel canisters and one fixed shelf with chrome rails. Two canisters are 5.85" tall and have an inside diameter of 4.3", and the other two are 6.7" tall with an inside diameter of 5".
- Knife block features movable flex rods that adjust to hold a multitude of knives.
- Includes adjustable rear wall for extra strength and stability.
- Adjustable shelf is easily reversible for placement of knife blocks in the front or rear.

**Custom Modifications**

AUTHL AUTHR	CBO	CCO	CFNT0	CFP	CFRMO	CMAT	CND	DRT	DRWPWR	DRWSEC	DRWTK	EXBKL EXBKR
•	•	•			•							•
EXL EXR	FB	FD	FFDL FFDR	FPEB	FTK	FTKAV FTKRV	ID	INVFRM	LTI	MIP	P	PTOWB
•	•			•	•	•*				•		
RD	RECTKALL RECTKBL	RECTKL RECTKR	RT	SCPDRW	TD	TOTSS TOTSSS	TAVRAV TVRFV TVRVV	VTK	WLI			
	•	•						•	•			

\*Not available on 12" wide

**Construction Upgrades**

APC	ET	PE
•		•

**Door Options**

CG	DPSRR
	•

**BASE BOX COLUMN PULL-OUT**

LOGIX

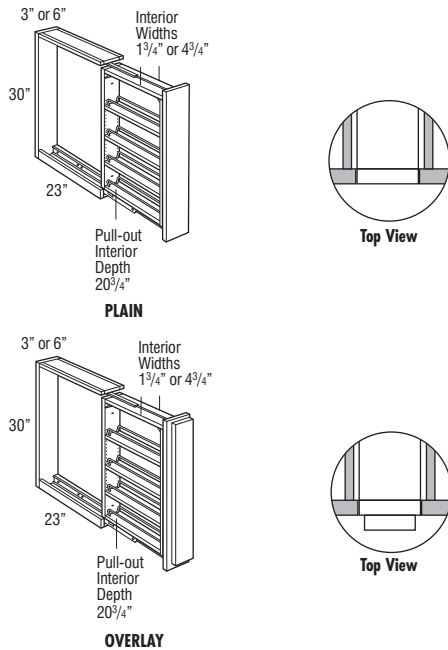

<b>BBCP03</b> (Plain)	1.3
<b>BBCP06</b> (Plain)	2.5
<b>BBCP03OL</b> (Overlay)	1.3
<b>BBCP06OL</b> (Overlay)	2.5

- Recommend installation between two cabinets. Can be installed on the end of a run or adjacent to an appliance with a 3/4" thick end panel.
- Filler is included but unattached.
- Install unit before removing shipping brace and attaching filler.
- Overlay application includes profiled full overlay filler.
- Decorative hardware required on base units.
- Modifications not available.
- Toekick not included; must be built up in the field.
- If installed next to an appliance an End Panel must be installed onto the pull-out adjacent to the appliance.
- All styles feature a natural finish Smart Stop wood pull-out with adjustable shelves and chrome rail sides.
- BBCP03 and BBCP06 will not feature sand-through characteristics if ordered with Heirloom Technique.
- In order to allow proper clearance for opening and closing, allow an additional 1/8" space between adjacent cabinet face frames. The 3" wide pull-outs require 3 1/8" space and the 6" wide pull-outs require 6 1/8" space. Spacers are included with the pull-outs to allow for proper installation.
- For full access from both sides of unit, do not install against a wall or next to deeper appliances and cabinets.

**MODIFICATIONS**

No modifications available for these products.

**Finish Techniques**

Distressing	Heirlooming
•	•*

\*Not available on Plain

**BASE MESSAGE CENTER**

L O G I X

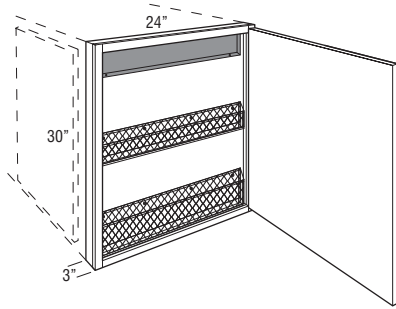

Model	Cubic Feet
<b>BMC24 L or R</b>	<b>2.4</b>

- Includes magazine holder, bulletin board, and mail holder.
- Not recommended for use next to a Peninsula cabinet due to the additional 1/4" cabinet depth.
- Door will open 90° without decorative hardware.
- Cabinet should be hinged on wall side.
- For proper installation, adjacent cabinet must have FPEB or 1/4" skin applied.
- Embellishments or overlay fillers can be used on side of cabinet to add a decorative touch.

**Custom Modifications**

AUTHL AUTHR	CBO	CCO	CFNT0	CFP	CFRMO	CMAT	CND	DRT	DRWPWR	DRWSEC	DRWTK	EXBKL EXBKR
	•	•										
EXL EXR	FB	FD	FFDL FFDR	FPEB	FTK	FTKAV FTKRV	ID	INVFRM	LTl	MIP	P	PTOWB
				STD						•		
RD	RECTKALL RECTKBK	RECTKL RECTKR	RT	SCPDRW	TD	TOTSS TOTSSS	TVRAV TVRFV TVRVV	VTK	WLI			
									•			

**Construction Upgrades**

APC	ET	PE
•		

**Door Options**

CG	DPSRR
	•

**BASE DROP-IN RANGE CABINET**

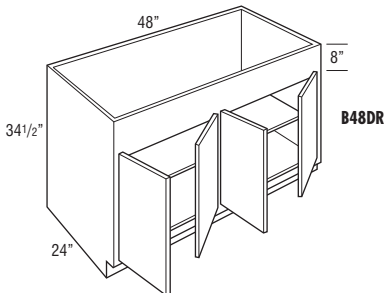
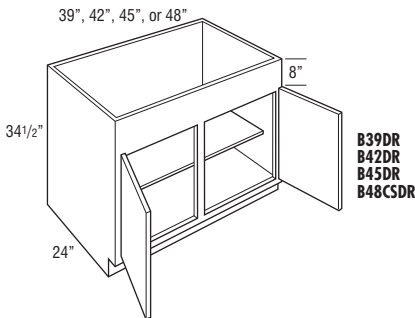
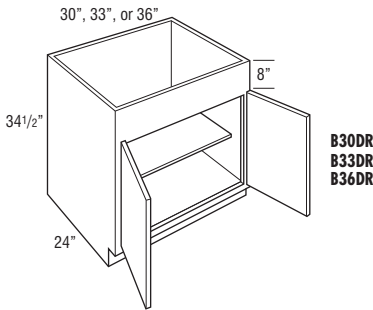

<b>B30DR</b>	<b>17.4</b>
<b>B33DR</b>	<b>19.0</b>
<b>B36DR</b>	<b>20.7</b>
<b>B39DR</b>	<b>22.4</b>
<b>B42DR</b>	<b>24.0</b>
<b>B45DR</b>	<b>25.7</b>
<b>B48CSDR</b>	<b>27.3</b>
<b>B48DR</b>	<b>27.3</b>

- 8" panel can be trimmed up to 6 1/2".
- Adjustable 15" deep shelf.
- Can also be used with apron front sinks, refer to manufacturer's dimension requirements.

**Custom Modifications**

AUTHL AUTHR	CBO	CCO	CFNT0	CFP	CFRMO	CMAT	CND	DRT	DRWPWR	DRWSEC	DRWTK	EXBKL EXBKR
•	•	•	•		•						•*	•
EXL EXR	FB	FD	FFDL FFDR	FPEB	FTK	FTKAV FTKRV	ID	INVFRM	LTl	MIP	P	PTOWB
•	•	•		•	•	•	•		•	•		
RD	RECTKALL RECTKBK	RECTKL RECTKR	RT	SCPDRW	TD	TOTSS TOTSSS	TVRAV TVRFV TVRVV	VTK	WLI			
•	•	•	•					•	•			

\*Available only on 30", 33", and 36" wide

**Construction Upgrades**

APC	ET	PE
•		•

**Door Options**

CG	DPSRR
•	•

**BASE OVEN CABINET**

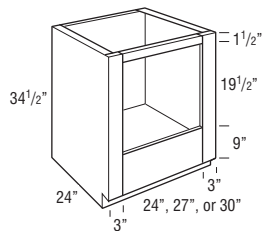

Model	Opening Width	Maximum Width	Opening Height	Maximum Height*
B030	24"	28 1/2"	19 1/2"	27 1/2"
B033	27"	31 1/2"	19 1/2"	27 1/2"
B036	30"	34 1/2"	19 1/2"	27 1/2"

\*Top frame cross rail can be removed during field installation if cabinet is properly installed between two adjacent cabinets, increasing the maximum height to 28 1/4".

Model	Cubic Feet
B030	17.7
B033	19.6
B036	21.1

- Oven cabinet has laminated interior.
- May not hold cooktop and slide-in oven combination. Refer to cooktop and slide-in oven manufacturer specifications.
- If ordered with Heirlooming Technique, will not feature sand-through characteristics.
- For built-in appliance support, OCINSTALLKIT is included in 24" deep oven cabinets (see page 422 for details), but will not be included when depth is modified.

**Custom Modifications**

AUTHL AUTHR	CBO	CCO	CFNT0	CFP	CFRMO	CMAT	CND	DRT	DRWPWR	DRWSEC	DRWTK	EXBKL EXBKR
•					•						•	•
EXL EXR	FB	FD	FFDL FFDR	FPEB	FTK	FTKAV FTKFV	ID	INVFRM	LTI	MIP	P	PTOWB
•	•			•	•	•	•			•		
RD	RECTKALL RECTKBK	RECTKL RECTKR	RT	SCPDRW	TD	TOTSS TOTSSS	TAVRAV TVRFV TVRVV	VTK	WLI			
•	•	•						•				

**Construction Upgrades**

APC	ET	PE
•		•

**Door Options**

CG	DPSRR

**BASE BUILT-IN MICROWAVE CABINET with DRAWER**

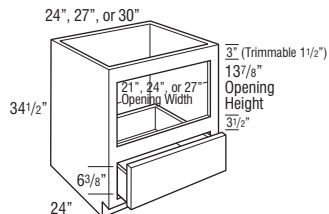

Model	Opening Width	Maximum Width	Opening Height	Maximum Height
BBMWD24	21"	22 1/2"	13 7/8"	16 7/8"
BBMWD27	24"	25 1/2"	13 7/8"	16 7/8"
BBMWD30	27"	28 1/2"	13 7/8"	16 7/8"

<b>BBMWD24</b>	14.4
<b>BBMWD27</b>	16.1
<b>BBMWD30</b>	17.7

- Standard interior.
- For built-in appliance support, OCINSTALLKIT is included in 24" deep cabinets (see page 422 for details), but will not be included when depth is modified.
- The usable cabinet face height between top of drawer front and top of cabinet is 19 1/8" for partial overlay and 19 3/4" for full overlay. Be sure to verify overall appliance height, gap requirements, and cut-out dimensions with cabinet specifications.

**Custom Modifications**

AUTHL AUTHR	CBO	CCO	CFNT0	CFP	CFRMO	CMAT	CND	DRT	DRWPWR	DRWSEC	DRWTK	EXBKL EXBKR
•	•	•			•						•	•
EXL EXR	FB	FD	FFDL FFDR	FPEB	FTK	FTKAV FTKFV	ID	INVFRM	LTI	MIP	P	PTOWB
•	•			•	•	•				•		
RD	RECTKALL RECTKBK	RECTKL RECTKR	RT	SCPDRW	TD	TOTSS TOTSSS	TAVRAV TVRFV TVRVV	VTK	WLI			
•	•	•						•				

**Construction Upgrades**

APC	ET	PE
•		•

**Door Options**

CG	DPSRR



### BASE MICROWAVE CABINET with DRAWER

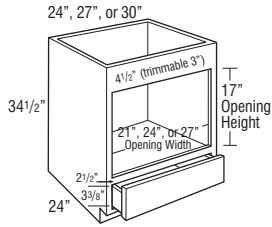

Model	Opening Width	Maximum Width	Opening Height	Maximum Height
BMWD24	21"	22 1/2"	17"	20"
BMWD27	24"	25 1/2"	17"	20"
BMWD30	27"	28 1/2"	17"	20"

Model	Cubic Feet
BMWD24	14.4
BMWD27	16.1
BMWD30	17.7

- Matching Interior Plywood (MIP) standard.
- Reinforced plywood floor.
- The usable cabinet face height between top of drawer front and top of cabinet is 23 1/2" for partial overlay and full overlay. Be sure to verify overall appliance height, gap requirements, and cut-out dimensions with cabinet specifications.

#### Custom Modifications

AUTHL AUTHR	CBO	CCO	CFNT0	CFP	CFRMO	CMAT	CND	DRT	DRWPWR	DRWSEC	DRWTK	EXBKL EXBKR
•	•	•			•						•	•
EXL EXR	FB	FD	FFDL FFDR	FPEB	FTK	FTKAV FTKRV	ID	INVFRM	LTI	MIP	P	PTOWB
•				•	•	•				STD		
RD	RECTKALL RECTKBK	RECTKL RECTKR	RT	SCPDRW	TD	TOTSS TOTSSS	TVRAV TVRFV TVRVV	VTK	WLI			
•	•	•						•				

#### Construction Upgrades

APC	ET	PE

#### Door Options

CG	DPSRR

### BASE MICROWAVE CABINET with DEEP DRAWER

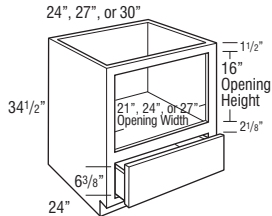

Model	Opening Width	Maximum Width	Opening Height	Maximum Height
BMWD24DD	21"	22 1/2"	16"	16"
BMWD27DD	24"	25 1/2"	16"	16"
BMWD30DD	27"	28 1/2"	16"	16"

Model	Cubic Feet
BMWD24DD	14.4
BMWD27DD	16.1
BMWD30DD	17.7

- Matching Interior Plywood (MIP) standard.
- Reinforced plywood floor.
- The usable cabinet face height between top of drawer front and top of cabinet is 19 1/8" for partial overlay and 18 3/8" for full overlay. Be sure to verify overall appliance height, gap requirements, and cut-out dimensions with cabinet specifications.

#### Custom Modifications

AUTHL AUTHR	CBO	CCO	CFNT0	CFP	CFRMO	CMAT	CND	DRT	DRWPWR	DRWSEC	DRWTK	EXBKL EXBKR
•	•	•			•						•	•
EXL EXR	FB	FD	FFDL FFDR	FPEB	FTK	FTKAV FTKRV	ID	INVFRM	LTI	MIP	P	PTOWB
•				•	•	•				STD		
RD	RECTKALL RECTKBK	RECTKL RECTKR	RT	SCPDRW	TD	TOTSS TOTSSS	TVRAV TVRFV TVRVV	VTK	WLI			
•	•	•						•				

#### Construction Upgrades

APC	ET	PE

#### Door Options

CG	DPSRR

**BASE MICROWAVE CABINET, SINGLE or DOUBLE DOOR, 46 1/2" HIGH**

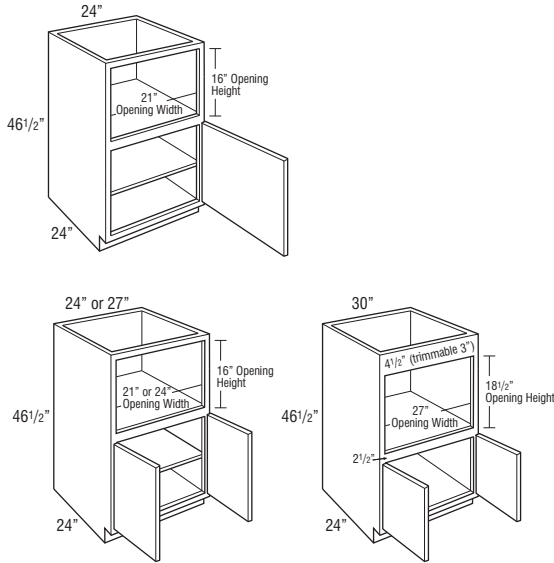

Model	Opening Width	Maximum Width	Opening Height	Maximum Height
BMW2448 L or R	21"	22 1/2"	16"	16"
BMW2448	21"	22 1/2"	16"	16"
BMW2748	24"	25 1/2"	16"	16"
BMW3048	27"	28 1/2"	18 1/2"	21 1/2"

Model	Cubic Feet
BMW2448 L or R	17.6
BMW2448	17.6
BMW2748	19.3
BMW3048	22.3

- Matching Interior Plywood (MIP) standard.
- Reinforced plywood floor.

**Custom Modifications**

AUTHL	AUTHR	CBO	CCO	CFNTO	CFP	CFRMO	CMAT	CND	DRT	DRWPWR	DRWSEC	DRWTK	EXBKL	EXBKR	
•	•	•	•	•	•	•	•	•	•	•	•	•	•	•	
EXL	EXR	FB	FD	FFDL	FFDR	FPEB	FTK	FTKAV	FTKRV	ID	INVFRM	LTI	MIP	P	PTOWB
•	•	•	•	•	•	•	•	•	•	•	•	•	•	•	•
RD	RECTKALL	RECTKRBK	RECTKRL	RECTKR	RT	SCPDRW	TD	TOTSS	TOTSSS	TVRAV	TVRFV	TVRVV	VTK	WLI	
•	•	•	•	•	•	•	•	•	•	•	•	•	•	•	

**Construction Upgrades**

APC	ET	PE
•	•	•

**Door Options**

CG	DPSRR
•	•

**BASE MICROWAVE CABINET with ROLL TRAY, 46 1/2" HIGH**

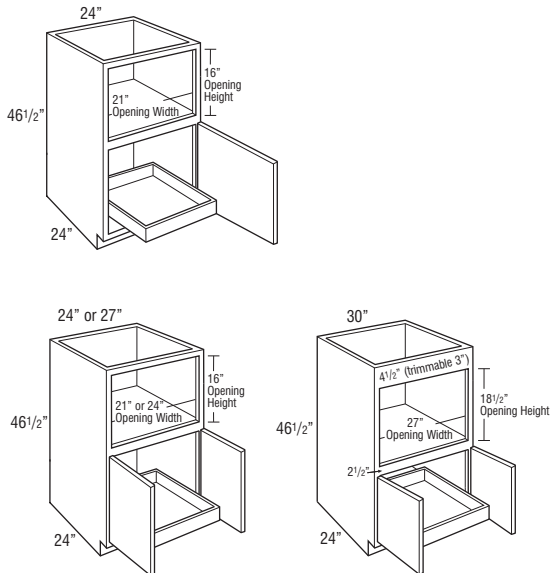

Model	Opening Width	Maximum Width	Opening Height	Maximum Height
BMW2448RT L or R	21"	22 1/2"	16"	16"
BMW2448RT	21"	22 1/2"	16"	16"
BMW2748RT	24"	25 1/2"	16"	16"
BMW3048RT	27"	28 1/2"	18 1/2"	21 1/2"

Model	Cubic Feet
BMW2448RT L or R	17.6
BMW2448RT	17.6
BMW2748RT	19.3
BMW3048RT	22.3

- Matching Interior Plywood (MIP) standard.
- Reinforced plywood floor.

**Custom Modifications**

AUTHL	AUTHR	CBO	CCO	CFNTO	CFP	CFRMO	CMAT	CND	DRT	DRWPWR	DRWSEC	DRWTK	EXBKL	EXBKR	
•	•	•	•	•	•	•	•	•	•	•	•	•	•	•	
EXL	EXR	FB	FD	FFDL	FFDR	FPEB	FTK	FTKAV	FTKRV	ID	INVFRM	LTI	MIP	P	PTOWB
•	•	•	•	•	•	•	•	•	•	•	•	•	•	•	•
RD	RECTKALL	RECTKRBK	RECTKRL	RECTKR	RT	SCPDRW	TD	TOTSS	TOTSSS	TVRAV	TVRFV	TVRVV	VTK	WLI	
•	•	•	•	•	•	•	•	•	•	•	•	•	•	•	

**Construction Upgrades**

APC	ET	PE
•	•	•

**Door Options**

CG	DPSRR
•	•

**BASE CORNER PENINSULA**

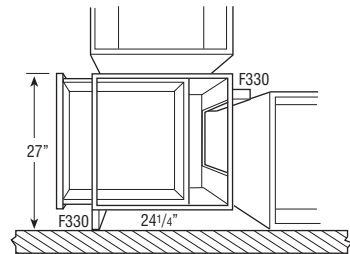

**BCP24 L or R**  
**BCP24**

Model	Cubic Feet
<b>BCP24 L or R</b>	16.2
<b>BCP24</b>	14.4

- Cabinet width is 24".
- Adjustable full depth shelf.
- Includes two 3" fillers, shipped unattached. Fillers are required for drawer and door opening clearance of adjacent cabinets.
- Unfinished toekick on front (B24) and back (BCP) of cabinet.
- Will not accept roll trays.
- Peninsula base cabinets are 1/4" deeper to allow back paneling application on adjacent cabinets in a run with standard 24" deep cabinets.

**Custom Modifications**

AUTHL AUTHR	CBO	CCO	CFNT0	CFP	CFRMO	CMAT	CND	DRT	DRWPWR	DRWSEC	DRWTK	EXBKL EXBKR
•	•	•	•	•	•		•				•	
EXL EXR	FB	FD	FFDL FFDR	FPEB	FTK	FTKAV FTKFV	ID	INVFRM	LTI	MIP	P	PTOWB
•	•			•	•	•			•	•	STD	
RD	RECTKALL RECTKBK	RECTKL RECTKR	RT	SCDRW	TD	TOTSS TOTSSS	TVRAV TVRFV TVRVV	VTK	WLI			
•	STD*	•						•	•			

\*RECTKALL not available

**Construction Upgrades**

APC	ET	PE
•		•

**Door Options**

CG	DPSRR
•	•

**BASE CORNER PENINSULA with FULL HEIGHT DOOR**

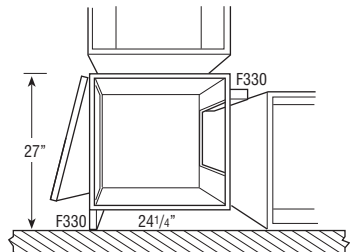

**BCP24FH L or R**

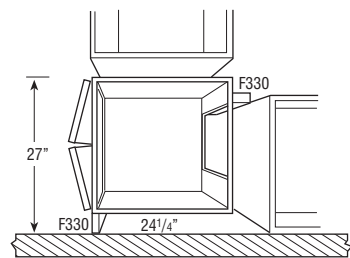

**BCP24FH**

Model	Cubic Feet
<b>BCP24FH L or R</b>	16.2
<b>BCP24FH</b>	14.4

- Cabinet width is 24".
- Adjustable full depth shelf.
- Includes two 3" fillers, shipped unattached. Fillers are required for drawer and door opening clearance of adjacent cabinets.
- Unfinished toekick on front (B24) and back (BCP) of cabinet.
- Will not accept roll trays.
- Peninsula base cabinets are 1/4" deeper to allow back paneling application on adjacent cabinets in a run with standard 24" deep cabinets.

**Custom Modifications**

AUTHL AUTHR	CBO	CCO	CFNT0	CFP	CFRMO	CMAT	CND	DRT	DRWPWR	DRWSEC	DRWTK	EXBKL EXBKR
•	•	•	•		•		•					
EXL EXR	FB	FD	FFDL FFDR	FPEB	FTK	FTKAV FTKFV	ID	INVFRM	LTI	MIP	P	PTOWB
•	•			•	•	•			•	•	STD	
RD	RECTKALL RECTKBK	RECTKL RECTKR	RT	SCDRW	TD	TOTSS TOTSSS	TVRAV TVRFV TVRVV	VTK	WLI			
•	STD*	•						•	•			

\*RECTKALL not available

**Construction Upgrades**

APC	ET	PE
•		•

**Door Options**

CG	DPSRR
•	•

**BASE QUARTER ROUND END SHELF**

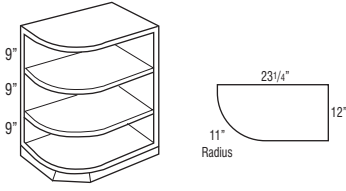

Model	Cubic Feet
<b>BQRES</b>	7.8

- Reversible.
- 12" wide x 23 1/4" deep x 11" radius.
- Separate pedestal base included.
- Angled pedestal design allows easier application of matching toeboard.
- Veneer construction finished to match cabinet face frame.
- Veneer on a 3/4" furniture board core.
- Matching interior.
- Cabinet is to be installed behind the face frame of the adjacent 24" deep base cabinet, features two unfinished back panels.
- If ordered with Heirlooming Technique, will not feature sand-through characteristics.

MODIFICATIONS
No modifications available for these products.

**Construction Upgrades**

APC	ET	PE
•		

**BASE OPEN CABINET with PLAIN BACK**

15", 18", 24", 30", or 36"

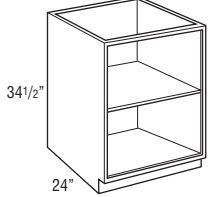

<b>BOCP15</b>	9.4
<b>BOCP18</b>	11.0
<b>BOCP24</b>	14.3
<b>BOCP30</b>	17.6
<b>BOCP36</b>	20.9

- Matching Interior Plywood (MIP) standard.
- Face frame has a profiled inside edge.
- If ordered with Heirlooming Technique, will not feature sand-through characteristics.
- To change the top rail valance, specify one of the following modifications: Arch (TVRAV), Furniture (TVRFV), or Straight Valance (TVRVV).

**Custom Modifications**

AUTHL AUTHR	CBO	CCO	CFNTO	CFP	CFRMO	CMAT	CND	DRT	DRWPWR	DRWSEC	DRWTK	EXBKL EXBKR
•	STD				•						•*	•
EXL EXR	FB	FD	FFDL FFDR	FPEB	FTK	FTKAV FTKFV	ID	INVFRM	LTI	MIP	P	PTOWB
•		STD		•	•	•	•			STD	•	
RD	RECTKALL RECTKBK	RECTKL RECTKR	RT	SCPDRW	TD	TOTSS TOTSSS	TVRAV TVRFV TVRVV	VTK	WLI			
•	•	•					•	•				

\*Not available on 15" wide

**Construction Upgrades**

APC	ET	PE

**Door Options**

CG	DPSRR

### BASE OPEN CABINET with BEADED BACK BACK

15", 18", 24", 30", or 36"

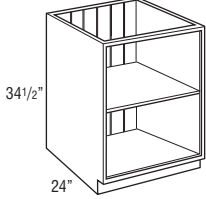

Model	Cubic Feet
<b>BOCB15</b>	9.4
<b>BOCB18</b>	11.0
<b>BOCB24</b>	14.3
<b>BOCB30</b>	17.6
<b>BOCB36</b>	20.9

- Matching Interior Plywood (MIP) standard.
- Beaded back panel is veneer on furniture board core.
- Face frame has a profiled inside edge.
- If ordered with Heirlooming Technique, will not feature sand-through characteristics.
- To change the top rail valance, specify one of the following modifications: Arch (TVRAV), Furniture (TVRFV), or Straight Valance (TVRVV).

#### Custom Modifications

AUTHL AUTHR	CBO	CCO	CFNTO	CFP	CFRMO	CMAT	CND	DRT	DRWPWR	DRWSEC	DRWTK	EXBKL EXBKR
•	STD				•						•*	•
EXL EXR	FB	FD	FFDL FFDR	FPEB	FTK	FTKAV FTKFV	ID	INVFRM	LTI	MIP	P	PTOWB
•		STD		•	•	•	•			STD	•	
RD	RECTKALL RECTKBK	RECTKL RECTKR	RT	SCPORW	TD	TOTSS TOTSSS	TVRAV TVRFV TVRVV	VTK	WLI			
•	•	•					•	•				

\*Not available on 15" wide

#### Construction Upgrades

APC	ET	PE

#### Door Options

CG	DPSRR

### BASE OPEN CABINET with PLAIN BACK and DRAWER

15", 18", 24", 30", or 36"

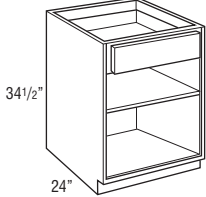

Model	Cubic Feet
<b>BODP15</b>	9.4
<b>BODP18</b>	11.0
<b>BODP24</b>	14.3
<b>BODP30</b>	17.6
<b>BODP36</b>	20.9

- Matching Interior Plywood (MIP) standard.
- If ordered with Heirlooming Technique, will not feature sand-through characteristics.
- To change the top rail valance, specify one of the following modifications: Arch (TVRAV), Furniture (TVRFV), or Straight Valance (TVRVV).

#### Custom Modifications

AUTHL AUTHR	CBO	CCO	CFNTO	CFP	CFRMO	CMAT	CND	DRT	DRWPWR	DRWSEC	DRWTK	EXBKL EXBKR
•	STD				•				•*	•*	•*	•
EXL EXR	FB	FD	FFDL FFDR	FPEB	FTK	FTKAV FTKFV	ID	INVFRM	LTI	MIP	P	PTOWB
•		STD		•	•	•	•			STD	•	
RD	RECTKALL RECTKBK	RECTKL RECTKR	RT	SCPORW	TD	TOTSS TOTSSS	TVRAV TVRFV TVRVV	VTK	WLI			
•	•	•		•			•	•				

\*Not available on 15" wide

\*Available only on 18" and 24" wide

#### Construction Upgrades

APC	ET	PE

#### Door Options

CG	DPSRR

**BASE OPEN CABINET with BEADED BACK and DRAWER**

15", 18", 24", 30", or 36"

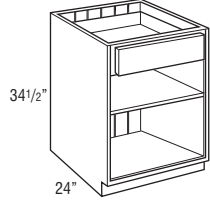

Model	Cubic Feet
<b>BODB15</b>	9.4
<b>BODB18</b>	11.0
<b>BODB24</b>	14.3
<b>BODB30</b>	17.6
<b>BODB36</b>	20.9

- Matching Interior Plywood (MIP) standard.
- Beaded back panel is veneer on furniture board core.
- If ordered with Heirloom Technique, will not feature sand-through characteristics.
- To change the top rail valance, specify one of the following modifications: Arch (TVRAV), Furniture (TVRFV), or Straight Valance (TVRVV).

**Custom Modifications**

AUTHL AUTHR	CBO	CCO	CFNTO	CFP	CFRMO	CMAT	CND	DRT	DRWPWR	DRWSEC	DRWTK	EXBKL EXBKR
•	STD				•				•*	•+	•*	•
EXL EXR	FB	FD	FFDL FFDR	FPEB	FTK	FTKAV FTKFV	ID	INVFRM	LTI	MIP	P	PTOWB
•		STD		•	•	•	•			STD	•	
RD	RECTKALL RECTKBK	RECTKL RECTKR	RT	SCPDRW	TD	TOTSS TOTSSS	TVRAV TVRFV TVRVV	VTK	WLI			
•	•	•		•			•	•				

\*Not available on 15" wide

\*Available only on 18" and 24" wide

**Construction Upgrades**

APC	ET	PE

**Door Options**

CG	DPSRR

# Diamond<sup>®</sup>

## DISTINCTION™ SERIES

### UNIVERSAL DESIGN NOMENCLATURE

All UD Cabinets are 32 1/2" high unless otherwise noted.

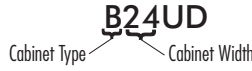

### MODIFICATIONS GRID KEY

- Available Standard on these cabinets
- 5 DAY** 5 Day Express Response Item

### CUSTOM MODIFICATIONS

Mod.	Description	Mod.	Description
ACS	Appliance Cut-out, Single	EXL	Extended Stile - Left
CBO	Cabinet Box Only	EXR	Extended Stile - Right
CCO	Cabinet Case Only	FB	Finished Ends
CFNTO	Cabinet Front Only	FD	Full Depth Shelf
CFP	Cabinet False Panel	FPEB	Furniture Finished Plywood Ends
CFRMO	Cabinet Frame Only	ID	Increased Depth
CMAT	CabMat™	LTI	Light Installed Battery Strip
CND	Cabinet with No Door, with Drawer	MIP	Matching Interior Plywood
DRT	Deep Roll Tray	RD	Reduced Depth
DRWPWR	PowerGlide™ Compact Drawer Outlet	RT	Installed Roll Tray
DRWSEC	Biometric Secured Drawer	SCPDRW	Scooped Drawer
EXBKL	End Extended Back - Left	TOTSS	Tilt-out Tray, Stainless Steel
EXBKR	End Extended Back - Right	TOTSSS	Tilt-out Tray, Stainless Steel Slim
		VTK	Void Toe Kick
		WLI	White Laminate Interior

### CONSTRUCTION UPGRADES

Mod.	Description
APC	All-plywood Construction
PE	Plywood Ends

### DOOR OPTIONS

Mod.	Description
DPSRR	Door Panel - Solid Reverse Raised
MFO	Modified Full Overlay

### UNIVERSAL DESIGN BASE, SINGLE DOOR

12", 15", 18", or 21"

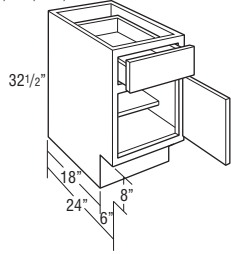

Model	Cubic Feet
<b>B12UD L or R</b>	6.7
<b>B15UD L or R</b>	8.2
<b>B18UD L or R</b>	9.7
<b>B21UD L or R</b>	12.7

- Adjustable 15" deep shelf.
- Optional roll tray kit available for field installation. Not available on B12UD.

#### Custom Modifications

ACS	CBO	CCO	CFNTO	CFP	CFRMO	CMAT	CND	DRT	DRWPWR	DRWSEC	EXBKL EXBKR	EXL EXR
	•	•	•	•	•		•		•*		•	•
	FB	FD	FPEB	ID	LTI	MIP	RD	RT	SCPDRW	TOTSS TOTSSS	VTK	WLI
•	•	•		•*	•	•	•	•	•	•	•	•

\*Not available on 12" and 15" wide    \*Not available on 12" wide

#### Construction Upgrades

APC	PE
•	•

#### Door Options

DPSRR	MFO
•	

### UNIVERSAL DESIGN BASE, DOUBLE DOOR

24", 30", or 36"

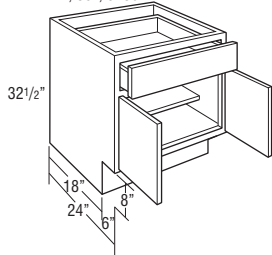

<b>B24UD</b>	14.2
<b>B30UD</b>	15.8
<b>B36UD</b>	16.8

- Adjustable 15" deep shelf.
- Optional roll trays kit available for field installation.

#### Custom Modifications

ACS	CBO	CCO	CFNTO	CFP	CFRMO	CMAT	CND	DRT	DRWPWR	DRWSEC	EXBKL EXBKR	EXL EXR
	•	•	•	•	•		•		•*		•	•
	FB	FD	FPEB	ID	LTI	MIP	RD	RT	SCPDRW	TOTSS TOTSSS	VTK	WLI
•	•	•		•	•	•	•	•	•	•	•	•

\*Available only on 24" wide

#### Construction Upgrades

APC	PE
•	•

#### Door Options

DPSRR	MFO
•	

**UNIVERSAL DESIGN BASE with ROLL TRAY, SINGLE DOOR**

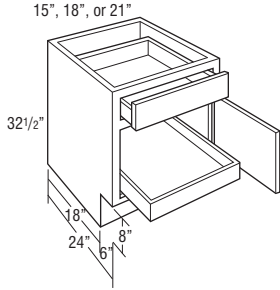

Model	Cubic Feet
<b>B15RTUD L or R</b>	8.2
<b>B18RTUD L or R</b>	9.7
<b>B21RTUD L or R</b>	12.7

- 1 roll tray standard.

**Custom Modifications**

ACS	CBO	CCO	CFNTD	CFP	CFRMO	CMAT	CND	DRT	DRWPWR	DRWSEC	EXBKL EXBKR	EXL EXR
	•	•	•	•	•		•	•	•*	•*	•	•
FB	FD	FPEB	ID	LTI	MIP	RD	RT	SCPDRW	TOTSS TOTSSS	VTK	WLI	
•		•			•	•		•		•	•	

\*Not available on 15" wide

**Construction Upgrades**

APC	PE
•	•

**Door Options**

DPSRR	MFO
•	

**UNIVERSAL DESIGN BASE with ROLL TRAY, DOUBLE DOOR**

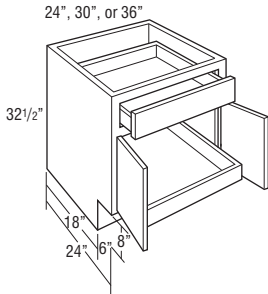

<b>B24RTUD</b>	14.2
<b>B30RTUD</b>	15.8
<b>B36RTUD</b>	16.8

- 1 roll tray standard.
- Top of drawer is 2" from top of cabinet to accommodate installation of a cook top.

**Custom Modifications**

ACS	CBO	CCO	CFNTD	CFP	CFRMO	CMAT	CND	DRT	DRWPWR	DRWSEC	EXBKL EXBKR	EXL EXR
	•	•	•	•	•		•	•	•	•*	•	•
FB	FD	FPEB	ID	LTI	MIP	RD	RT	SCPDRW	TOTSS TOTSSS	VTK	WLI	
•		•			•	•		•		•	•	

\*Available only on 24" wide

**Construction Upgrades**

APC	PE
•	•

**Door Options**

DPSRR	MFO
•	

**UNIVERSAL DESIGN SINK BASE**

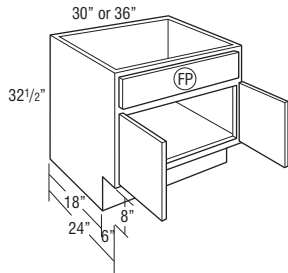

<b>SB30UD</b>	15.8
<b>SB36UD</b>	16.8

- Mini Touch-up Kit (MTUK) included. MTUK includes small touch-up marker and small fill stick.

**Custom Modifications**

ACS	CBO	CCO	CFNTD	CFP	CFRMO	CMAT	CND	DRT	DRWPWR	DRWSEC	EXBKL EXBKR	EXL EXR
	•	•	•	STD	•	•	•				•	•
FB	FD	FPEB	ID	LTI	MIP	RD	RT	SCPDRW	TOTSS TOTSSS	VTK	WLI	
•	•	•		•	•	•		•		•	•	

**Construction Upgrades**

APC	PE
•	•

**Door Options**

DPSRR	MFO
•	

Ⓢ = False Panel



## UNIVERSAL DESIGN SINK BASE with TILT-OUT TRAYS

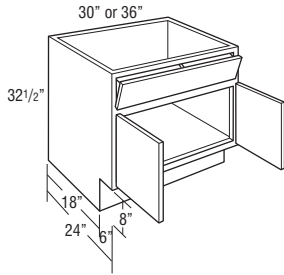

Model	Cubic Feet
SB30STUD	15.8
SB36STUD	16.8

- Tilt-out trays are stain resistant, moisture resistant plastic to allow storage of sponges and other cleaning materials.
- Mini Touch-up Kit (MTUK) included. MTUK includes small touch-up marker and small fill stick.
- Includes two tilt-out trays.
- Tilt-out trays are also available as an accessory for field installation. See page 423.

### Custom Modifications

ACS	CBO	CCO	CFNTO	CFP	CFRMO	CMAT	CND	DRT	DRWPWR	DRWSEC	EXBKL EXBKR	EXL EXR
		•	•		•	•					•	•
FB	FD	FPEB	ID	LTI	MIP	RD	RT	SCPDRW	TOTSS TOTSS	VTK	WLI	
•		•		•	•	•	•			•	•	

### Construction Upgrades

APC	PE
•	•

### Door Options

DPSRR	MFO
•	

## NEW VANITY WALL SINK

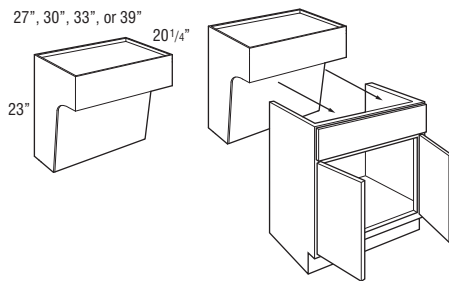

VWS2723	9.7
VWS3023	10.7
VWS3323	12.7
VWS3923	17.8

- Matching Interior Plywood (MIP) standard.
- Recommended installation height of 32" high with 9" of clearance below.
- Front panel is attached with clips for easy removal for access to plumbing.
- Finished veneer plywood exterior and interior.
- For proper installation, cabinet must be secured on each side through both the top and bottom of the back panel into wall studs. Installation instructions and required 3 1/2" installation screws included, standard 2 1/2" installation screws are not sufficient in this application.
- Features a full cabinet top that can be routed for sink installation.
- Approximate weight limit is 400 lbs. per cabinet (includes weight of the cabinet, countertop and contents). Proper installation is required and additional bracing may be required.
- Includes connector clips to mount the sink base to the Removable Vanity Sink Base (RVWS..32).

### Custom Modifications

ACS	CBO	CCO	CFNTO	CFP	CFRMO	CMAT	CND	DRT	DRWPWR	DRWSEC	EXBKL EXBKR	EXL EXR
FB	FD	FPEB	ID	LTI	MIP	RD	RT	SCPDRW	TOTSS TOTSS	VTK	WLI	
		STD			STD							

### Construction Upgrades

APC	PE

### Door Options

DPSRR	MFO

## NEW REMOVABLE VANITY SINK BASE, 21" DEEP

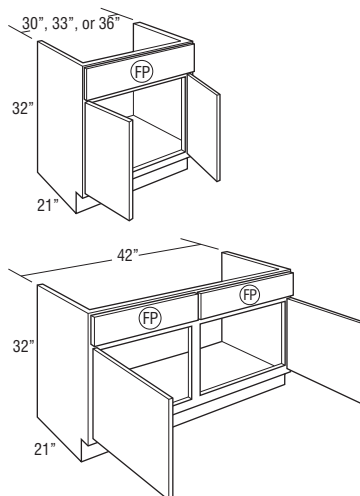

RVWS3032	14.6
RVWS3332	16.0
RVWS3632	17.4
RVWS4232	20.1

- Must be ordered with Vanity Wall Sink (VWS..23), not designed to be a stand-alone unit.
- Cabinet is able to be removed for handicap accessible use.
- Includes connector clips to mount the sink base to the Vanity Wall Sink (VWS..23).
- Available with AUTHL and AUTHR modifications.

### Custom Modifications

ACS	CBO	CCO	CFNTO	CFP	CFRMO	CMAT	CND	DRT	DRWPWR	DRWSEC	EXBKL EXBKR	EXL EXR
		•	•	STD	•	•						•
FB	FD	FPEB	ID	LTI	MIP	RD	RT	SCPDRW	TOTSS TOTSS	VTK	WLI	
		STD		•	•						•	

### Construction Upgrades

APC	PE
STD	

### Door Options

DPSRR	MFO
•	

**UNIVERSAL DESIGN SUPER LAZY SUSAN**

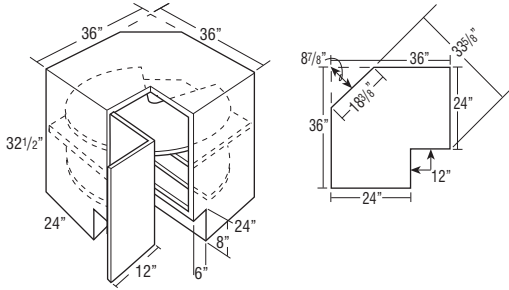

Due to fixed shelf mounting, shelves cannot be retrofitted.

Model	Cubic Feet
<b>SLS36UD L or R</b>	<b>27.7</b>

- SLS36UD L or R wall width is 36" x 36".
- Features two plywood revolving shelves with a 1" plywood lip. Lower shelf is mounted to floor. Upper shelf is mounted to fixed shelf. Fixed shelf is 1/2" thick laminated furniture board.
- Decorative hardware screws must be countersunk to prevent scratching adjacent cabinets and face frame of SLS.
- Integrated soft-close hinge not included.
- Cabinet top features I-beam braces with a center support brace.

**Custom Modifications**

ACS	CBO	CCO	CFNTO	CFP	CFRMO	CMAT	CND	DRT	DRWPWR	DRWSEC	EXBKL EXBKR	EXL EXR
	•	•										
FB	FD	FPEB	ID	LTI	MIP	RD	RT	SCPORW	TOTSS TOTSSS	VTK	WLI	
•		•		•	•						•	•

**Construction Upgrades**

APC	PE
•	•

**Door Options**

DPSRR	MFO
•	

**UNIVERSAL DESIGN THREE DRAWER BASE**

15", 18", or 24"

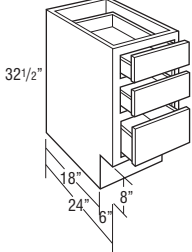

<b>3DB15UD</b>	<b>8.2</b>
<b>3DB18UD</b>	<b>9.7</b>
<b>3DB24UD</b>	<b>14.2</b>

- 1 deep and 2 shallow drawers.

**Custom Modifications**

ACS	CBO	CCO	CFNTO	CFP	CFRMO	CMAT	CND	DRT	DRWPWR	DRWSEC	EXBKL EXBKR	EXL EXR
	•	•		•	•				•*	•*	•	•
FB	FD	FPEB	ID	LTI	MIP	RD	RT	SCPORW	TOTSS TOTSSS	VTK	WLI	
•		•			•	•		•		•		

\*Not available on 15" wide

**Construction Upgrades**

APC	PE
•	•

**Door Options**

DPSRR	MFO

**UNIVERSAL DESIGN BASE MICROWAVE**

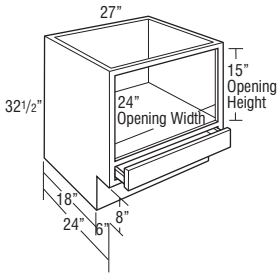

<b>BMW27UD</b>	<b>15.7</b>
----------------	-------------

- 1 shallow drawer below microwave.
- Microwave opening is 24" wide x 15" high.

**Custom Modifications**

ACS	CBO	CCO	CFNTO	CFP	CFRMO	CMAT	CND	DRT	DRWPWR	DRWSEC	EXBKL EXBKR	EXL EXR
	•	•	•		•						•	•
FB	FD	FPEB	ID	LTI	MIP	RD	RT	SCPORW	TOTSS TOTSSS	VTK	WLI	
•	STD	•			STD	•					•	

**Construction Upgrades**

APC	PE

**Door Options**

DPSRR	MFO

## UNIVERSAL DESIGN SINGLE OVEN CABINET, 84" TALL, 24" DEEP

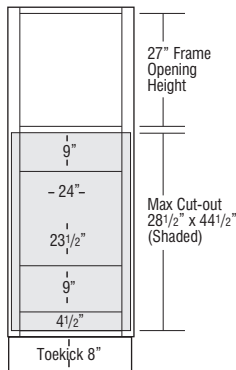
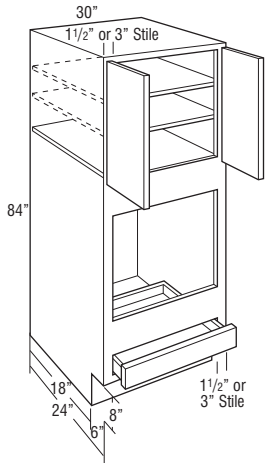

OC308424UD

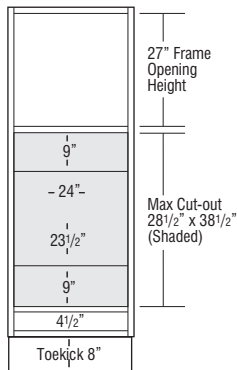

OC308424UDN

Model	Cubic Feet
OC308424UD(N)	41.8

- N represents Narrow Stile cabinets with 1 1/2" wide face frame side stiles and ACS modification availability (see page 46 for ACS specifications). Doors and drawer fronts have a consistent width reveal for full overlay (1/4") and partial overlay (1") and use standard Smart Stop hinges.
- On cabinets with 3" wide face frame side stiles, full overlay styles have a consistent 1/4" width frame reveal and use face mounted Smart Stop hinges. Partial overlay styles have a larger 2 1/2" width reveal, use standard Smart Stop hinges, and are not recommended for stacking applications due to misalignment of door width with cabinets above.
- Cabinets with 3" wide face frames are not available in MDF door styles.
- Two full depth adjustable shelves are included.
- All top and bottom cross rails are 1 1/2" wide.
- Cabinet has 3" stiles on frame.
- Be sure to confirm a heat shield is built into your appliance.
- For built-in appliance support, OCINSTALLKIT is included in 24" deep oven cabinets (see page 422 for details). Oven install kit will not be included when depth is modified.
- Maximum cut-out dimension will allow 1/4" reveal for doors and drawer fronts on full overlay and 1" for partial overlay for trim kit face clearance.

	A Frame Opening Height	B Cut-out Width		C Cut-out Height		Door Height (Upper Section)	
		Min.	Max.	Min.	Max.	Partial Overlay	Full Overlay
OC308424UD	27"	24"	28 1/2"	28 1/2"	44 1/2"	28"	29 1/2"

	A Frame Opening Height	B Cut-out Width (standard)		B Cut-out Width (with ACS modification)			C Cut-out Height		Door Height (Upper Section)	
		Min.	Max.	Min.	Max.	Max. w/ Field Cut	Min.	Max.	Partial Overlay	Full Overlay
OC308424UDN	27"	27"	28 1/2"	24"	27"	28 1/2"	23 1/2"	38 1/2"	28"	29 1/2"

### Custom Modifications

ACS	CBO	CCO	CFNT0	CFP	CFRMO	CMAT	CND	DRT	DRWPWR	DRWSEC	EXBKL EXBKR	EXL EXR
•*	•	•			•		•				•	•
FB	FD	FPEB	ID	LTI	MIP	RD	RT	SCPDRW	TOTSS TOTSSS	VTK	WLI	
•	•	•	•		•	•				•	•	

\*Only available on Narrow Stile (N) cabinets

### Construction Upgrades

APC	PE
•	•

### Door Options

DPSRR	MFO
•	•

## UNIVERSAL DESIGN FILLER

### 3" and 6" Wide Fillers

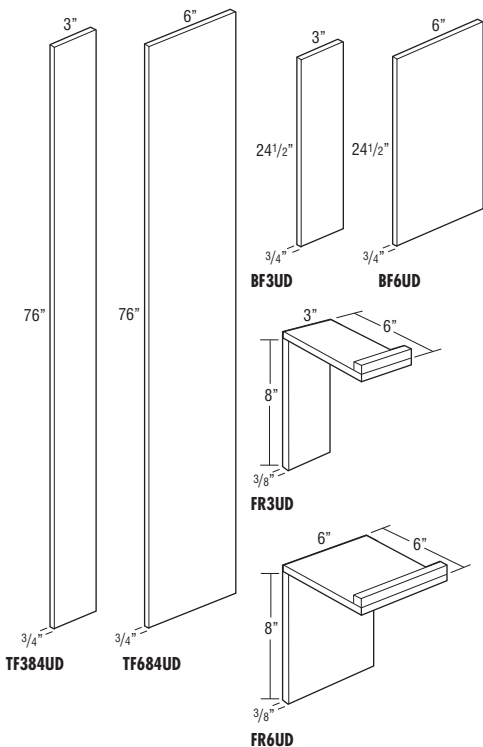

TF384UD

TF684UD

FR6UD



BF3UD	—
TF384UD	—
FR3UD	—
BF6UD	—
TF684UD	—
FR6UD	—

- FR3UD and FR6UD are 3/8" thick, Natural Maple laminated furniture board, used to create a toe kick appearance when used with fillers.

### MODIFICATIONS

No modifications available for these products.

### Finish Techniques

Distressing	Heirlooming
•▲	

▲Not available on FR3UD and FR6UD

### Species Availability (Wood)

Alder	Rustic Alder	Cherry	Hickory	Maple	Oak
•*	•*	•*	•*	•*	•*

\*FR3UD and FR6UD only available in Natural Maple laminate

### Species Availability (All Laminates)

High Glass box color	Horiz. Grain on Maple box color	Vert. Grain on Maple box color	Vert. Grain on Cherry box color	Vert. Grain on Hickory box color	Vert. Grain on Oak box color	Thermofoil box color

**UNIVERSAL DESIGN VANITY DESK LEG**

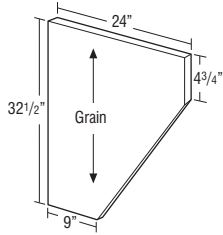

Model	Cubic Feet
VDLUDWD	—



- VDLUDWD in Stains: 3/4" thick veneered furniture board.
- VDLUDWD in Paints: 3/4" thick veneered or solid furniture board.
- All panels are finished two sides and front edge.

MODIFICATIONS
No modifications available for these products.

**Finish Techniques**

Distressing	Heirlooming
-------------	-------------

**Species Availability (Wood)**

Alder	Rustic Alder	Cherry	Hickory	Maple	Oak
•	•	•	•	•	•

**Species Availability (All Laminates)**

High Gloss	Horiz. Grain on Maple	Vert. Grain on Maple	Vert. Grain on Cherry	Vert. Grain on Hickory	Vert. Grain on Oak	Thermofoil
box color	box color	box color	box color	box color	box color	box color

**UNIVERSAL DESIGN TOEBOARD**

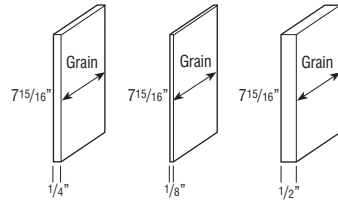

TB8UDWD14    TB8UDLAM18    TB8UDLAM12



Model	Cubic Feet
TB8UDWD14	—

Model	Cubic Feet
TB8UDLAM18	—

Model	Cubic Feet
TB8UDLAM12	—

- TB8UDWD14 in Stains: 1/4" thick veneered furniture board, one 8" section.
- TB8UDWD14 in Paints: 1/4" thick veneered or solid furniture board, one 8" section.
- TB8UDLAM18 is 1/8" laminated furniture board (White only).
- TB8UDLAM12 is 1/2" laminated furniture board (White only).

MODIFICATIONS
No modifications available for these products.

**Finish Techniques**

Distressing	Heirlooming
-------------	-------------

**Species Availability (Wood)**

Alder	Rustic Alder	Cherry	Hickory	Maple	Oak
•*	•*	•*	•*	•*	•*

\*Laminate panels only available in White

**Species Availability (All Laminates)**

High Gloss	Horiz. Grain on Maple	Vert. Grain on Maple	Vert. Grain on Cherry	Vert. Grain on Hickory	Vert. Grain on Oak	Thermofoil
box color	box color	box color	box color	box color	box color	box color

# Diamond<sup>®</sup>

## DISTINCTION™ SERIES

### TALL CABINET NOMENCLATURE

Cabinet nomenclature with AH represents upper sections with doors that align with 24" or 27" high cabinets.

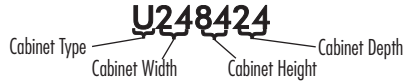

### NOTE:

Any included shelves in tall cabinets are packaged separately.

### MODIFICATIONS GRID KEY

- Available
- STD Standard on these cabinets
- L x G I x Logix<sup>®</sup> Organization Cabinet

### CUSTOM MODIFICATIONS

Mod.	Description	Mod.	Description	Mod.	Description
ACS	Appliance Cut-out, Single	EXBKL	End Extended Back - Left	FTKfV	Flush Toekick Furniture
ADDTK	Add Toekick	EXBKR	End Extended Back - Right	ID	Increased Depth
AUTHL	Authentic End - Left	EXL	Extended Stile - Left	INVFRM	Inverted Frame
AUTHR	Authentic End - Right	EXR	Extended Stile - Right	MIP	Matching Interior Plywood
CBO	Cabinet Box Only	FB	Finished Ends	RD	Reduced Depth
CCO	Cabinet Case Only	FFDL	Face Frame and Door on End - Left	RECTKL	Recessed Toekick - Left
CFNTO	Cabinet Front Only	FFDR	Face Frame and Door on End - Right	RECTKR	Recessed Toekick - Right
CFRMO	Cabinet Frame Only	FFEB	Face Frame Finished Plywood Ends	RT	Installed Roll Tray
CND	Cabinet with No Door, with Drawer	FTK	Flush Toekick	TD	Tray Dividers
DRT	Deep Roll Tray	FTKAV	Flush Toekick Arch	TKP	Loose Toekick
DRWTK	Toekick Drawer			VTK	Void Toekick
				WLI	White Laminate Interior

### CONSTRUCTION UPGRADES

Mod.	Description
APC	All-plywood Construction
ET	EasyTrax™
PE	Plywood Ends

### DOOR OPTIONS

Mod.	Description
CG.TOP	Cut-For-glass Doors
DPSRR	Door Panel - Solid Reverse Raised
MFO	Modified Full Overlay

### UTILITY, 84", 87", 90", 93", or 96" TALL, 12" DEEP

9", 12", 15", 18", 21", or 24"

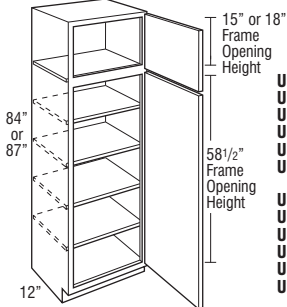

- U98412 L or R
- U128412 L or R
- U158412 L or R
- U188412 L or R
- U218412 L or R
- U248412 L or R
- U98712 L or R
- U128712 L or R
- U158712 L or R
- U188712 L or R
- U218712 L or R
- U248712 L or R

24", 27", 30", 33", or 36"

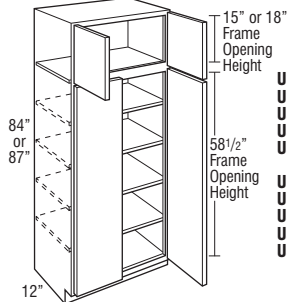

- U248412
- U278412
- U308412
- U338412
- U368412
- U248712
- U278712
- U308712
- U338712
- U368712

Model	Cubic Feet	Model	Cubic Feet
U98412 L or R	7.5	U98712 L or R	7.8
U128412 L or R	9.7	U128712 L or R	10.0
U158412 L or R	11.8	U158712 L or R	12.3
U188412 L or R	14.0	U188712 L or R	14.5
U218412 L or R	16.1	U218712 L or R	16.7
U248412 L or R	18.3	U248712 L or R	18.9
U248412	18.3	U248712	18.9
U278412	20.4	U278712	21.2
U308412	22.6	U308712	23.4
U338412	24.8	U338712	25.6
U368412	26.9	U368712	27.8

- Utility cabinets with depths of 12" or less must be installed to wall studs or onto the end of another tall cabinet.
- Depth can be reduced to a minimum of 6". For depths of 6"-8", cabinet will not include toekick/pedestal.
- Tall non-mitered doors will have two center panels with cross rail.
- Tranter doors greater than 48" high will be two doors doweled together.
- Utility cabinets with depths of 12" or less must be installed to wall studs or onto the end of another tall cabinet.
- Depth can be reduced to a minimum of 6". For depths of 6"-8", cabinet will not include toekick/pedestal.
- Tall non-mitered doors will have two center panels with cross rail.
- Tranter doors greater than 48" high will be two doors doweled together.

### Custom Modifications

ACS	ADDTK	AUTHL	AUTHR	CBO	CCO	CFNTO	CFRMO	CND	DRT	DRWTK	EXBKL	EXBKR	EXL	EXR
		•	•	•	•	•	•				•	•	•	•
	FFDL	FFDR	FPEB	FTK	FTKAV	FTKfV	ID	INVFRM	MIP	RD	RECTKL	RECTKR	RT	TD
•	•	•	•	•	•*			•	•	•	•			•
TKP	VTK	WLI												
•	•	•												

\*Not available on 9" and 12" wide

### Construction Upgrades

APC	ET	PE
•		•

### Door Options

CG.TOP	DPSRR	MFO
•	•	•

**UTILITY, 84", 87", 90", 93", or 96" TALL, 12" DEEP (cont'd)**

9", 12", 15", 18", 21", or 24"

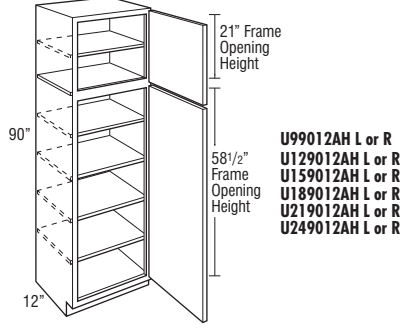

24", 27", 30", 33", or 36"

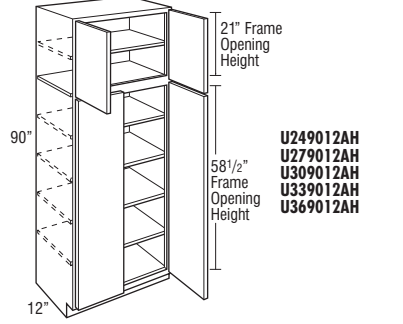

Model	Cubic Feet
<b>U99012AH L or R</b>	8.1
<b>U129012AH L or R</b>	10.4
<b>U159012AH L or R</b>	12.7
<b>U189012AH L or R</b>	15.0
<b>U219012AH L or R</b>	17.3
<b>U249012AH L or R</b>	19.6
<b>U249012AH</b>	19.6
<b>U279012AH</b>	21.9
<b>U309012AH</b>	24.2
<b>U339012AH</b>	26.5
<b>U369012AH</b>	28.8

- AH represents upper section alignment with doors on 24" or 27" high cabinets.
- Utility cabinets with depths of 12" or less must be installed to wall studs or onto the end of another tall cabinet.
- Depth can be reduced to a minimum of 6". For depths of 6"-8", cabinet will not include toekick/pedestal.
- Tall non-mitered doors will have two center panels with cross rail.
- Tranter doors greater than 48" high will be two doors doweled together.

**Custom Modifications**

ACS	ADDTK	AUTHL AUTHR	CBO	CCO	CFNTO	CFRMO	CND	DRT	DRWTK	EXBKL EXBKR	EXL EXR
		•	•	•	•	•				•	•
FB	FFDL FFDR	FPEB	FTK	FTKAV FTKRV	ID	INVFRM	MIP	RD	RECTKL RECTKR	RT	TD
•	•	•	•	•*		•	•	•			•
TKP	VTK	WLI									
•	•	•									

\*Not available on 9" and 12" wide

**Construction Upgrades**

APC	ET	PE
•		•

**Door Options**

CG.TOP	DPSRR	MFO
•	•	•

**UTILITY, 84", 87", 90", 93", or 96" TALL, 12" DEEP (cont'd)**

9", 12", 15", 18", 21", or 24"

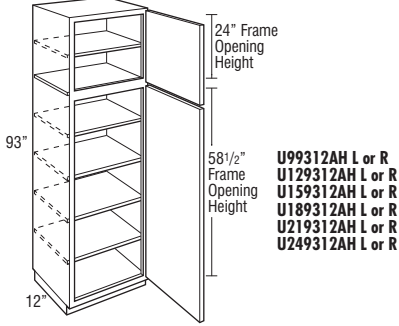

**U99312AH L or R**  
**U129312AH L or R**  
**U159312AH L or R**  
**U189312AH L or R**  
**U219312AH L or R**  
**U249312AH L or R**

24", 27", 30", 33", or 36"

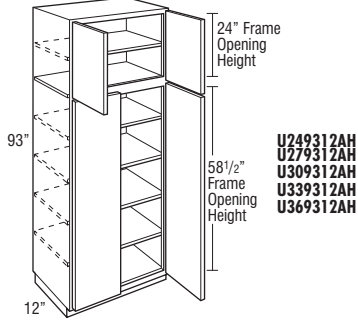

**U249312AH**  
**U279312AH**  
**U309312AH**  
**U339312AH**  
**U369312AH**

9", 12", 15", 18", 21", or 24"

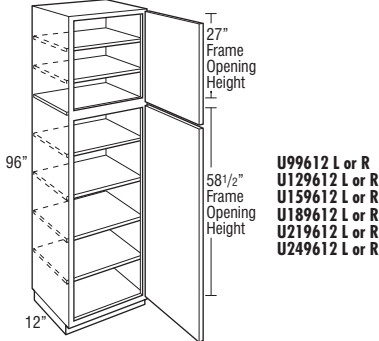

**U99612 L or R**  
**U129612 L or R**  
**U159612 L or R**  
**U189612 L or R**  
**U219612 L or R**  
**U249612 L or R**

24", 27", 30", 33", or 36"

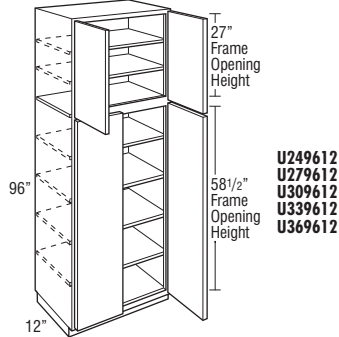

**U249612**  
**U279612**  
**U309612**  
**U339612**  
**U369612**

Model	Cubic Feet	Model	Cubic Feet
U99312AH L or R	8.3	U99612 L or R	8.6
U129312AH L or R	10.7	U129612 L or R	11.0
U159312AH L or R	13.1	U159612 L or R	13.5
U189312AH L or R	15.5	U189612 L or R	16.0
U219312AH L or R	17.8	U219612 L or R	18.4
U249312AH L or R	20.2	U249612 L or R	20.9
U249312AH	20.2	U249612	20.9
U279312AH	22.6	U279612	23.3
U309312AH	25.0	U309612	25.8
U339312AH	27.4	U339612	28.2
U369312AH	29.7	U369612	30.7

- AH represents upper section alignment with doors on 24" or 27" high cabinets.
- Separate pedestal base included but packaged separately on 93" tall. Pedestal is designed to create a Recessed Left or Right Toekick application during field installation, or can be centered. Pedestal must be covered with toeboard material.
- Utility cabinets with depths of 12" or less must be installed to wall studs or onto the end of another tall cabinet.
- Depth can be reduced to a minimum of 6". For depths of 6"-8", cabinet will not include toekick/pedestal.
- Tall non-mitered doors will have two center panels with cross rail.
- Tranter doors greater than 48" high will be two doors doweled together.

- Separate pedestal base included but packaged separately on 96" tall. Pedestal is designed to create a Recessed Left or Right Toekick application during field installation, or can be centered. Pedestal must be covered with toeboard material.
- Utility cabinets with depths of 12" or less must be installed to wall studs or onto the end of another tall cabinet.
- Depth can be reduced to a minimum of 6". For depths of 6"-8", cabinet will not include toekick/pedestal.
- Tall non-mitered doors will have two center panels with cross rail.
- Tranter doors greater than 48" high will be two doors doweled together.

**Custom Modifications**

ACS	ADDTK	AUTHL AUTHR	CBO	CCO	CFNTO	CFRMO	CND	DRT	DRWTK	EXBKL EXBKR	EXL EXR
		•	•	•	•	•				•	•
FB	FFDL FFDR	FPEB	FTK	FTKAV FTKRV	ID	INVFRM	MIP	RD	RECTKL RECTKR	RT	TD
•	•	•				•	•	•	•		•
TKP	VTK	WLI									
		•									

**Construction Upgrades**

APC	ET	PE
•		•

**Door Options**

CG.TOP	DPSRR	MFO
•	•	•

**UTILITY, 84", 87", 90", 93", or 96" TALL, 24" DEEP**

9", 12", 15", 18", 21", or 24"

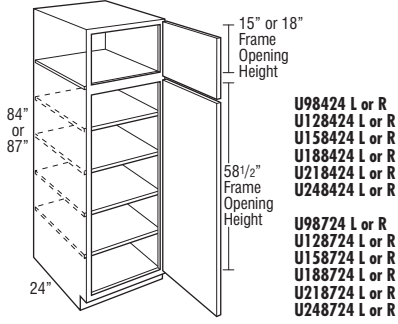

24", 27", 30", 33", or 36"

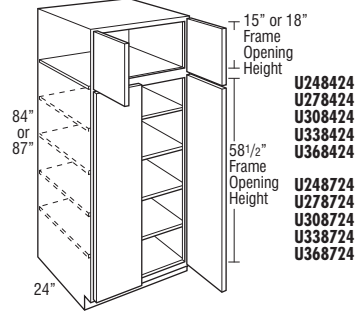

Model	Cubic Feet	Model	Cubic Feet
U98424 L or R	13.8	U98724 L or R	14.3
U128424 L or R	17.7	U128724 L or R	18.3
U158424 L or R	21.6	U158724 L or R	22.4
U188424 L or R	25.6	U188724 L or R	26.5
U218424 L or R	29.5	U218724 L or R	30.5
U248424 L or R	33.4	U248724 L or R	34.6
U248424	33.4	U248724	34.6
U278424	37.4	U278724	38.7
U308424	41.3	U308724	42.8
U338424	45.2	U338724	46.8
U368424	49.2	U368724	50.9

- Depth can be reduced to a minimum of 6". For depths of 6"-8", cabinet will not include toekick/pedestal.
- Tall non-mitered doors will have two center panels with cross rail.
- Tranter doors greater than 48" high will be two doors doweled together.

- Depth can be reduced to a minimum of 6". For depths of 6"-8", cabinet will not include toekick/pedestal.
- Tall non-mitered doors will have two center panels with cross rail.
- Tranter doors greater than 48" high will be two doors doweled together.

**Custom Modifications**

ACS	ADDTK	AUTHL AUTHR	CBO	CCO	CFNTO	CFRMO	CND	DRT	DRWTK	EXBKL EXBKR	EXL EXR
		•	•	•	•	•			•*	•	•
FB	FFDL FFDR	FPEB	FTK	FTKAV FTKRV	ID	INVFRM	MIP	RD	RECTKL RECTKR	RT	TD
•	•	•	•	•*	•	•	•	•	•	•▲	•
TKP	VTK	WLI									
•	•	•									

\*Not available on 9", 12", and 15" wide    \*Not available on 9" and 12" wide    ▲Not available on 9" wide

**Construction Upgrades**

APC	ET	PE
•		•

**Door Options**

CG.TOP	DPSRR	MFO
•	•	•



**UTILITY, 84", 87", 90", 93", or 96" TALL, 24" DEEP (cont'd)**

9", 12", 15", 18", 21", or 24"

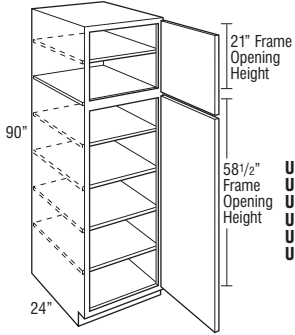

**U99024AH L or R**  
**U129024AH L or R**  
**U159024AH L or R**  
**U189024AH L or R**  
**U219024AH L or R**  
**U249024AH L or R**

24", 27", 30", 33", or 36"

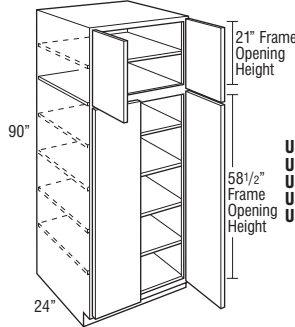

**U249024AH**  
**U279024AH**  
**U309024AH**  
**U339024AH**  
**U369024AH**

Model	Cubic Feet
<b>U99024AH L or R</b>	14.7
<b>U129024AH L or R</b>	18.9
<b>U159024AH L or R</b>	23.2
<b>U189024AH L or R</b>	27.4
<b>U219024AH L or R</b>	31.6
<b>U249024AH L or R</b>	35.8
<b>U249024AH</b>	35.8
<b>U279024AH</b>	40.0
<b>U309024AH</b>	44.2
<b>U339024AH</b>	48.4
<b>U369024AH</b>	52.6

- AH represents upper section alignment with doors on 24" or 27" high cabinets.
- Depth can be reduced to a minimum of 6". For depths of 6"-8", cabinet will not include toekick/pedestal.
- Tall non-mitered doors will have two center panels with cross rail.
- Tranter doors greater than 48" high will be two doors doweled together.

**Custom Modifications**

ACS	ADDTK	AUTHL AUTHR	CBO	CCO	CFNTO	CFRMO	CND	DRT	DRWTK	EXBKL EXBKR	EXL EXR
		•	•	•	•	•			•*	•	•
FB	FFDL FFDR	FPEB	FTK	FTKAV FTKRV	ID	INVRM	MIP	RD	RECTKL RECTKR	RT	TD
•	•	•	•	•*	•	•	•	•	•	•▲	•
TKP	VTK	WLI									
•	•	•									

\*Not available on 9", 12", and 15" wide \*Not available on 9" and 12" wide ▲Not available on 9" wide

**Construction Upgrades**

APC	ET	PE
•		•

**Door Options**

CG.TOP	DPSRR	MFO
•	•	•

**UTILITY, 84", 87", 90", 93", or 96" TALL, 24" DEEP (cont'd)**

9", 12", 15", 18", 21", or 24"

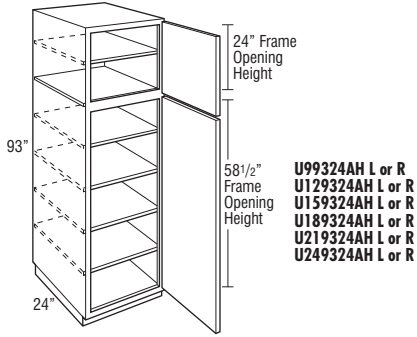

**U99324AH L or R**  
**U129324AH L or R**  
**U159324AH L or R**  
**U189324AH L or R**  
**U219324AH L or R**  
**U249324AH L or R**

24", 27", 30", 33", or 36"

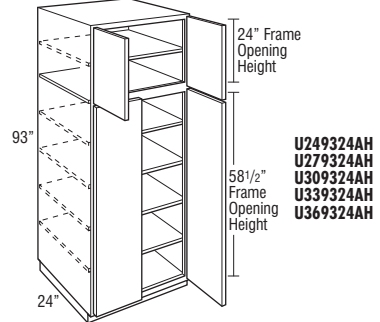

**U249324AH**  
**U279324AH**  
**U309324AH**  
**U339324AH**  
**U369324AH**

9", 12", 15", 18", 21", or 24"

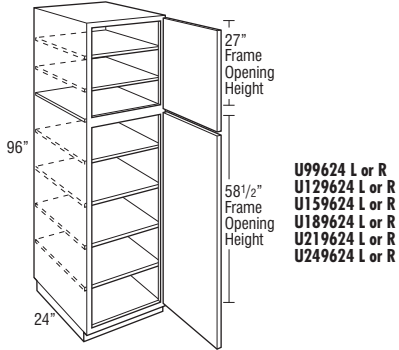

**U99624 L or R**  
**U129624 L or R**  
**U159624 L or R**  
**U189624 L or R**  
**U219624 L or R**  
**U249624 L or R**

24", 27", 30", 33", or 36"

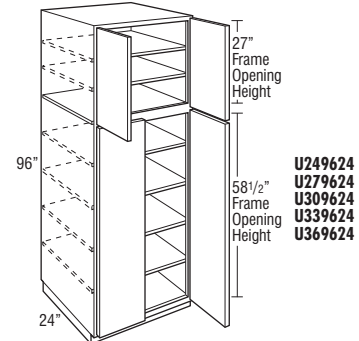

**U249624**  
**U279624**  
**U309624**  
**U339624**  
**U369624**

Model	Cubic Feet
<b>U99324AH L or R</b>	15.2
<b>U129324AH L or R</b>	19.6
<b>U159324AH L or R</b>	23.9
<b>U189324AH L or R</b>	28.3
<b>U219324AH L or R</b>	32.6
<b>U249324AH L or R</b>	37.0
<b>U249324AH</b>	37.0
<b>U279324AH</b>	41.3
<b>U309324AH</b>	45.7
<b>U339324AH</b>	50.0
<b>U369324AH</b>	54.3

Model	Cubic Feet
<b>U99624 L or R</b>	15.7
<b>U129624 L or R</b>	20.2
<b>U159624 L or R</b>	24.7
<b>U189624 L or R</b>	29.2
<b>U219624 L or R</b>	33.6
<b>U249624 L or R</b>	38.1
<b>U249624</b>	38.1
<b>U279624</b>	42.6
<b>U309624</b>	47.1
<b>U339624</b>	51.6
<b>U369624</b>	56.1

- AH represents upper section alignment with doors on 24" or 27" high cabinets.
- Separate pedestal base included but packaged separately on 93" tall. Pedestal is designed to create a Recessed Left or Right Toekick application during field installation, or can be centered. Pedestal must be covered with toeboard material.
- Depth can be reduced to a minimum of 6". For depths of 6"-8", cabinet will not include toekick/pedestal.
- Tall non-mitered doors will have two center panels with cross rail.
- Tranter doors greater than 48" high will be two doors doweled together.

- Separate pedestal base included but packaged separately on 96" tall. Pedestal is designed to create a Recessed Left or Right Toekick application during field installation, or can be centered. Pedestal must be covered with toeboard material.
- Depth can be reduced to a minimum of 6". For depths of 6"-8", cabinet will not include toekick/pedestal.
- Tall non-mitered doors will have two center panels with cross rail.
- Tranter doors greater than 48" high will be two doors doweled together.

**Custom Modifications**

ACS	ADDTK	AUTHL AUTHR	CBO	CCO	CFNTO	CFRMO	CND	DRT	DRWTK	EXBKL EXBKR	EXL EXR
		•	•	•	•	•				•	•
FB	FFDL FFDR	FPEB	FTK	FTKAV FTKRV	ID	INVFRM	MIP	RD	RECTKL RECTKR	RT	TD
•	•	•			•	•	•	•	•	•*	•
TKP	VTK	WLI									
		•									

\*Not available on 9" wide

**Construction Upgrades**

APC	ET	PE
•		•

**Door Options**

CG.TOP	DPSRR	MFO
•	•	•

**UTILITY with ROLL TRAYS, 84", 87", 90", 93", or 96" TALL, 24" DEEP**

12", 15", 18", 21", or 24"

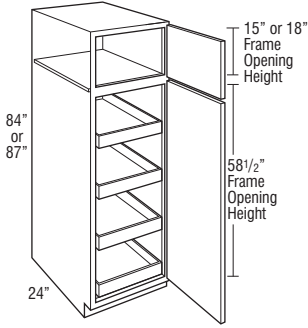

- U128424RT L or R
- U158424RT L or R
- U188424RT L or R
- U218424RT L or R
- U248424RT L or R
- U128724RT L or R
- U158724RT L or R
- U188724RT L or R
- U218724RT L or R
- U248724RT L or R

24", 27", 30", 33", or 36"

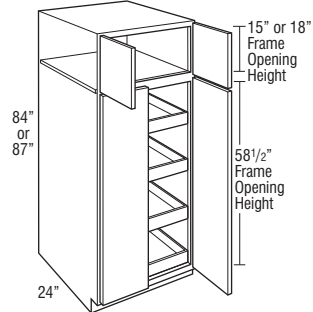

- U248424RT
- U278424RT
- U308424RT
- U338424RT
- U368424RT
- U248724RT
- U278724RT
- U308724RT
- U338724RT
- U368724RT

Model	Cubic Feet	Model	Cubic Feet
U128424RT L or R	16.2	U128724RT L or R	18.9
U158424RT L or R	21.6	U158724RT L or R	22.4
U188424RT L or R	25.6	U188724RT L or R	26.5
U218424RT L or R	29.5	U218724RT L or R	30.5
U248424RT L or R	33.4	U248724RT L or R	34.6
U248424RT	33.4	U248724RT	34.6
U278424RT	37.4	U278724RT	38.7
U308424RT	41.3	U308724RT	42.8
U338424RT	45.2	U338724RT	46.8
U368424RT	49.2	U368724RT	50.9

- Four roll trays are included, installed in cabinet.
- Depth can be reduced to a minimum of 12".
- Tall non-mitered doors will have two center panels with cross rail.
- Tranter doors greater than 48" high will be two doors doweled together.

- Four roll trays are included, installed in cabinet.
- Depth can be reduced to a minimum of 12".
- Tall non-mitered doors will have two center panels with cross rail.
- Tranter doors greater than 48" high will be two doors doweled together.

**Custom Modifications**

ACS	ADDTK	AUTHL AUTHR	CBO	CCO	CFNTO	CFRMO	CND	DRT	DRWTK	EXBKL EXBKR	EXL EXR
		•	•	•	•	•		•	•*	•	•
FB	FFDL FFDR	FPEB	FTK	FTKAV FTKRV	ID	INVFRM	MIP	RD	RECTKL RECTKR	RT	TD
•		•	•	•			•	•	•		•
TKP	VTK	WLI									
•	•	•									

\*Not available on 12" and 15" wide

**Construction Upgrades**

APC	ET	PE
•	•	•

**Door Options**

CG.TOP	DPSRR	MFO
•	•	•

**UTILITY with ROLL TRAYS, 84", 87", 90", 93", or 96" TALL, 24" DEEP (cont'd)**

12", 15", 18", 21", or 24"

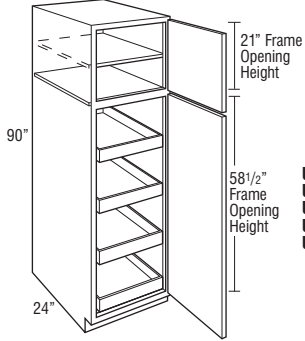

**U129024RTAH L or R**  
**U159024RTAH L or R**  
**U189024RTAH L or R**  
**U219024RTAH L or R**  
**U249024RTAH L or R**

24", 27", 30", 33", or 36"

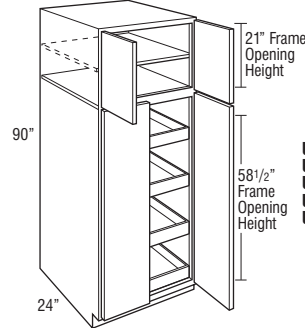

**U249024RTAH**  
**U279024RTAH**  
**U309024RTAH**  
**U339024RTAH**  
**U369024RTAH**

Model	Cubic Feet
<b>U129024RTAH L or R</b>	17.3
<b>U159024RTAH L or R</b>	23.2
<b>U189024RTAH L or R</b>	27.4
<b>U219024RTAH L or R</b>	31.6
<b>U249024RTAH L or R</b>	35.8
<b>U249024RTAH</b>	35.8
<b>U279024RTAH</b>	40.0
<b>U309024RTAH</b>	44.2
<b>U339024RTAH</b>	48.4
<b>U369024RTAH</b>	52.6

- AH represents upper section alignment with doors on 24" or 27" high cabinets.
- Four roll trays are included, installed in cabinet.
- Depth can be reduced to a minimum of 12".
- Tall non-mitered doors will have two center panels with cross rail.
- Tranter doors greater than 48" high will be two doors doweled together.

**Custom Modifications**

ACS	ADDTK	AUTHL AUTHR	CBO	CCO	CFNTO	CFRMO	CND	DRT	DRWTK	EXBKL EXBKR	EXL EXR
		•	•	•	•	•		•	•*	•	•
FB	FFDL FFDR	FPEB	FTK	FTKAV FTKRV	ID	INVFRM	MIP	RD	RECTKL RECTKR	RT	TD
•		•	•	•			•	•	•		•
TKP	VTK	WLI									
•	•	•									

\*Not available on 12" and 15" wide

**Construction Upgrades**

APC	ET	PE
•	•	•

**Door Options**

CG.TOP	DPSRR	MFO
•	•	•

**UTILITY with ROLL TRAYS, 84", 87", 90", 93", or 96" TALL, 24" DEEP (cont'd)**

12", 15", 18", 21", or 24"

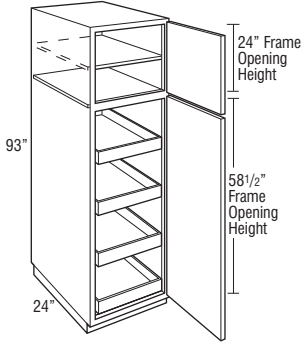

**U129324RTAH L or R**  
**U159324RTAH L or R**  
**U189324RTAH L or R**  
**U219324RTAH L or R**  
**U249324RTAH L or R**

24", 27", 30", 33", or 36"

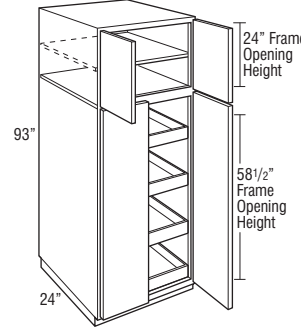

**U249324RTAH**  
**U279324RTAH**  
**U309324RTAH**  
**U339324RTAH**  
**U369324RTAH**

12", 15", 18", 21", or 24"

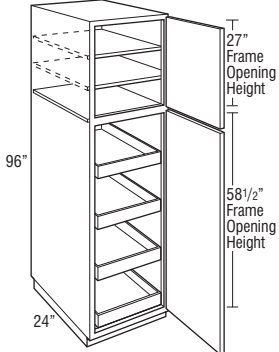

**U129624RT L or R**  
**U159624RT L or R**  
**U189624RT L or R**  
**U219624RT L or R**  
**U249624RT L or R**

24", 27", 30", 33", or 36"

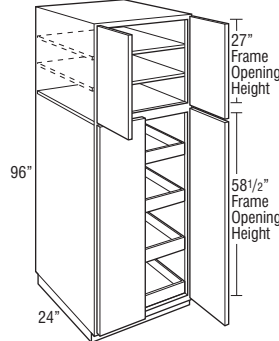

**U249624RT**  
**U279624RT**  
**U309624RT**  
**U339624RT**  
**U369624RT**

Model	Cubic Feet	Model	Cubic Feet
U129324RTAH L or R	19.2	U129624RT L or R	18.5
U159324RTAH L or R	23.9	U159624RT L or R	24.7
U189324RTAH L or R	28.3	U189624RT L or R	29.2
U219324RTAH L or R	32.6	U219624RT L or R	33.6
U249324RTAH L or R	37.0	U249624RT L or R	38.1
U249324RTAH	37.0	U249624RT	38.1
U279324RTAH	41.3	U279624RT	42.6
U309324RTAH	45.7	U309624RT	47.1
U339324RTAH	50.0	U339624RT	51.6
U369324RTAH	54.3	U369624RT	56.1

- AH represents upper section alignment with doors on 24" or 27" high cabinets.
- Separate pedestal base included but packaged separately on 93" tall. Pedestal is designed to create a Recessed Left or Right Toekick application during field installation, or can be centered. Pedestal must be covered with toeboard material.
- Four roll trays are included, installed in cabinet.
- Depth can be reduced to a minimum of 12".
- Tall non-mitered doors will have two center panels with cross rail.
- Tranter doors greater than 48" high will be two doors doveled together.

- Separate pedestal base included but packaged separately on 96" tall. Pedestal is designed to create a Recessed Left or Right Toekick application during field installation, or can be centered. Pedestal must be covered with toeboard material.
- Four roll trays are included, installed in cabinet.
- Depth can be reduced to a minimum of 12".
- Tall non-mitered doors will have two center panels with cross rail.
- Tranter doors greater than 48" high will be two doors doveled together.

**Custom Modifications**

ACS	ADDTK	AUTHL	AUTHR	CBO	CCO	CFNTO	CFRMO	CND	DRT	DRWTK	EXBKL	EXBKR	EXL	EXR
		•		•	•	•	•		•		•		•	•
FB	FFDL	FFDR	FPEB	FTK	FTKAV	FTKRV	ID	INVRM	MIP	RD	RECTKL	RECTKR	RT	TD
•			•						•	•	•*			•
TKP	VTK	WLI												
			•											

\*Not available on 12" wide

**Construction Upgrades**

APC	ET	PE
•	•	•

**Door Options**

CG.TOP	DPSRR	MFO
•	•	•

**UTILITY EASY ACCESS, 84", 87", 90", 93", or 96" TALL, 12" DEEP** L O G I X

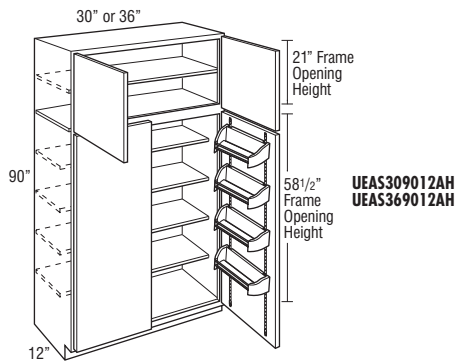
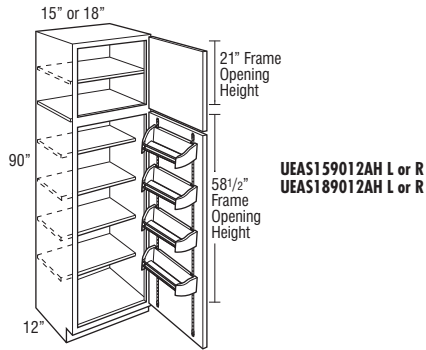
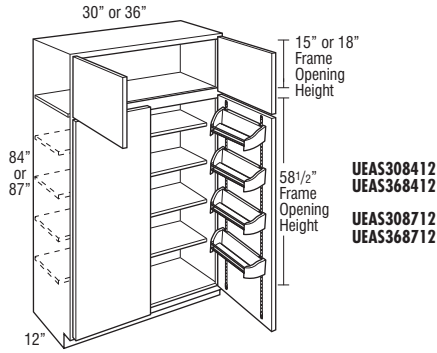
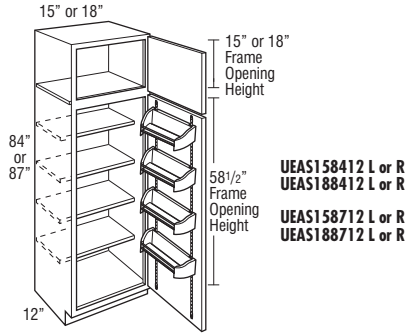

Model	Cubic Feet
UEAS158412 L or R	11.8
UEAS188412 L or R	14.0
UEAS158712 L or R	12.3
UEAS188712 L or R	14.5
UEAS308412	22.6
UEAS368412	26.9
UEAS308712	23.4
UEAS368712	27.8

- Four chrome baskets featuring rail system for adjustability on each lower door.
- Four 6 1/2" reduced depth adjustable shelves are included.
- Utility cabinets with depths of 12" or less must be installed to wall studs or onto the end of another tall cabinet.
- Depth can be reduced to a minimum of 10".
- Tall non-mitered doors will have two center panels with cross rail.
- Tranter doors greater than 48" high will be two doors doweled together.

Model	Cubic Feet
UEAS159012AH L or R	12.7
UEAS189012AH L or R	15.0
UEAS309012AH	24.2
UEAS369012AH	28.8

- AH represents upper section alignment with doors on 24" or 27" high cabinets.
- Four chrome baskets featuring rail system for adjustability on each lower door.
- Four 6 1/2" reduced depth adjustable shelves and one full depth adjustable shelf are included.
- Utility cabinets with depths of 12" or less must be installed to wall studs or onto the end of another tall cabinet.
- Depth can be reduced to a minimum of 10".
- Tall non-mitered doors will have two center panels with cross rail.
- Tranter doors greater than 48" high will be two doors doweled together.

**Custom Modifications**

ACS	ADDTK	AUTHL AUTHR	CBO	CCO	CFNTO	CFRMO	CND	DRT	DRWTK	EXBKL EXBKR	EXL EXR
		•	•	•	•	•				•	•
FB	FFDL FFDR	FPEB	FTK	FTKAV FTKFV	ID	INVFRM	MIP	RD	RECTKL RECTKR	RT	TD
•		•	•	•			•	•	•		•
TKP	VTK	WLI									
•	•	•									

**Construction Upgrades**

APC	ET	PE
•		•

**Door Options**

CG.TOP	DPSRR	MFO
•	•	•

**UTILITY EASY ACCESS, 84", 87", 90", 93", or 96" TALL, 12" DEEP (cont'd)** L G I X

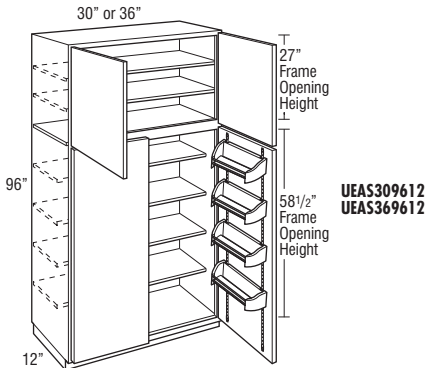
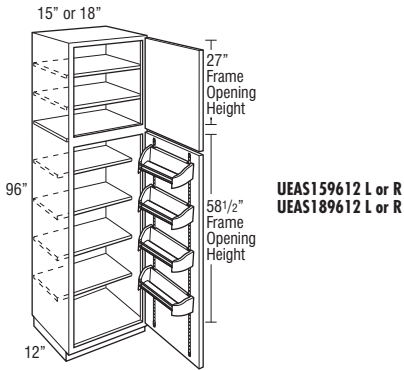
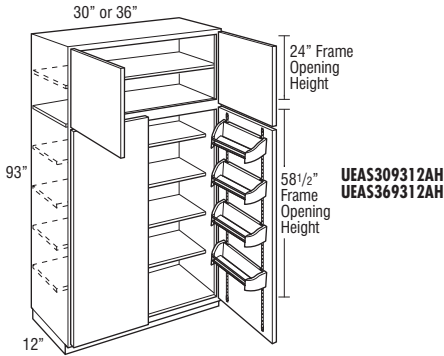
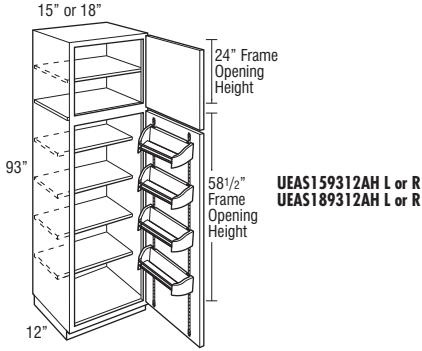

Model	Cubic Feet	Model	Cubic Feet
UEAS159312AH L or R	13.1	UEAS159612 L or R	13.5
UEAS189312AH L or R	15.5	UEAS189612 L or R	16.0
UEAS309312AH	25.0	UEAS309612	25.8
UEAS369312AH	29.7	UEAS369612	30.7

- AH represents upper section alignment with doors on 24" or 27" high cabinets.
- Four chrome baskets featuring rail system for adjustability on each lower door.
- Separate pedestal base included but packaged separately on 93" tall. Pedestal is designed to create a Recessed Left or Right Toekick application during field installation, or can be centered. Pedestal must be covered with toeboard material.
- Four 6 1/2" reduced depth adjustable shelves are included.
- Utility cabinets with depths of 12" or less must be installed to wall studs or onto the end of another tall cabinet.
- Depth can be reduced to a minimum of 10".
- Tall non-mitered doors will have two center panels with cross rail.
- Tranter doors greater than 48" high will be two doors doveled together.

- Four chrome baskets featuring rail system for adjustability on each lower door.
- Separate pedestal base included but packaged separately on 96" tall. Pedestal is designed to create a Recessed Left or Right Toekick application during field installation, or can be centered. Pedestal must be covered with toeboard material.
- Four 6 1/2" reduced depth adjustable shelves and two full depth adjustable shelves are included.
- Utility cabinets with depths of 12" or less must be installed to wall studs or onto the end of another tall cabinet.
- Depth can be reduced to a minimum of 10".
- Tall non-mitered doors will have two center panels with cross rail.
- Tranter doors greater than 48" high will be two doors doveled together.

**Custom Modifications**

ACS	ADDTK	AUTHL AUTHR	CBO	CCO	CFNTO	CFRMO	CND	DRT	DRWTK	EXBKL EXBKR	EXL EXR
		•	•	•	•	•				•	•
FB	FFDL FFDR	FPEB	FTK	FTKAV FTKFV	ID	INVRM	MIP	RD	RECTKL RECTKR	RT	TD
•		•					•	•	•		•
TKP	VTK	WLI									
•		•									

**Construction Upgrades**

APC	ET	PE
•		•

**Door Options**

CG.TOP	DPSRR	MFO
•	•	•

**UTILITY EASY ACCESS, 84", 87", 90", 93", or 96" TALL, 24" DEEP** LOGIX

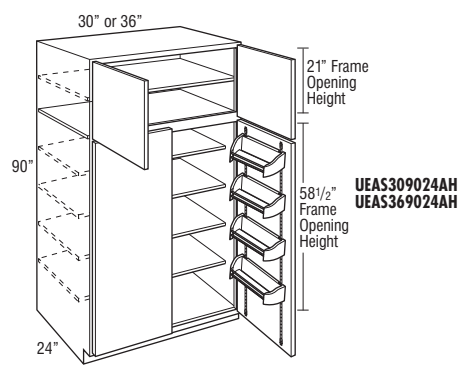
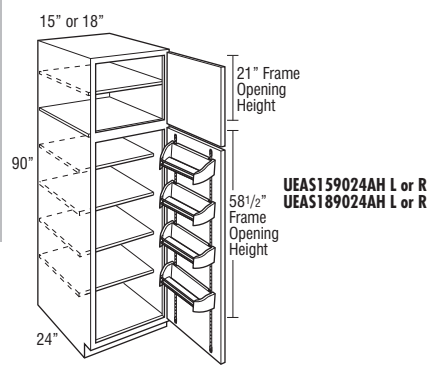
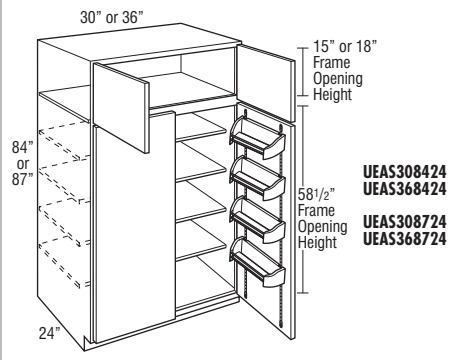
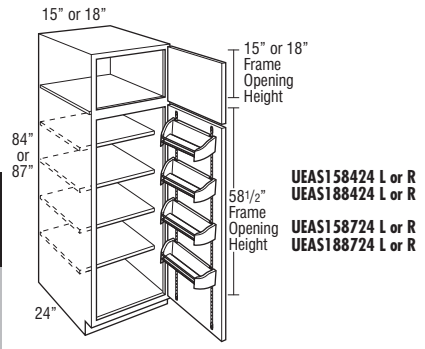

Model	Cubic Feet
<b>UEAS158424 L or R</b>	21.6
<b>UEAS188424 L or R</b>	25.6
<b>UEAS158724 L or R</b>	22.4
<b>UEAS188724 L or R</b>	26.5
<b>UEAS308424</b>	41.3
<b>UEAS368424</b>	49.2
<b>UEAS308724</b>	42.8
<b>UEAS368724</b>	50.9

- Four chrome baskets featuring rail system for adjustability on each lower door.
- Four 18 1/2" reduced depth adjustable shelves are included.
- Depth can be reduced to a minimum of 10".
- Tall non-mitered doors will have two center panels with cross rail.
- Tranter doors greater than 48" high will be two doors doweled together.

Model	Cubic Feet
<b>UEAS159024AH L or R</b>	23.2
<b>UEAS189024AH L or R</b>	27.4
<b>UEAS309024AH</b>	44.2
<b>UEAS369024AH</b>	52.6

- AH represents upper section alignment with doors on 24" or 27" high cabinets.
- Four chrome baskets featuring rail system for adjustability on each lower door.
- Four 18 1/2" reduced depth adjustable shelves and one full depth adjustable shelf are included.
- Utility cabinets with depths of 12" or less must be installed to wall studs or onto the end of another tall cabinet.
- Depth can be reduced to a minimum of 10".
- Tall non-mitered doors will have two center panels with cross rail.
- Tranter doors greater than 48" high will be two doors doweled together.

**Custom Modifications**

	ACS	ADDTK	AUTHL AUTHR	CBO	CCO	CFNTO	CFRMO	CND	DRT	DRWTK	EXBKL EXBKR	EXL EXR
			•	•	•	•	•			•*	•	•
		FFDL FFDR	FPEB	FTK	FTKAV FTKRV	ID	INVFRM	MIP	RD	RECTKL RECTKR	RT	TD
	•	•	•	•	•			•	•	•		•
	TKP	VTK	WLI									
	•	•	•									

\*Not available on 15" wide

**Construction Upgrades**

APC	ET	PE
•		•

**Door Options**

CG.TOP	DPSRR	MFO
•	•	•



**UTILITY EASY ACCESS, 84", 87", 90", 93", or 96" TALL, 24" DEEP (cont'd)** L G I X

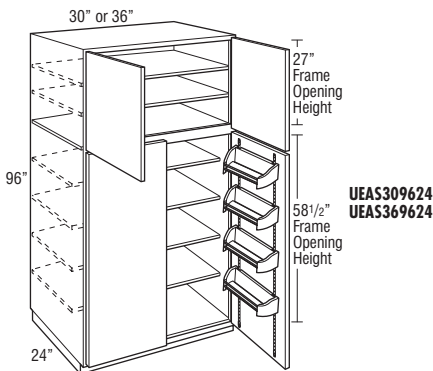
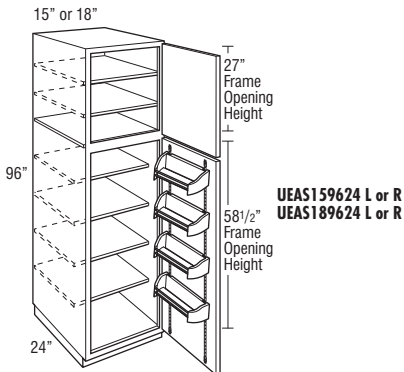
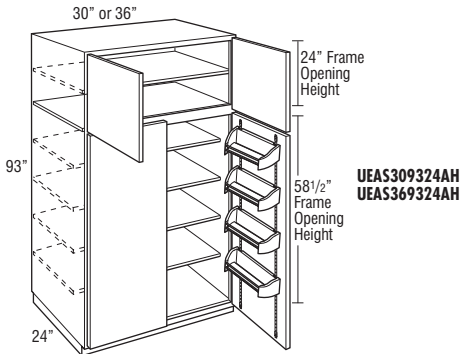
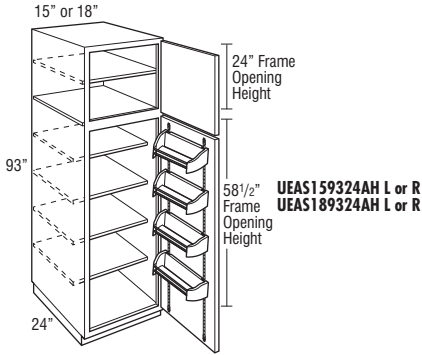

Model	Cubic Feet
<b>UEAS159324AH L or R</b>	23.9
<b>UEAS189324AH L or R</b>	28.3
<b>UEAS309324AH</b>	45.7
<b>UEAS369324AH</b>	54.3

- AH represents upper section alignment with doors on 24" or 27" high cabinets.
- Four chrome baskets featuring rail system for adjustability on each lower door.
- Separate pedestal base included but packaged separately on 93" tall. Pedestal is designed to create a Recessed Left or Right Toekick application during field installation, or can be centered. Pedestal must be covered with toeboard material.
- Four 18 1/2" reduced depth adjustable shelves and one full depth adjustable shelf are included.
- Utility cabinets with depths of 12" or less must be installed to wall studs or onto the end of another tall cabinet.
- Depth can be reduced to a minimum of 10".
- Tall non-mitered doors will have two center panels with cross rail.
- Tranter doors greater than 48" high will be two doors doveled together.

Model	Cubic Feet
<b>UEAS159624 L or R</b>	24.7
<b>UEAS189624 L or R</b>	29.2
<b>UEAS309624</b>	47.1
<b>UEAS369624</b>	56.1

- Four chrome baskets featuring rail system for adjustability on each lower door.
- Separate pedestal base included but packaged separately on 96" tall. Pedestal is designed to create a Recessed Left or Right Toekick application during field installation, or can be centered. Pedestal must be covered with toeboard material.
- Four 18 1/2" reduced depth adjustable shelves and two full depth adjustable shelves are included.
- Utility cabinets with depths of 12" or less must be installed to wall studs or onto the end of another tall cabinet.
- Depth can be reduced to a minimum of 10".
- Tall non-mitered doors will have two center panels with cross rail.
- Tranter doors greater than 48" high will be two doors doveled together.

**Custom Modifications**

ACS	ADDTK	AUTHL AUTHR	CBO	CCO	CFNTO	CFRMO	CND	DRT	DRWTK	EXBKL EXBKR	EXL EXR
		•	•	•	•	•				•	•
FB	FFDL FFDR	FPEB	FTK	FTKAV FTKFV	ID	INVRM	MIP	RD	RECTKL RECTKR	RT	TD
•		•					•	•	•		•
TKP	VTK	WLI									
		•									

**Construction Upgrades**

APC	ET	PE
•		•

**Door Options**

CG.TOP	DPSRR	MFO
•	•	•

**UTILITY ORGANIZER CABINET, 84", 87", 90", 93", or 96" TALL, 6" DEEP, 24" WIDE**

L O G I X

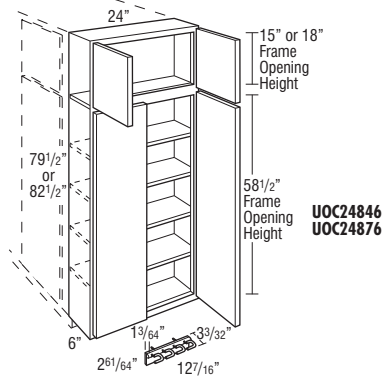

**UOC24846**  
**UOC24876**

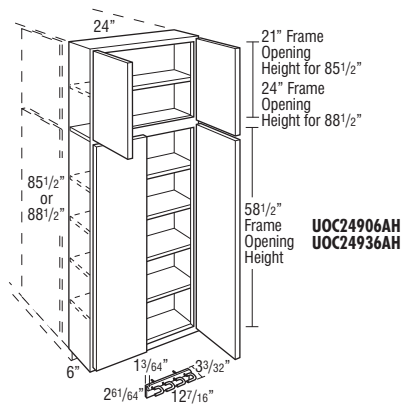

**UOC24906AH**  
**UOC24936AH**

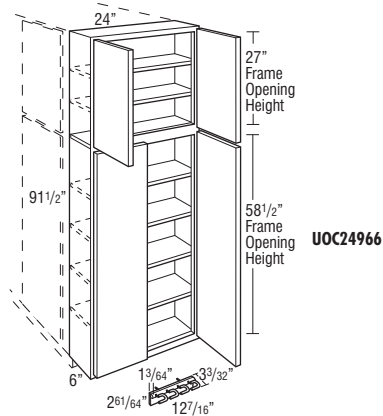

**UOC24966**

Model	Cubic Feet
<b>UOC24846</b>	10.7
<ul style="list-style-type: none"> <li>Includes four adjustable shelves and broom clip packaged separately (not installed).</li> <li>Designed to be installed onto an adjacent 24" deep tall cabinet.</li> <li>For proper installation, adjacent cabinet must have FPFB or 1/4" skin applied.</li> <li>6" overlay fillers can be used on the side to add a decorative touch (Full overlay door styles only).</li> <li>Utility cabinets with depths of 12" or less must be installed to wall studs or onto the end of another tall cabinet.</li> <li>Does not include toeboard or pedestal.</li> <li>Tall non-mitered doors will have two center panels with cross rail.</li> <li>Tranter doors greater than 48" high will be two doors doveled together.</li> </ul>	

Model	Cubic Feet
<b>UOC24876</b>	11.1
<ul style="list-style-type: none"> <li>Includes four adjustable shelves and broom clip packaged separately (not installed).</li> <li>Designed to be installed onto an adjacent 24" deep tall cabinet.</li> <li>For proper installation, adjacent cabinet must have FPFB or 1/4" skin applied.</li> <li>6" overlay fillers can be used on the side to add a decorative touch (Full overlay door styles only).</li> <li>Utility cabinets with depths of 12" or less must be installed to wall studs or onto the end of another tall cabinet.</li> <li>Does not include toeboard or pedestal.</li> <li>Tall non-mitered doors will have two center panels with cross rail.</li> <li>Tranter doors greater than 48" high will be two doors doveled together.</li> </ul>	

Model	Cubic Feet
<b>UOC24906AH</b>	11.5
<ul style="list-style-type: none"> <li>AH represents upper section alignment with doors on 24" or 27" high cabinets.</li> <li>Includes five adjustable shelves and broom clip packaged separately (not installed).</li> <li>Designed to be installed onto an adjacent 24" deep tall cabinet.</li> <li>For proper installation, adjacent cabinet must have FPFB or 1/4" skin applied.</li> <li>6" overlay fillers can be used on the side to add a decorative touch (Full overlay door styles only).</li> <li>Utility cabinets with depths of 12" or less must be installed to wall studs or onto the end of another tall cabinet.</li> <li>Does not include toeboard or pedestal.</li> <li>Tall non-mitered doors will have two center panels with cross rail.</li> <li>Tranter doors greater than 48" high will be two doors doveled together.</li> </ul>	

Model	Cubic Feet
<b>UOC24936AH</b>	11.9
<ul style="list-style-type: none"> <li>AH represents upper section alignment with doors on 24" or 27" high cabinets.</li> <li>Includes five adjustable shelves and broom clip packaged separately (not installed).</li> <li>Designed to be installed onto an adjacent 24" deep tall cabinet.</li> <li>For proper installation, adjacent cabinet must have FPFB or 1/4" skin applied.</li> <li>6" overlay fillers can be used on the side to add a decorative touch (Full overlay door styles only).</li> <li>Utility cabinets with depths of 12" or less must be installed to wall studs or onto the end of another tall cabinet.</li> <li>Does not include toeboard or pedestal.</li> <li>Tall non-mitered doors will have two center panels with cross rail.</li> <li>Tranter doors greater than 48" high will be two doors doveled together.</li> </ul>	

Model	Cubic Feet
<b>UOC24966</b>	12.2
<ul style="list-style-type: none"> <li>Includes six adjustable shelves and broom clip packaged separately (not installed).</li> <li>Designed to be installed onto an adjacent 24" deep tall cabinet.</li> <li>For proper installation, adjacent cabinet must have FPFB or 1/4" skin applied.</li> <li>6" overlay fillers can be used on the side to add a decorative touch (Full overlay door styles only).</li> <li>Utility cabinets with depths of 12" or less must be installed to wall studs or onto the end of another tall cabinet.</li> <li>Does not include toeboard or pedestal.</li> <li>Tall non-mitered doors will have two center panels with cross rail.</li> <li>Tranter doors greater than 48" high will be two doors doveled together.</li> </ul>	

**Custom Modifications**

ACS	ADDTK	AUTHL AUTHR	CBO	CCO	CFNTO	CFRMO	CND	DRT	DRWTK	EXBKL EXBKR	EXL EXR
			•	•	•	•					
FB	FFDL FFDR	FPEB	FTK	FTKAV FTKRV	ID	INVERM	MIP	RD	RECTKL RECTKR	RT	TD
TKP	VTK	WLI				•	•				
		•									

**Construction Upgrades**

APC	ET	PE
•		

**Door Options**

CG.TOP	DPSRR	MFO
•	•	•

**UTILITY ORGANIZER DROP ZONE CABINET, 84", 87", 90", 93", or 96" HIGH, 9" DEEP, 24" WIDE**

L G I X

Model	Cubic Feet
UOCDZ24849AEL	14.5
UOCDZ24849AER	14.5
UOCDZ24879AEL	15.0
UOCDZ24879AER	15.0
UOCDZ24909AHAL	15.5
UOCDZ24909AHAR	15.5
UOCDZ24939AHAL	16.0
UOCDZ24939AHAR	16.0
UOCDZ24969AEL	16.5
UOCDZ24969AER	16.5

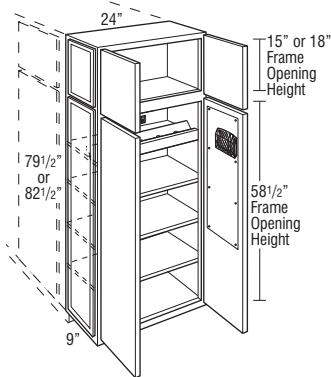
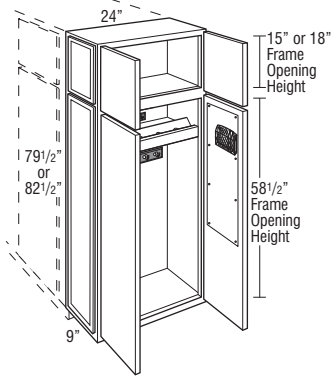

UOCDZ24849AEL  
UOCDZ24849AER  
  
UOCDZ24879AEL  
UOCDZ24879AER

- AH represents upper section alignment with doors on 24" or 27" high cabinets.
- Features magnetic whiteboards on back of lower doors, one magnetic black mesh pencil holder, charging station with power strip, black plastic grommet for power cord, key hooks, and coat hooks. Accessories are field installed.
- Charging station functions as an adjustable shelf, features five cord cut-out areas and includes a UL listed power strip with three standard 110-volt plug-ins and one USB charging port.
- One adjustable shelf in upper section on 90" and 93", two adjustable shelves for 96", and three adjustable shelves in lower section.
- Authentic Ends are standard on one side. Specify AEL model for installation on the right side of a tall cabinet. Specify AER model for installation on the left side of a tall cabinet. Opposite end panel will feature FPEB construction (if decorative doors are desired on both sides of cabinet, order No Hinge Route doors for a Tall Pantry Pull-out).
- Designed to be installed onto an adjacent 24" deep tall cabinet.
- For proper installation, adjacent cabinet must have FPEB or 1/4" skin applied.
- Utility cabinets with depths of 12" or less must be installed to wall studs or onto the end of another tall cabinet.
- Does not include toeboard or pedestal.
- Tall non-mitered doors will have two center panels with cross rail.
- Tranter doors greater than 48" high will be two doors doweled together.

**Custom Modifications**

ACS	ADDTK	AUTHL AUTHR	CBO	CCO	CFNTO	CFRMO	CND	DRT	DRWTK	EXBKL EXBKR	EXL EXR
		STD	•	•	•	•					
FB	FFDL FFDR	FPEB	FTK	FTKAV FTKRV	ID	INVRM	MIP	RD	RECTKL RECTKR	RT	TD
		STD					•				
TKP	VTK	WLI									
											•

**Construction Upgrades**

APC	ET	PE
•		

**Door Options**

CG.TOP	DPSRR	MFO
•	•	•

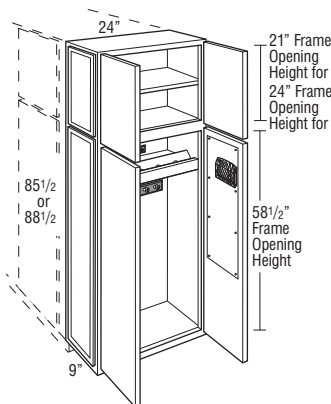

UOCDZ24909AHAL  
UOCDZ24909AHAR  
  
UOCDZ24939AHAL  
UOCDZ24939AHAR

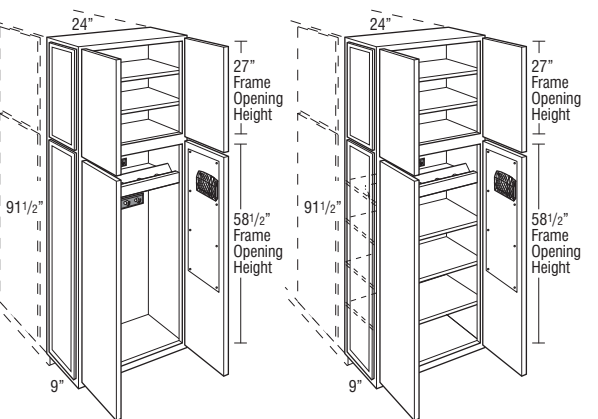
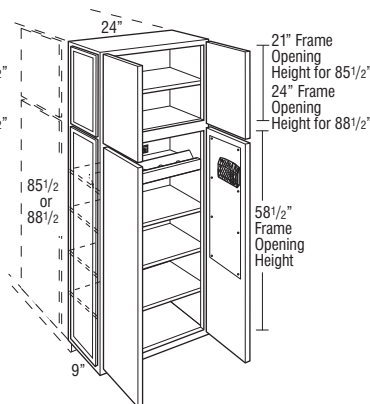

UOCDZ24969AEL  
UOCDZ24969AER

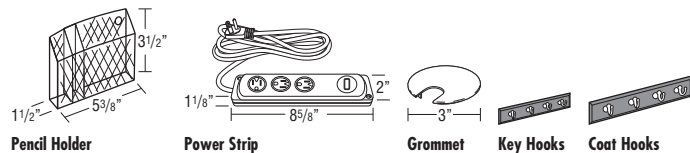

Pencil Holder

Power Strip

Grommet

Key Hooks

Coat Hooks

**PANTRY TOP UNIT with SHELVES,  
SINGLE DOOR, 24" DEEP**

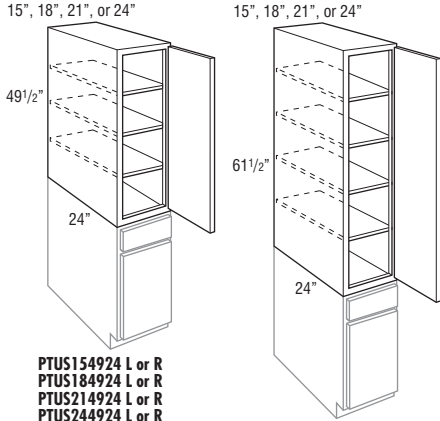

PTUS154924 L or R  
PTUS184924 L or R  
PTUS214924 L or R  
PTUS244924 L or R

PTUS156124 L or R  
PTUS186124 L or R  
PTUS216124 L or R  
PTUS246124 L or R

Model	Cubic Feet
PTUS154924 L or R	12.8
PTUS184924 L or R	15.1
PTUS214924 L or R	17.6
PTUS244924 L or R	19.9
PTUS156124 L or R	15.9
PTUS186124 L or R	18.8
PTUS216124 L or R	21.7
PTUS246124 L or R	24.6

- Three adjustable shelves included with 49 1/2" high, and four adjustable shelves included with 61 1/2" high.
- Sets on any 15", 18", 21", or 24" wide base (B15 shown). No countertop is needed.
- Can be reduced in depth to 6".
- Because of exposed seam when stacking, FPEB is not recommended.
- Be sure to use an end panel skin to connect the seam on the side of the stacked cabinets.
- Tall non-mitered doors will have two center panels with cross rail.
- Tranter doors will be two doors doweled together.

**Custom Modifications**

	ACS	ADDTK	AUTHL AUTHR	CBO	CCO	CFNTO	CFRMO	CND	DRT	DRWTK	EXBKL EXBKR	EXL EXR
		•	•*	•	•	•	•				•	•
FB	FFDL FFDR	FPEB	FTK	FTKAV FTKRV	ID	INVFRM	MIP	RD	RECTKL RECTKR	RT	TD	
•		•		•				•	•*			
TKP	VTK	WLI										
		•										

\*RD12 is not compatible with AUTHL or AUTHR

**Construction Upgrades**

APC	ET	PE
•		•

**Door Options**

CG.TOP	DPSRR	MFO
	•	•

**PANTRY TOP UNIT with SHELVES,  
DOUBLE DOOR, 24" DEEP**

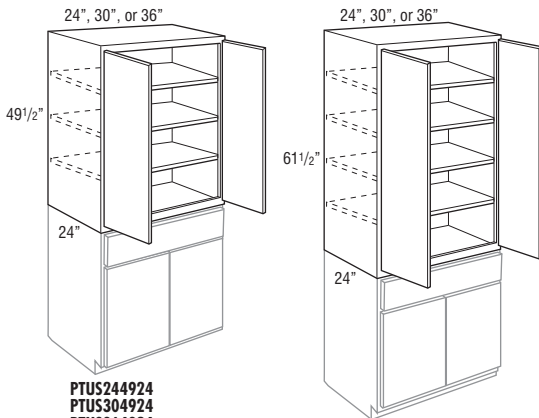

PTUS244924  
PTUS304924  
PTUS364924

PTUS246124  
PTUS306124  
PTUS366124

PTUS244924	19.9
PTUS304924	24.4
PTUS364924	29.0
PTUS246124	24.6
PTUS306124	30.2
PTUS366124	35.9

- Three adjustable shelves included with 49 1/2" high, and four adjustable shelves included with 61 1/2" high.
- Sets on any 24", 30", or 36" wide base (B30 shown). No countertop is needed.
- Can be reduced in depth to 6".
- Because of exposed seam when stacking, FPEB is not recommended.
- Be sure to use an end panel skin to connect the seam on the side of the stacked cabinets.
- Tall non-mitered doors will have two center panels with cross rail.
- Tranter doors will be two doors doweled together.

**Custom Modifications**

	ACS	ADDTK	AUTHL AUTHR	CBO	CCO	CFNTO	CFRMO	CND	DRT	DRWTK	EXBKL EXBKR	EXL EXR
		•	•*	•	•	•	•				•	•
FB	FFDL FFDR	FPEB	FTK	FTKAV FTKRV	ID	INVFRM	MIP	RD	RECTKL RECTKR	RT	TD	
•		•		•				•	•*			
TKP	VTK	WLI										
		•										

\*RD12 is not compatible with AUTHL or AUTHR

**Construction Upgrades**

APC	ET	PE
•		•

**Door Options**

CG.TOP	DPSRR	MFO
	•	•

**PANTRY TOP UNIT, SINGLE DOOR, 24" DEEP**

L G I X

15", 18", 21", or 24"

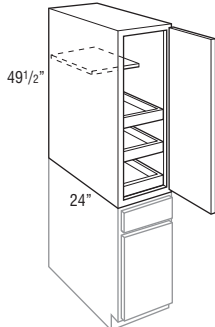

PTU154924 L or R  
PTU184924 L or R  
PTU214924 L or R  
PTU244924 L or R

15", 18", 21", or 24"

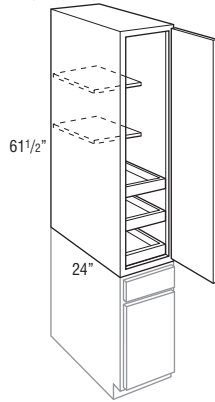

PTU156124 L or R  
PTU186124 L or R  
PTU216124 L or R  
PTU246124 L or R

Model	Cubic Feet
PTU154924 L or R	12.8
PTU184924 L or R	15.1
PTU214924 L or R	17.6
PTU244924 L or R	19.9
PTU156124 L or R	15.9
PTU186124 L or R	18.8
PTU216124 L or R	21.7
PTU246124 L or R	24.6

- One 15" deep adjustable shelf included with 49 1/2" high, and two 15" deep adjustable shelves included with 61 1/2" high.
- Three roll trays are included, installed in cabinet.
- Sets on any 15", 18", 21", or 24" wide base (B15 shown). No countertop is needed.
- Can be reduced in depth to 12".
- Because of exposed seam when stacking, FPEB is not recommended.
- Be sure to use an end panel skin to connect the seam on side of stacked cabinets.
- Tall non-mitered doors will have two center panels with cross rail.
- Tranter doors will be two doors doweled together.

**Custom Modifications**

ACS	ADDTK	AUTHL AUTHR	CBO	CCO	CFNTO	CFRMO	CND	DRT	DRWTK	EXBKL EXBKR	EXL EXR
		•*	•		•	•		•		•	•
FB	FFDL FFDR	FPEB	FTK	FTKAV FTKFV	ID	INVFRM	MIP	RD	RECTKL RECTKR	RT	TD
•		•					•	•*			
TKP	VTK	WLI									
		•									

\*RD12 is not compatible with AUTHL or AUTHR

**Construction Upgrades**

APC	ET	PE
•		•

**Door Options**

CG.TOP	DPSRR	MFO
	•	•

**PANTRY TOP UNIT, DOUBLE DOOR, 24" DEEP**

L G I X

24", 30", or 36"

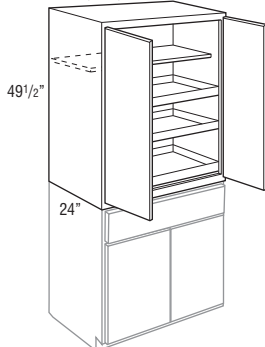

PTU244924  
PTU304924  
PTU364924

24", 30", or 36"

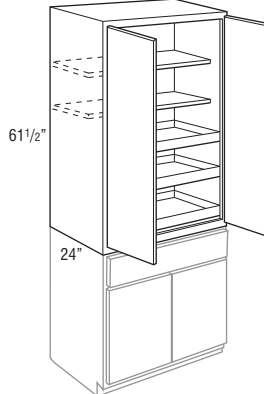

PTU246124  
PTU306124  
PTU366124

PTU244924	19.9
PTU304924	24.4
PTU364924	29.0
PTU246124	24.6
PTU306124	30.2
PTU366124	35.9

- One 15" deep adjustable shelf included with 49 1/2" high, and two 15" deep adjustable shelves included with 61 1/2" high.
- Three roll trays are included, installed in cabinet.
- Sets on any 24", 30", or 36" wide base. (B30 shown.) No countertop is needed.
- Can be reduced in depth to 12".
- Because of exposed seam when stacking, FPEB is not recommended.
- Be sure to use an end panel skin to connect the seam on side of stacked cabinets.
- Tall non-mitered doors will have two center panels with cross rail.
- Tranter doors will be two doors doweled together.

**Custom Modifications**

ACS	ADDTK	AUTHL AUTHR	CBO	CCO	CFNTO	CFRMO	CND	DRT	DRWTK	EXBKL EXBKR	EXL EXR
		•*	•	•	•	•		•		•	•
FB	FFDL FFDR	FPEB	FTK	FTKAV FTKFV	ID	INVFRM	MIP	RD	RECTKL RECTKR	RT	TD
•		•					•	•*			
TKP	VTK	WLI									
		•									

\*RD12 is not compatible with AUTHL or AUTHR

**Construction Upgrades**

APC	ET	PE
•		•

**Door Options**

CG.TOP	DPSRR	MFO
	•	•

**PANTRY TOP UNIT with PULL-OUT, 49 1/2" TALL, 24" DEEP**

L O G I X

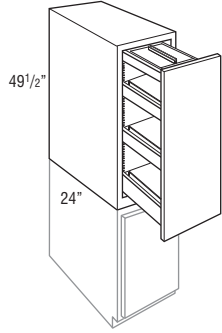

Model	Cubic Feet
PTUP154924	15.8
PTUP184924	18.7

- Two adjustable and one fixed bottom shelf with metallic finish wire rail sides. Natural finish pull-out shelves are 20 11/16" deep.
- Sets on any 15" or 18" wide base. No countertop is needed.
- Because of exposed seam when stacking, FPEB is not recommended.
- Be sure to use an end panel skin to connect the seam on side of stacked cabinets.
- Tall non-mitered doors will have two center panels with cross rail.
- Tranter doors greater than 48" high will be two doors doweled together.
- For full access from both sides of unit, do not install against a wall or next to deeper appliances and cabinets.

**Custom Modifications**

ACS	ADDTK	AUTHL AUTHR	CBO	CCO	CFNTD	CFRMO	CND	DRT	DRWTK	EXBKL EXBKR	EXL EXR
		•	•	•		•				•	•
FB	FFDL FFDR	FPEB	FTK	FTKAV FTKFV	ID	INVFRM	MIP	RD	RECTKL RECTKR	RT	TD
•		•					•				
TKP	VTK	WLI									
•	•	•									

**Construction Upgrades**

APC	ET	PE
•		•

**Door Options**

CG.TOP	DPSRR	MFO
	•	•

**TALL PANTRY PULL-OUT, 84", 87", or 90" TALL, 24" DEEP**

L O G I X

9", 12", 15", or 18"

9", 12", 15", or 18"

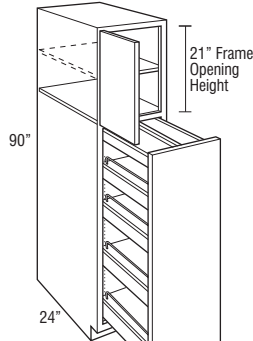
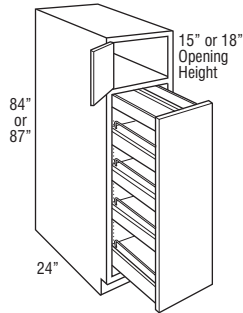

TPP98424 L or R  
TPP128424 L or R  
TPP158424 L or R  
TPP188424 L or R

TPP98724 L or R  
TPP128724 L or R  
TPP158724 L or R  
TPP188724 L or R

TPP99024AH L or R  
TPP129024AH L or R  
TPP159024AH L or R  
TPP189024AH L or R

TPP98424 L or R	13.8
TPP128424 L or R	17.7
TPP158424 L or R	21.6
TPP188424 L or R	25.6
TPP98724 L or R	14.3
TPP128724 L or R	18.3
TPP158724 L or R	22.4
TPP188724 L or R	26.5
TPP99024AH L or R	14.7
TPP129024AH L or R	18.9
TPP159024AH L or R	23.2
TPP189024AH L or R	27.4

- AH represents upper section alignment with doors on 24" or 27" high cabinets.
- Three adjustable shelves and one fixed bottom shelf with metallic finish wire rail sides. Natural finish wood pull-out shelves are 20 11/16" deep. Pull-out features top/bottom mounted soft-close full extension guides.
- 84" and 87" high do not include shelves in upper section. Upper section 15" or 18".
- Tall non-mitered doors will have two center panels with cross rail.
- Tranter doors greater than 48" high will be two doors doweled together.
- For full access from both sides of unit, do not install against a wall or next to deeper appliances and cabinets.
- Pull-out mechanism not available for order for field installation, only available factory installed.

**Custom Modifications**

ACS	ADDTK	AUTHL AUTHR	CBO	CCO	CFNTD	CFRMO	CND	DRT	DRWTK	EXBKL EXBKR	EXL EXR
		•	•	•		•			•*	•	•
FB	FFDL FFDR	FPEB	FTK	FTKAV FTKFV	ID	INVFRM	MIP	RD	RECTKL RECTKR	RT	TD
•		•	•	•*			•		•		•
TKP	VTK	WLI									
•	•	•									

\*Available only on 18" wide

\*Not available on 9" and 12" wide

**Construction Upgrades**

APC	ET	PE
•		•

**Door Options**

CG.TOP	DPSRR	MFO
	•	•

**TALL PANTRY PULL-OUT, 93" or 96" TALL, 24" DEEP**

9", 12", 15", or 18"

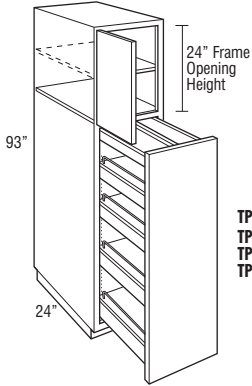

**TPP99324AH L or R**  
**TPP129324AH L or R**  
**TPP159324AH L or R**  
**TPP189324AH L or R**

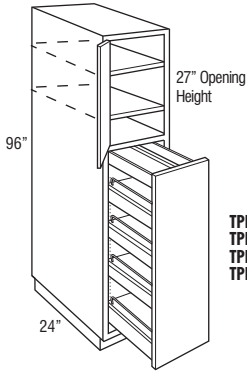

**TPP99624 L or R**  
**TPP129624 L or R**  
**TPP159624 L or R**  
**TPP189624 L or R**

L G I X

Model	Cubic Feet
TPP99324AH L or R	15.2
TPP129324AH L or R	19.6
TPP159324AH L or R	23.9
TPP189324AH L or R	28.3
TPP99624 L or R	15.7
TPP129624 L or R	20.2
TPP159624 L or R	24.7
TPP189624 L or R	29.2

- AH represents upper section alignment with doors on 24" or 27" high cabinets.
- Three adjustable shelves and one fixed bottom shelf with metallic finish wire rail sides. Natural finish wood pull-out shelves are 20 11/16" deep. Pull-out features top/bottom mounted soft-close full extension guides.
- Separate pedestal base included but packaged separately on 93" and 96" tall. Pedestal is designed to create a Recessed Left or Right Toekick application during field installation, or can be centered. Pedestal must be covered with toeboard material.
- Tall non-mitered doors will have two center panels with cross rail.
- Tranter doors greater than 48" high will be two doors doweled together.
- For full access from both sides of unit, do not install against a wall or next to deeper appliances and cabinets.
- Pull-out mechanism not available for order for field installation, only available factory installed.

**Custom Modifications**

ACS	ADDTK	AUTHL AUTHR	CBO	CCO	CFNTO	CFRMO	CND	DRT	DRWTK	EXBKL EXBKR	EXL EXR
		•	•	•		•				•	•
FB	FFDL FFDR	FPEB	FTK	FTKAV FTKFV	ID	INVFRM	MIP	RD	RECTKL RECTKR	RT	TD
•		•					•		•		•
TKP	VTK	WLI									
		•									

**Construction Upgrades**

APC	ET	PE
•		•

**Door Options**

CG.TOP	DPSRR	MFO
•	•	•

**UTILITY STORAGE with PANTRY  
PULL-OUT, 84", 87", 90", 93", or  
96" TALL, 24" DEEP**

LOGIX

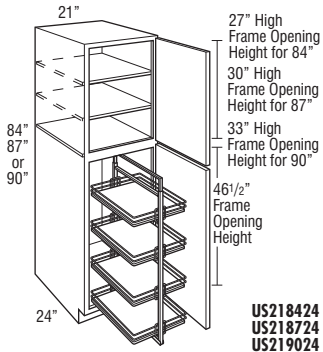

US218424 L or R  
US218724 L or R  
US219024 L or R

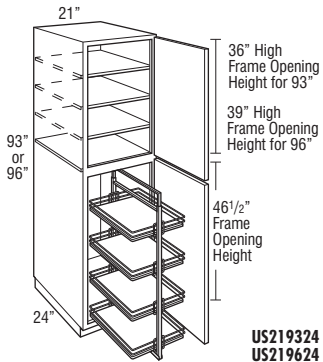

US219324 L or R  
US219624 L or R

Model	Cubic Feet
US218424 L or R	29.5
US218724 L or R	30.5
US219024 L or R	31.6
US219324 L or R	32.6
US219624 L or R	33.6

- If Decorative Door End panels are desired see DADOORB and DADOORW.
- Full extension pantry pull-out with four plywood shelves and metal rails. Each shelf is 17" wide, 20 7/16" deep, and 4" high.
- Separate pedestal base included but packaged separately on 93" and 96" tall. Pedestal is designed to create a Recessed Left or Right Toe Kick application during field installation, or can be centered. Pedestal must be covered with toeboard material.
- Tall non-mitered doors will have two center panels with cross rail.
- Tranter doors greater than 48" high will be two doors doweled together.

**Custom Modifications**

ACS	ADDTK	AUTHL AUTHR	CBO	CCO	CFNTD	CFRMO	CND	DRT	DRWTK	EXBKL EXBKR	EXL EXR
			•	•	•	•			•*	•	•
FB	FFDL FFDR	FPEB	FTK	FTKAV FTKRV	ID	INVRM	MIP	RD	RECTKL RECTKR	RT	TD
•		•	•*	•*			•		•		
TKP	VTK	WLI									
•*	•*	•									

\*Not available on 93" and 96" tall

**Construction Upgrades**

APC	ET	PE
•		•

**Door Options**

CG.TOP	DPSRR	MFO
•	•	•

**UTILITY STORAGE with PANTRY  
PULL-OUT and POT and PAN RACK,  
84", 87", 90", 93", or 96" TALL,  
24" DEEP**

LOGIX

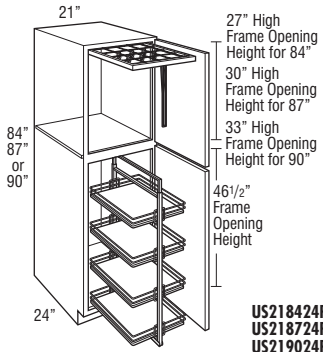

US218424PP L or R  
US218724PP L or R  
US219024PP L or R

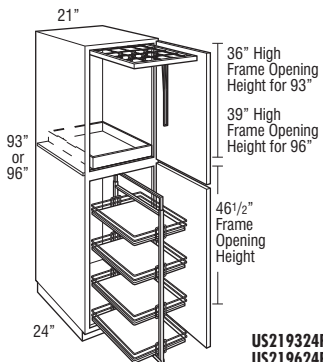

US219324PP L or R  
US219624PP L or R

US218424PP L or R	29.5
US218724PP L or R	30.5
US219024PP L or R	31.6
US219324PP L or R	32.6
US219624PP L or R	33.6

- Full extension Pot and Pan Rack features six chrome hooks and is mounted to the top of the cabinet. Maximum Weight Capacity: 47 lbs.
- Full extension pantry pull-out with four plywood shelves and metal rails. Each shelf is 17" wide, 20 7/16" deep, and 4" high.
- Separate pedestal base included but packaged separately on 93" and 96" tall. Pedestal is designed to create a Recessed Left or Right Toe Kick application during field installation, or can be centered. Pedestal must be covered with toeboard material.
- Tall non-mitered doors will have two center panels with cross rail.
- Tranter doors greater than 48" high will be two doors doweled together.

**Custom Modifications**

ACS	ADDTK	AUTHL AUTHR	CBO	CCO	CFNTD	CFRMO	CND	DRT	DRWTK	EXBKL EXBKR	EXL EXR
			•	•	•	•			•*	•	•
FB	FFDL FFDR	FPEB	FTK	FTKAV FTKRV	ID	INVRM	MIP	RD	RECTKL RECTKR	RT	TD
•		•	•*	•*			•		•		
TKP	VTK	WLI									
•*	•*	•									

\*Not available on 93" and 96" tall

**Construction Upgrades**

APC	ET	PE
•		•

**Door Options**

CG.TOP	DPSRR	MFO
	•	•



**PANTRY UNIT, 84", 87", 90", 93", or 96" TALL, 24" DEEP**

L G I X

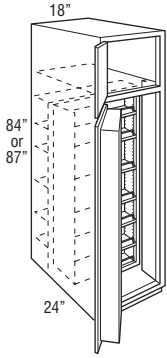

**PY188424 L or R  
PY188724 L or R**

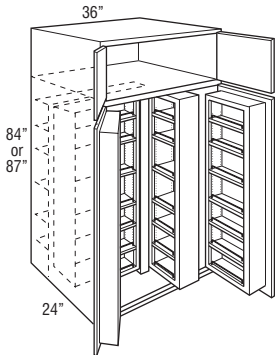

**PY368424  
PY368724**

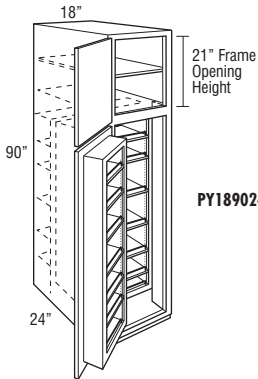

**PY189024AH L or R**

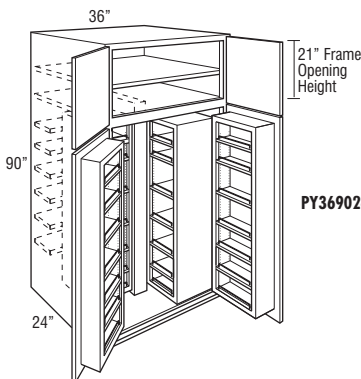

**PY369024AH**

Model	Cubic Feet	Model	Cubic Feet
<b>PY188424 L or R</b>	25.6	<b>PY189024AH L or R</b>	27.4
<b>PY368424</b>	49.2	<b>PY369024AH</b>	52.6
<b>PY188724 L or R</b>	26.5		
<b>PY368724</b>	50.9		

- Shelves on swing-out units, mounting rails, and door racks have a furniture board core with natural finish wood fronts and metallic finish wire rails. Door mounted rack includes 6 adjustable shelves and one fixed shelf. Swing-outs include 4 adjustable shelves and 3 fixed shelves. Swing-out and door racks included but shipped separately for field installation, includes mounting screws and installation instructions. Adjustable shelves for use in back of cabinet are 4 1/2" deep, six included.
- For PY18, use TF384 when installed against wall (or next to a full depth refrigerator.)
- Tall non-mitered doors will have two center panels with cross rail.
- Tranter doors greater than 48" high will be two doors doveled together.

- AH represents upper section alignment with doors on 24" or 27" high cabinets.
- Shelves on swing-out units, mounting rails, and door racks have a furniture board core with natural finish wood fronts and metallic finish wire rails. Door mounted rack includes 6 adjustable shelves and one fixed shelf. Swing-outs include 4 adjustable shelves and 3 fixed shelves. Swing-out and door racks included but shipped separately for field installation, includes mounting screws and installation instructions. Adjustable shelves for use in back of cabinet are 4 1/2" deep, six included.
- For PY18, use TF390 when installed against wall (or next to a full depth refrigerator.)
- Tall non-mitered doors will have two center panels with cross rail.
- Tranter doors greater than 48" high will be two doors doveled together.

- Shelves on swing-out units, mounting rails, and door racks have a furniture board core with natural finish wood fronts and metallic finish wire rails. Door mounted rack includes 6 adjustable shelves and one fixed shelf. Swing-outs include 4 adjustable shelves and 3 fixed shelves. Swing-out and door racks included but shipped separately for field installation, includes mounting screws and installation instructions. Adjustable shelves for use in back of cabinet are 4 1/2" deep, six included.
- For PY18, use TF387 when installed against wall (or next to a full depth refrigerator.)
- Tall non-mitered doors will have two center panels with cross rail.
- Tranter doors greater than 48" high will be two doors doveled together.

**Custom Modifications**

ACS	ADDTK	AUTHL AUTHR	CBO	CCO	CFNTO	CFRMO	CND	DRT	DRWTK	EXBKL EXBKR	EXL EXR
		•	•		•	•			•	•	•
FB	FFDL FFDR	FPEB	FTK	FTKAV FTKRV	ID	INVRM	MIP	RD	RECTKL RECTKR	RT	TD
•		•	•	•			•		•		•
TKP	VTK	WLI									
•	•	•									

**Construction Upgrades**

APC	ET	PE
•		•

**Door Options**

CG.TOP	DPSRR	MFO
•	•	•

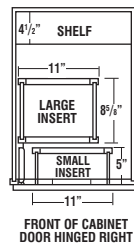

PY18R

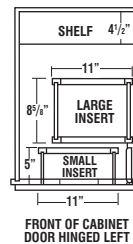

PY18L

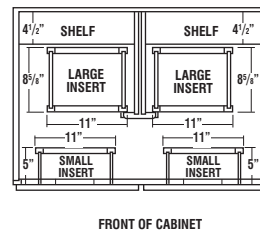

PY36

**Wood inserts for all styles:**

- Top view of wood inserts positioning and size.
- Wood inserts are 56" high.

PANTRY UNIT, 84", 87", 90", 93", or 96" TALL, 24" DEEP (cont'd) L O G I X

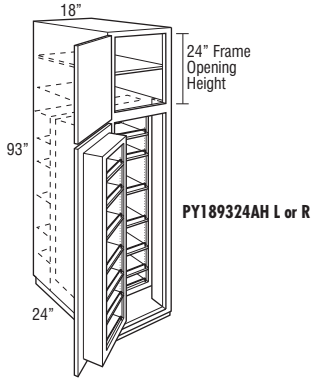

PY189324AH L or R

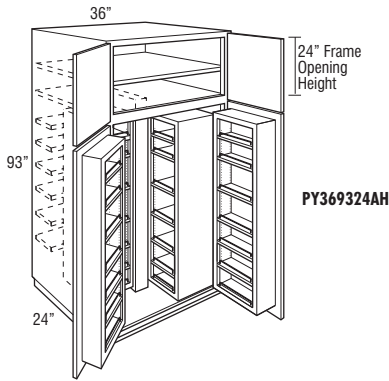

PY369324AH

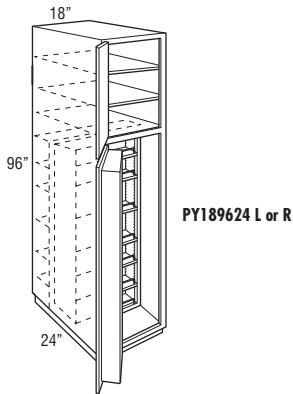

PY189624 L or R

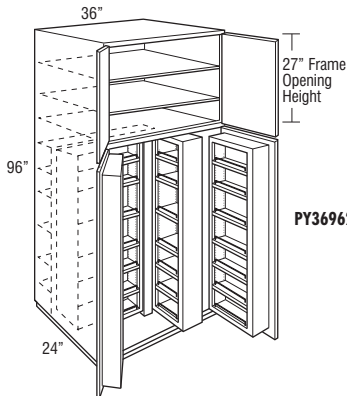

PY369624

Model	Cubic Feet
PY189324AH L or R	28.3
PY369324AH	54.3

Model	Cubic Feet
PY189624 L or R	29.2
PY369624	56.1

- AH represents upper section alignment with doors on 24" or 27" high cabinets.
- Shelves on swing-out units, mounting rails, and door racks have a furniture board core with natural finish wood fronts and metallic finish wire rails. Door mounted rack includes 6 adjustable shelves and one fixed shelf. Swing-outs include 4 adjustable shelves and 3 fixed shelves. Swing-out and door racks included but shipped separately for field installation, includes mounting screws and installation instructions. Adjustable shelves for use in back of cabinet are 4 1/2" deep, six included.
- Separate pedestal base included but packaged separately on 93" tall. Pedestal is designed to create a Recessed Left or Right Toekick application during field installation, or can be centered. Pedestal must be covered with toeboard material.
- For PY18, use TF396 when installed against wall (or next to a full depth refrigerator.)
- Tall non-mitered doors will have two center panels with cross rail.
- Tranter doors greater than 48" high will be two doors doweled together.

- Shelves on swing-out units, mounting rails, and door racks have a furniture board core with natural finish wood fronts and metallic finish wire rails. Door mounted rack includes 6 adjustable shelves and one fixed shelf. Swing-outs include 4 adjustable shelves and 3 fixed shelves. Swing-out and door racks included but shipped separately for field installation, includes mounting screws and installation instructions. Adjustable shelves for use in back of cabinet are 4 1/2" deep, six included.
- Separate pedestal base included but packaged separately on 96" tall. Pedestal is designed to create a Recessed Left or Right Toekick application during field installation, or can be centered. Pedestal must be covered with toeboard material.
- For PY18, use TF396 when installed against wall (or next to a full depth refrigerator.)
- Tall non-mitered doors will have two center panels with cross rail.
- Tranter doors greater than 48" high will be two doors doweled together.

Custom Modifications

ACS	ADDTK	AUTHL AUTHR	CBO	CCO	CFNTD	CFRMO	CND	DRT	DRWTK	EXBKL EXBKR	EXL EXR
		•	•	•	•	•				•	•
FB	FFDL FFDR	FPEB	FTK	FTKAV FTKRV	ID	INVFRM	MIP	RD	RECTKL RECTKR	RT	TD
•		•					•		•		•
TKP	VTK	WLI									
		•									

Construction Upgrades

APC	ET	PE
•		•

Door Options

CG.TOP	DPSRR	MFO
•	•	•

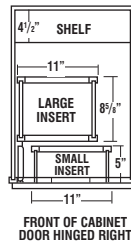

PY18R

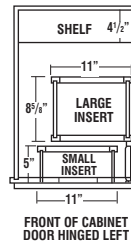

PY18L

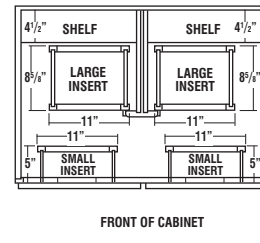

PY36

Wood inserts for all styles:

- Top view of wood inserts positioning and size.
- Wood inserts are 56" high.

**PANTRY WALK-THROUGH, 84", 87", 90", 93", or 96" TALL, 24" DEEP**

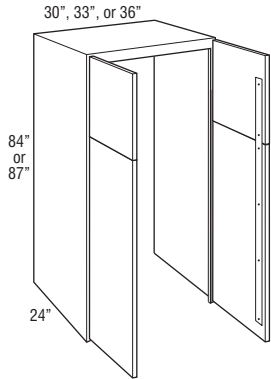

PWT308424  
PWT338424  
PWT368424  
PWT308724  
PWT338724  
PWT368724

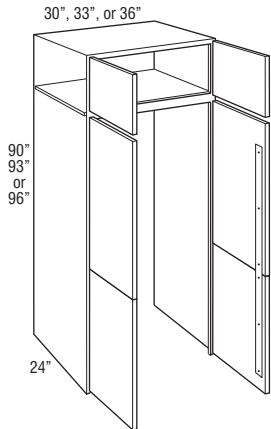

PWT309024  
PWT339024  
PWT369024  
PWT309324  
PWT339324  
PWT369324  
PWT309624  
PWT339624  
PWT369624

Model	Cubic Feet
PWT308424	41.3
PWT338424	45.2
PWT368424	49.2
PWT308724	42.8
PWT338724	46.8
PWT368724	50.9
PWT309024	44.3
PWT339024	48.7
PWT369024	53.1
PWT309324	45.7
PWT339324	50.3
PWT369324	54.9
PWT309624	47.2
PWT339624	51.9
PWT369624	56.6

- Cabinet does not have a bottom. 84" and 87" high do not have a back, 90"-96" high only have a back in the upper section. Doors are braced together, are 1/4" shorter than the cabinet for floor clearance, and use standard 107° Smart Stop hinges.
- Not available in Catalina, Trystan, Worthen.
- Can be reduced in depth to 9" or increased in depth to 27".
- CG and glass inserts only available on upper doors of 90"-96" tall.
- Authentic Ends uses the standard tall door configuration by height and will not align with the front doors. A tall end panel skin can be used to conceal door attachment screws on the interior of the cabinet end panel (see TEPS\_\_WD on page 365).
- Height of ceiling needs to be considered for installation, 96" high cabinet requires 99" of height for 24" deep and 100" of height for 27" deep to stand unit upright.
- Cabinet will be shipped with additional attached supports to be removed during installation.
- ICMB (Inside Corner Moulding) can be used to conceal staples behind the face frame.
- SSM8 (Small Scribe Moulding) can be used to conceal exposed back edges of the end panels, which are not edgebanded.
- End panels will not be drilled for shelves.
- If ordered in Arch style on 84" and 87" tall, the top doors of 84" and 87" will feature Arch profile. On 90"-96" tall, only the doors on the upper section will feature Arch profile.

	PO Door Height			FO Door Height			MFO Door Height		
	Top Door	Middle Door	Bottom Door	Top Door	Middle Door	Bottom Door	Top Door	Middle Door	Bottom Door
PWT308424	23 1/4"	N/A	59 1/2"	22 1/2"	N/A	61"	21 3/4"	N/A	61"
PWT338424	23 1/4"	N/A	59 1/2"	22 1/2"	N/A	61"	21 3/4"	N/A	61"
PWT368424	23 1/4"	N/A	59 1/2"	22 1/2"	N/A	61"	21 3/4"	N/A	61"
PWT308724	26 1/4"	N/A	59 1/2"	25 1/2"	N/A	61"	24 3/4"	N/A	61"
PWT338724	26 1/4"	N/A	59 1/2"	25 1/2"	N/A	61"	24 3/4"	N/A	61"
PWT368724	26 1/4"	N/A	59 1/2"	25 1/2"	N/A	61"	24 3/4"	N/A	61"
PWT309024	10"	43 1/2"	33 1/4"	11 1/2"	43 1/2"	34"	10 3/4"	43 1/2"	34"
PWT339024	10"	43 1/2"	33 1/4"	11 1/2"	43 1/2"	34"	10 3/4"	43 1/2"	34"
PWT369024	10"	43 1/2"	33 1/4"	11 1/2"	43 1/2"	34"	10 3/4"	43 1/2"	34"
PWT309324	13"	43 1/2"	33 1/4"	14 1/2"	43 1/2"	34"	13 3/4"	43 1/2"	34"
PWT339324	13"	43 1/2"	33 1/4"	14 1/2"	43 1/2"	34"	13 3/4"	43 1/2"	34"
PWT369324	13"	43 1/2"	33 1/4"	14 1/2"	43 1/2"	34"	13 3/4"	43 1/2"	34"
PWT309624	16"	43 1/2"	33 1/4"	17 1/2"	43 1/2"	34"	16 3/4"	43 1/2"	34"
PWT339624	16"	43 1/2"	33 1/4"	17 1/2"	43 1/2"	34"	16 3/4"	43 1/2"	34"
PWT369624	16"	43 1/2"	33 1/4"	17 1/2"	43 1/2"	34"	16 3/4"	43 1/2"	34"

**Custom Modifications**

ACS	ADDTK	AUTHL AUTHR	CBO	CCO	CFNTO	CFRMO	CND	DRT	DRWTK	EXBKL EXBKR	EXL EXR
		•									•
FB	FFDL FFDR	FPEB	FTK	FTKAV FTKFV	ID	INVRM	MIP	RD	RECTKL RECTKR	RT	TD
		STD			•		•	•			
TKP	VTK	WLI									
		•									

**Construction Upgrades**

APC	ET	PE
STD		

**Door Options**

CG.TOP	DPSRR	MFO
•	•	•

<sup>†</sup>Available only on 90"-96" high

**SINGLE OVEN CABINET,  
84", 87", or 90" TALL, 24" DEEP**

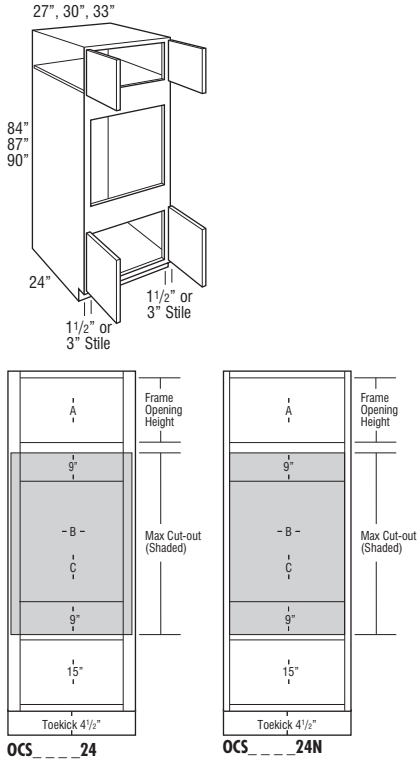

Model	Cubic Feet
OCS278424(N)	37.4
OCS308424(N)	41.3
OCS338424(N)	45.2
OCS278724(N)	38.7
OCS308724(N)	42.8
OCS338724(N)	46.8
OCS279024 (AH or N)	40.0
OCS309024 (AH or N)	44.2
OCS339024 (AH or N)	48.4

- AH represents upper section alignment with doors on 24" or 27" high cabinets.
- N represents Narrow Stile cabinets with 1 1/2" wide face frame side stiles and ACS modification availability (see page 46 for ACS specifications). Doors have a consistent width reveal for full overlay (1/4") and partial overlay (1") and use standard Smart Stop hinges.
- On cabinets with 3" wide face frame side stiles, full overlay styles have a consistent 1/4" width frame reveal and use face mounted Smart Stop hinges. Partial overlay styles have a larger 2 1/2" width reveal, use standard Smart Stop hinges, and are not recommended for stacking applications due to misalignment of door width with cabinets above.
- Upper section on 90" tall has one full depth adjustable shelf.
- All top and bottom cross rails are 1 1/2" wide.
- Be sure to confirm a heat shield is built into your appliance by the manufacturer or install the heat shield included with your appliance. Heat shields are sold separately as an accessory.
- Depth can be reduced to a minimum of 6". For depths of 6"-8", cabinet will not include toekick/pedestal.
- For built-in appliance support, OCINSTALLKIT is included in 24" deep oven cabinets (see page 422 for details). Oven install kit will not be included when depth is modified.
- Oven cabinets feature an open back in cut-out area designed to improve field appliance installation.
- Maximum cut-out dimension will allow 1/4" reveal for doors and drawer fronts on full overlay and 1" for partial overlay for trim kit face clearance.

	A Frame Opening Height	B Cut-out Width		C Cut-out Height		Door Height (Upper Section)	
		Min.	Max.	Min.	Max.	Partial Overlay	Full Overlay
OCS278424	15"	21"	25 1/2"	28 1/2"	43 1/2"	16"	17 1/2"
OCS308424	15"	24"	28 1/2"	28 1/2"	43 1/2"	16"	17 1/2"
OCS338424	15"	27"	31 1/2"	28 1/2"	43 1/2"	16"	17 1/2"
OCS278724	18"	21"	25 1/2"	28 1/2"	43 1/2"	19"	20 1/2"
OCS308724	18"	24"	28 1/2"	28 1/2"	43 1/2"	19"	20 1/2"
OCS338724	18"	27"	31 1/2"	28 1/2"	43 1/2"	19"	20 1/2"
OCS279024AH	21"	21"	25 1/2"	28 1/2"	43 1/2"	22"	23 1/2"
OCS309024AH	21"	24"	28 1/2"	28 1/2"	43 1/2"	22"	23 1/2"
OCS339024AH	21"	27"	31 1/2"	28 1/2"	43 1/2"	22"	23 1/2"

	A Frame Opening Height	B Cut-out Width (standard)		B Cut-out Width (with ACS modification)			C Cut-out Height		Door Height (Upper Section)	
		Min.	Max.	Min.	Max.	Max. w/ Field Cut	Min.	Max.	Partial Overlay	Full Overlay
OCS278424N	15"	24"	25 1/2"	21"	24"	25 1/2"	28 1/2"	43 1/2"	16"	17 1/2"
OCS308424N	15"	27"	28 1/2"	24"	27"	28 1/2"	28 1/2"	43 1/2"	16"	17 1/2"
OCS338424N	15"	30"	31 1/2"	27"	30"	31 1/2"	28 1/2"	43 1/2"	16"	17 1/2"
OCS278724N	18"	24"	25 1/2"	21"	24"	25 1/2"	28 1/2"	43 1/2"	19"	20 1/2"
OCS308724N	18"	27"	28 1/2"	24"	27"	28 1/2"	28 1/2"	43 1/2"	19"	20 1/2"
OCS338724N	18"	30"	31 1/2"	27"	30"	31 1/2"	28 1/2"	43 1/2"	19"	20 1/2"
OCS279024N	21"	24"	25 1/2"	21"	24"	25 1/2"	28 1/2"	43 1/2"	22"	23 1/2"
OCS309024N	21"	27"	28 1/2"	24"	27"	28 1/2"	28 1/2"	43 1/2"	22"	23 1/2"
OCS339024N	21"	30"	31 1/2"	27"	30"	31 1/2"	28 1/2"	43 1/2"	22"	23 1/2"

**Custom Modifications**

ACS	ADDTK	AUTHL AUTHR	CBO	CCO	CFNTO	CFRMO	CND	DRT	DRWTK	EXBKL EXBKR	EXL EXR
•*		•	•+	•	•	•			•	•	•
FB	FFDL FFDR	FPEB	FTK	FTKAV FTKFV	ID	INVFRM	MIP	RD	RECTKL RECTKR	RT	TD
•	•	•	•	•			•	•	•		•
TKP	VTK	WLI									
•	•	•									

\*Only available on Narrow Stile (N) cabinets    +Not available on 84" and 87" tall

**Construction Upgrades**

APC	ET	PE
•		•

**Door Options**

CG.TOP	DPSRR	MFO
	•	•

**SINGLE OVEN CABINET,  
93" or 96" TALL, 24" DEEP**

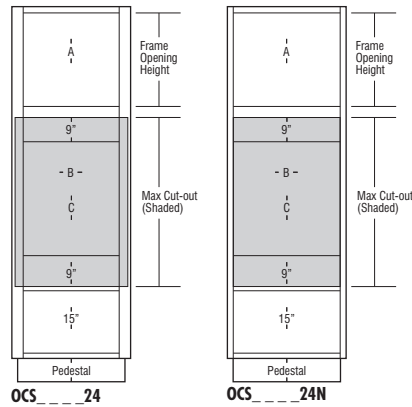
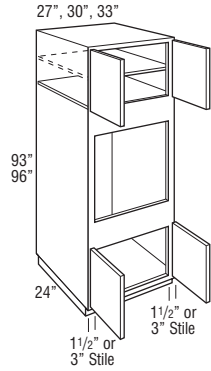

Model	Cubic Feet
OCS279324 (AH or N)	41.3
OCS309324 (AH or N)	45.7
OCS339324 (AH or N)	50.0
OCS279624(N)	42.6
OCS309624(N)	47.1
OCS339624(N)	51.6

- AH represents upper section alignment with doors on 24" or 27" high cabinets.
- N represents Narrow Stile cabinets with 1 1/2" wide face frame side stiles and ACS modification availability (see page 46 for ACS specifications). Doors have a consistent width reveal for full overlay (1/4") and partial overlay (1") and use standard Smart Stop hinges.
- On cabinets with 3" wide face frame side stiles, full overlay styles have a consistent 1/4" width frame reveal and use face mounted Smart Stop hinges. Partial overlay styles have a larger 2 1/2" width reveal, use standard Smart Stop hinges, and are not recommended for stacking applications due to misalignment of door width with cabinets above.
- Includes adjustable shelves in upper section:  
93" tall - one shelf  
96" tall - two shelves
- All top and bottom cross rails are 1 1/2" wide.
- Be sure to confirm a heat shield is built into your appliance by the manufacturer or install the heat shield included with your appliance. Heat shields are sold separately as an accessory.
- Separate pedestal base included but packaged separately on 93" and 96" tall. Pedestal is designed to create a Recessed Left or Right Toe Kick application during field installation, or can be centered. Pedestal must be covered with toeboard material.
- Depth can be reduced to a minimum of 6". For depths of 6"-8", cabinet will not include toe kick/pedestal.
- For built-in appliance support, OCINSTALLKIT is included in 24" deep oven cabinets (see page 422 for details). Oven install kit will not be included when depth is modified.
- Oven cabinets feature an open back in cut-out area designed to improve field appliance installation.
- Maximum cut-out dimension will allow 1/4" reveal for doors and drawer fronts on full overlay and 1" for partial overlay for trim kit face clearance.

	A Frame Opening Height	B Cut-out Width		C Cut-out Height		Door Height (Upper Section)	
		Min.	Max.	Min.	Max.	Partial Overlay	Full Overlay
OCS279324AH	24"	21"	25 1/2"	28 1/2"	43 1/2"	25"	26 1/2"
OCS309324AH	24"	24"	28 1/2"	28 1/2"	43 1/2"	25"	26 1/2"
OCS339324AH	24"	27"	31 1/2"	28 1/2"	43 1/2"	25"	26 1/2"
OCS279624	27"	21"	25 1/2"	28 1/2"	43 1/2"	28"	29 1/2"
OCS309624	27"	24"	28 1/2"	28 1/2"	43 1/2"	28"	29 1/2"
OCS339624	27"	27"	31 1/2"	28 1/2"	43 1/2"	28"	29 1/2"

	A Frame Opening Height	B Cut-out Width (standard)		B Cut-out Width (with ACS modification)			C Cut-out Height		Door Height (Upper Section)	
		Min.	Max.	Min.	Max.	Max. w/ Field Cut	Min.	Max.	Partial Overlay	Full Overlay
OCS279324N	24"	24"	25 1/2"	21"	24"	25 1/2"	28 1/2"	43 1/2"	25"	26 1/2"
OCS309324N	24"	27"	28 1/2"	24"	27"	28 1/2"	28 1/2"	43 1/2"	25"	26 1/2"
OCS339324N	24"	30"	31 1/2"	27"	30"	31 1/2"	28 1/2"	43 1/2"	25"	26 1/2"
OCS279624N	27"	24"	25 1/2"	21"	24"	25 1/2"	28 1/2"	43 1/2"	28"	29 1/2"
OCS309624N	27"	27"	28 1/2"	24"	27"	28 1/2"	28 1/2"	43 1/2"	28"	29 1/2"
OCS339624N	27"	30"	31 1/2"	27"	30"	31 1/2"	28 1/2"	43 1/2"	28"	29 1/2"

**Custom Modifications**

ACS	ADDTK	AUTHL AUTHR	CBO	CCO	CFNTO	CFRMO	CND	DRT	DRWTK	EXBKL EXBKR	EXL EXR
*		•	•	•	•	•				•	•
FB	FFDL FFDR	FPEB	FTK	FTKAV FTKRV	ID	INVFRM	MIP	RD	RECTKL RECTKR	RT	TD
•		•			•		•	•	•		•
TKP	VTK	WLI									
		•									

\*Only available on Narrow Stile (N) cabinets

**Construction Upgrades**

APC	ET	PE
•		•

**Door Options**

CG.TOP	DPSRR	MFO
	•	•

**SINGLE OVEN CABINET, DEEP DRAWER, 84", 87", or 90" TALL, 24" DEEP**

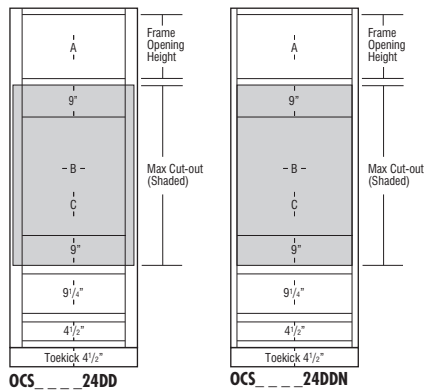
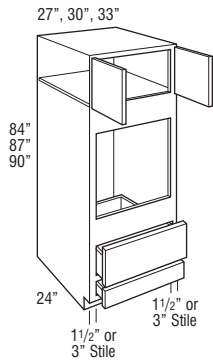

TALL CABINETS

Model	Cubic Feet
OCS278424DD(N)	37.4
OCS308424DD(N)	41.3
OCS338424DD(N)	45.2
OCS278724DD(N)	38.7
OCS308724DD(N)	42.8
OCS338724DD(N)	46.8
OCS279024DD (AH or N)	40.0
OCS309024DD (AH or N)	44.2
OCS339024DD (AH or N)	48.4

- AH represents upper section alignment with doors on 24" or 27" high cabinets.
- N represents Narrow Stile cabinets with 1 1/2" wide face frame side stiles and ACS modification availability (see page 46 for ACS specifications). Doors and drawer fronts have a consistent width reveal for full overlay (1/4") and partial overlay (1") and use standard Smart Stop hinges.
- On cabinets with 3" wide face frame side stiles, full overlay styles have a consistent 1/4" width frame reveal and use face mounted Smart Stop hinges. Partial overlay styles have a larger 2 1/2" width reveal, use standard Smart Stop hinges, and are not recommended for stacking applications due to misalignment of door width with cabinets above.
- Cabinets with 3" wide face frames are not available in MDF door styles.
- Upper section on 90" tall has one full depth adjustable shelf.
- All top and bottom cross rails are 1 1/2" wide.
- Be sure to confirm a heat shield is built into your appliance by the manufacturer or install the heat shield included with your appliance. Heat shields are sold separately as an accessory.
- Depth can be reduced to a minimum of 12".
- For built-in appliance support, OCINSTALLKIT is included in 24" deep oven cabinets (see page 422 for details). Oven install kit will not be included when depth is modified.
- Oven cabinets feature an open back in cut-out area designed to improve field appliance installation.
- Maximum cut-out dimension will allow 1/4" reveal for doors and drawer fronts on full overlay and 1" for partial overlay for trim kit face clearance.

	A Frame Opening Height	B Cut-out Width		C Cut-out Height		Door Height (Upper Section)	
		Min.	Max.	Min.	Max.	Partial Overlay	Full Overlay
OCS278424DD	15"	21"	25 1/2"	27 3/4"	42 3/4"	16"	17 1/2"
OCS308424DD	15"	24"	28 1/2"	27 3/4"	42 3/4"	16"	17 1/2"
OCS338424DD	15"	27"	31 1/2"	27 3/4"	42 3/4"	16"	17 1/2"
OCS278724DD	18"	21"	25 1/2"	27 3/4"	42 3/4"	19"	20 1/2"
OCS308724DD	18"	24"	28 1/2"	27 3/4"	42 3/4"	19"	20 1/2"
OCS338724DD	18"	27"	31 1/2"	27 3/4"	42 3/4"	19"	20 1/2"
OCS279024DDAH	21"	21"	25 1/2"	27 3/4"	42 3/4"	22"	23 1/2"
OCS309024DDAH	21"	24"	28 1/2"	27 3/4"	42 3/4"	22"	23 1/2"
OCS339024DDAH	21"	27"	31 1/2"	27 3/4"	42 3/4"	22"	23 1/2"

	A Frame Opening Height	B Cut-out Width (standard)		B Cut-out Width (with ACS modification)			C Cut-out Height		Door Height (Upper Section)	
		Min.	Max.	Min.	Max.	Max. w/ Field Cut	Min.	Max.	Partial Overlay	Full Overlay
OCS308424DDN	15"	27"	28 1/2"	24"	27"	28 1/2"	27 3/4"	42 3/4"	16"	17 1/2"
OCS338424DDN	15"	30"	31 1/2"	27"	30"	31 1/2"	27 3/4"	42 3/4"	16"	17 1/2"
OCS278724DDN	18"	24"	25 1/2"	21"	24"	25 1/2"	27 3/4"	42 3/4"	19"	20 1/2"
OCS308724DDN	18"	27"	28 1/2"	24"	27"	28 1/2"	27 3/4"	42 3/4"	19"	20 1/2"
OCS338724DDN	18"	30"	31 1/2"	27"	30"	31 1/2"	27 3/4"	42 3/4"	19"	20 1/2"
OCS279024DDN	21"	24"	25 1/2"	21"	24"	25 1/2"	27 3/4"	42 3/4"	22"	23 1/2"
OCS309024DDN	21"	27"	28 1/2"	24"	27"	28 1/2"	27 3/4"	42 3/4"	22"	23 1/2"
OCS339024DDN	21"	30"	31 1/2"	27"	30"	31 1/2"	27 3/4"	42 3/4"	22"	23 1/2"

**Custom Modifications**

	ACD	ADDTK	AUTHL AUTHR	CBO	CCO	CFNTO	CFRMO	CND	DRT	DRWTK	EXBKL EXBKR	EXL EXR
•*		•	•	•	•		•	•		•	•	•
FB	FFDL FFDR	FPEB	FTK	FTKAV FTKRV	ID	INVFRM	MIP	RD	RECTKL RECTKR	RT	TD	
•		•	•	•			•	•	•			•
TKP	VTK	WLI										
•	•	•										

\*Only available on Narrow Stile (N) cabinets

**Construction Upgrades**

APC	ET	PE
•		•

**Door Options**

CG.TOP	DPSRR	MFO
	•	•

**SINGLE OVEN CABINET, DEEP  
DRAWER, 93" or 96" TALL, 24" DEEP**

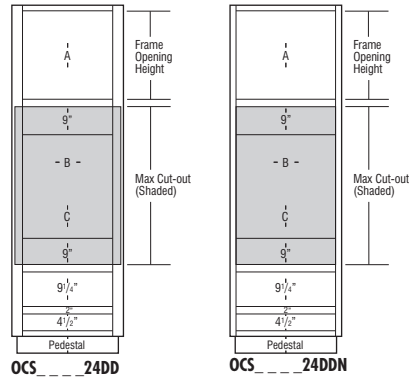
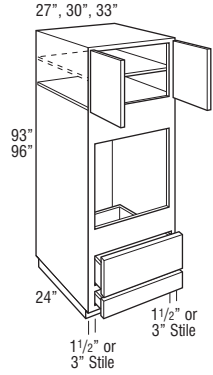

Model	Cubic Feet
OCS279324DD (AH or N)	41.3
OCS309324DD (AH or N)	45.7
OCS339324DD (AH or N)	50.0
OCS279624DD(N)	42.6
OCS309624DD(N)	47.1
OCS339624DD(N)	51.6

- AH represents upper section alignment with doors on 24" or 27" high cabinets.
- N represents Narrow Stile cabinets with 1 1/2" wide face frame side stiles and ACS modification availability (see page 46 for ACS specifications). Doors and drawer fronts have a consistent width reveal for full overlay (1/4") and partial overlay (1") and use standard Smart Stop hinges.
- On cabinets with 3" wide face frame side stiles, full overlay styles have a consistent 1/4" width frame reveal and use face mounted Smart Stop hinges. Partial overlay styles have a larger 2 1/2" width reveal, use standard Smart Stop hinges, and are not recommended for stacking applications due to misalignment of door width with cabinets above.
- Cabinets with 3" wide face frames are not available in MDF door styles.
- Includes adjustable shelves in upper section:  
93" tall - one shelf  
96" tall - two shelves
- All top and bottom cross rails are 1 1/2" wide.
- Be sure to confirm a heat shield is built into your appliance by the manufacturer or install the heat shield included with your appliance. Heat shields are sold separately as an accessory.
- Separate pedestal base included but packaged separately on 93" and 96" tall. Pedestal is designed to create a Recessed Left or Right ToeKick application during field installation, or can be centered. Pedestal must be covered with toeboard material.
- Depth can be reduced to a minimum of 12".
- For built-in appliance support, OCINSTALKIT is included in 24" deep oven cabinets (see page 422 for details). Oven install kit will not be included when depth is modified.
- Oven cabinets feature an open back in cut-out area designed to improve field appliance installation.
- Maximum cut-out dimension will allow 1/4" reveal for doors and drawer fronts on full overlay and 1" for partial overlay for trim kit face clearance.

	A Frame Opening Height	B Cut-out Width		C Cut-out Height		Door Height (Upper Section)	
		Min.	Max.	Min.	Max.	Partial Overlay	Full Overlay
OCS279324DDAH	24"	21"	25 1/2"	27 3/4"	42 3/4"	25"	26 1/2"
OCS309324DDAH	24"	24"	28 1/2"	27 3/4"	42 3/4"	25"	26 1/2"
OCS339324DDAH	24"	27"	31 1/2"	27 3/4"	42 3/4"	25"	26 1/2"
OCS279624DD	27"	21"	25 1/2"	27 3/4"	42 3/4"	28"	29 1/2"
OCS309624DD	27"	24"	28 1/2"	27 3/4"	42 3/4"	28"	29 1/2"
OCS339624DD	27"	27"	31 1/2"	27 3/4"	42 3/4"	28"	29 1/2"

	A Frame Opening Height	B Cut-out Width (standard)		B Cut-out Width (with ACS modification)			C Cut-out Height		Door Height (Upper Section)	
		Min.	Max.	Min.	Max.	Max. w/ Field Cut	Min.	Max.	Partial Overlay	Full Overlay
OCS279324DDN	24"	24"	25 1/2"	21"	24"	25 1/2"	27 3/4"	42 3/4"	25"	26 1/2"
OCS309324DDN	24"	27"	28 1/2"	24"	27"	28 1/2"	27 3/4"	42 3/4"	25"	26 1/2"
OCS339324DDN	24"	30"	31 1/2"	27"	30"	31 1/2"	27 3/4"	42 3/4"	25"	26 1/2"
OCS279624DDN	27"	24"	25 1/2"	21"	24"	25 1/2"	27 3/4"	42 3/4"	28"	29 1/2"
OCS309624DDN	27"	27"	28 1/2"	24"	27"	28 1/2"	27 3/4"	42 3/4"	28"	29 1/2"
OCS339624DDN	27"	30"	31 1/2"	27"	30"	31 1/2"	27 3/4"	42 3/4"	28"	29 1/2"

**Custom Modifications**

ACS	ADDTK	AUTHL AUTHR	CBO	CCO	CFNTO	CFRMO	CND	DRT	DRWTK	EXBKL EXBKR	EXL EXR
•*		•	•	•		•	•			•	•
FB	FFDL FFDR	FPEB	FTK	FTKAV FTKRV	ID	INVFRM	MIP	RD	RECTKL RECTKR	RT	TD
•		•					•	•	•		•
TKP	VTK	WLI									
		•									

\*Only available on Narrow Stile (N) cabinets

**Construction Upgrades**

APC	ET	PE
•		•

**Door Options**

CG.TOP	DPSRR	MFO
	•	•

**SINGLE OVEN CABINET, WARMING DRAWER, 84", 87", 90", 93", or 96" TALL, 24" DEEP**

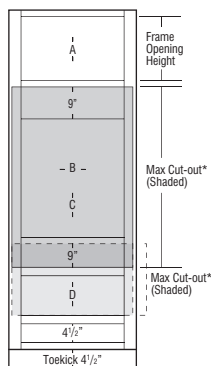
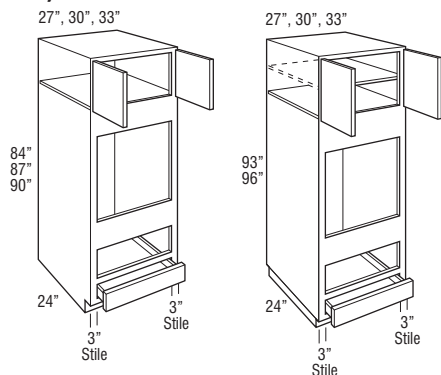

\*Minimum rail height between oven and warming drawer is 1 1/2"

Model	Cubic Feet	Model	Cubic Feet
OCS278424WD	37.4	OCS279324WDAH	41.3
OCS308424WD	41.3	OCS309324WDAH	45.7
OCS338424WD	45.2	OCS339324WDAH	50.0
OCS278724WD	38.7	OCS279624WD	42.6
OCS308724WD	42.8	OCS309624WD	47.1
OCS338724WD	46.8	OCS339624WD	51.6
OCS279024WDAH	40.0		
OCS309024WDAH	44.2		
OCS339024WDAH	48.4		

- AH represents upper section alignment with doors on 24" or 27" high cabinets.
- Includes adjustable shelves in upper section:  
90" and 93" tall - one shelf  
96" tall - two shelves
- Full overlay styles feature concealed face mount Smart Stop hinges.
- Cabinets with 3" wide face frames are not available in MDF door styles.
- All top and bottom cross rails are 1 1/2" wide.
- Be sure to confirm a heat shield is built into your appliance by the manufacturer or install the heat shield included with your appliance. Heat shields are sold separately as an accessory.
- Separate pedestal base included but packaged separately on 93" and 96" tall. Pedestal is designed to create a Recessed Left or Right Toe Kick application during field installation, or can be centered. Pedestal must be covered with toeboard material.
- Depth can be reduced to a minimum of 12".
- For built-in appliance support, OCINSTALLKIT is included in 24" deep oven cabinets (see page 422 for details). Oven install kit will not be included when depth is modified.
- Oven cabinets feature an open back in cut-out area designed to improve field appliance installation.

	A Frame Opening Height	B Cut-out Width		C Cut-out Height		D Warming Drawer Cut-out Height		Door Height (Upper Section)	
		Min.	Max.	Min.	Max.	Min.	Max.	Partial Overlay	Full Overlay
OCS278424WD	15"	21"	25 1/2"	27 3/4"	42 3/4"	9 1/4"	16 3/4"	16"	17 1/2"
OCS308424WD	15"	24"	28 1/2"	27 3/4"	42 3/4"	9 1/4"	16 3/4"	16"	17 1/2"
OCS338424WD	15"	27"	31 1/2"	27 3/4"	42 3/4"	9 1/4"	16 3/4"	16"	17 1/2"
OCS278724WD	18"	21"	25 1/2"	27 3/4"	42 3/4"	9 1/4"	16 3/4"	19"	20 1/2"
OCS308724WD	18"	24"	28 1/2"	27 3/4"	42 3/4"	9 1/4"	16 3/4"	19"	20 1/2"
OCS338724WD	18"	27"	31 1/2"	27 3/4"	42 3/4"	9 1/4"	16 3/4"	19"	20 1/2"
OCS279024WDAH	21"	21"	25 1/2"	27 3/4"	42 3/4"	9 1/4"	16 3/4"	22"	23 1/2"
OCS309024WDAH	21"	24"	28 1/2"	27 3/4"	42 3/4"	9 1/4"	16 3/4"	22"	23 1/2"
OCS339024WDAH	21"	27"	31 1/2"	27 3/4"	42 3/4"	9 1/4"	16 3/4"	22"	23 1/2"
OCS279324WDAH	24"	21"	25 1/2"	27 3/4"	42 3/4"	9 1/4"	16 3/4"	25"	26 1/2"
OCS309324WDAH	24"	24"	28 1/2"	27 3/4"	42 3/4"	9 1/4"	16 3/4"	25"	26 1/2"
OCS339324WDAH	24"	27"	31 1/2"	27 3/4"	42 3/4"	9 1/4"	16 3/4"	25"	26 1/2"
OCS279624WD	27"	21"	25 1/2"	27 3/4"	42 3/4"	9 1/4"	16 3/4"	28"	29 1/2"
OCS309624WD	27"	24"	28 1/2"	27 3/4"	42 3/4"	9 1/4"	16 3/4"	28"	29 1/2"
OCS339624WD	27"	27"	31 1/2"	27 3/4"	42 3/4"	9 1/4"	16 3/4"	28"	29 1/2"

Maximum cut-out dimension will allow 1/4" reveal for doors and drawer fronts on full overlay and 1" for partial overlay for trim kit face clearance.

**Custom Modifications**

ACS	ADDTK	AUTHL AUTHR	CBO	CCO	CFNTO	CFRMO	CND	DRT	DRWTK	EXBKL EXBKR	EXL EXR
		•	•	•		•	•		•*	•	•
FB	FFDL FFDR	FPEB	FTK	FTKAV FTKRV	ID	INVFRM	MIP	RD	RECTKL RECTKR	RT	TD
•		•	•*	•*	•		•	•	•		•
TKP	VTK	WLI									
•*	•*	•									

\*Not available on 93" and 96" tall

**Construction Upgrades**

APC	ET	PE
•		•

**Door Options**

CG.TOP	DPSRR	MFO
	•	•



**DOUBLE OVEN CABINET, 84", 87", or 90" TALL, 24" DEEP**

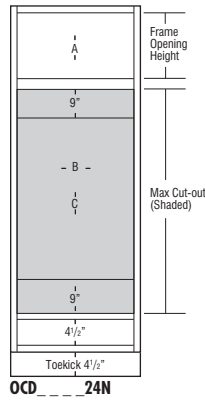
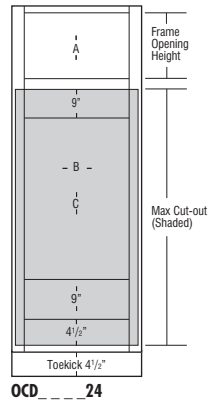
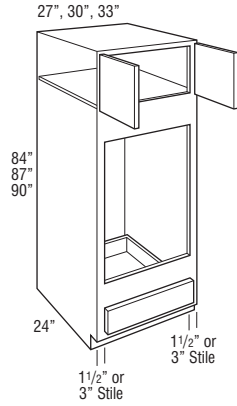

Model	Cubic Feet
OCD278424(N)	37.4
OCD308424(N)	41.3
OCD338424(N)	45.2
OCD278724(N)	38.7
OCD308724(N)	42.8
OCD338724(N)	46.8
OCD279024 (AH or N)	40.0
OCD309024 (AH or N)	44.2
OCD339024 (AH or N)	48.4

- AH represents upper section alignment with doors on 24" or 27" high cabinets.
- N represents Narrow Stile cabinets with 1 1/2" wide face frame side stiles and ACS modification availability (see page 46 for ACS specifications). Doors and drawer fronts have a consistent width reveal for full overlay (1/4") and partial overlay (1") and use standard Smart Stop hinges.
- On cabinets with 3" wide face frame side stiles, full overlay styles have a consistent 1/4" width frame reveal and use face mounted Smart Stop hinges. Partial overlay styles have a larger 2 1/2" width reveal, use standard Smart Stop hinges, and are not recommended for stacking applications due to misalignment of door width with cabinets above.
- Cabinets with 3" wide face frames are not available in MDF door styles.
- Upper section on 90" tall has one full depth adjustable shelf.
- All top and bottom cross rails are 1 1/2" wide.
- Be sure to confirm a heat shield is built into your appliance by the manufacturer or install the heat shield included with your appliance. Heat shields are sold separately as an accessory.
- Depth can be reduced to a minimum of 12".
- For built-in appliance support, OCINSTALLKIT is included in 24" deep oven cabinets (see page 422 for details). Oven install kit will not be included when depth is modified.
- Oven cabinets feature an open back in cut-out area designed to improve field appliance installation.
- Maximum cut-out dimension will allow 1/4" reveal for doors and drawer fronts on full overlay and 1" for partial overlay for trim kit face clearance.

	A Frame Opening Height	B Cut-out Width		C Cut-out Height		Door Height (Upper Section)	
		Min.	Max.	Min.	Max.	Partial Overlay	Full Overlay
OCD278424	15"	21"	25 1/2"	39"	60"	16"	17 1/2"
OCD308424	15"	24"	28 1/2"	39"	60"	16"	17 1/2"
OCD338424	15"	27"	31 1/2"	39"	60"	16"	17 1/2"
OCD278724	18"	21"	25 1/2"	39"	60"	19"	20 1/2"
OCD308724	18"	24"	28 1/2"	39"	60"	19"	20 1/2"
OCD338724	18"	27"	31 1/2"	39"	60"	19"	20 1/2"
OCD279024AH	21"	21"	25 1/2"	39"	60"	22"	23 1/2"
OCD309024AH	21"	24"	28 1/2"	39"	60"	22"	23 1/2"
OCD339024AH	21"	27"	31 1/2"	39"	60"	22"	23 1/2"

	A Frame Opening Height	B Cut-out Width (standard)		B Cut-out Width (with ACS modification)			C Cut-out Height		Door Height (Upper Section)	
		Min.	Max.	Min.	Max.	Max. w/ Field Cut	Min.	Max.	Partial Overlay	Full Overlay
OCD278424N	15"	24"	25 1/2"	21"	24"	25 1/2"	39"	54"	16"	17 1/2"
OCD308424N	15"	27"	28 1/2"	24"	27"	28 1/2"	39"	54"	16"	17 1/2"
OCD338424N	15"	30"	31 1/2"	27"	30"	31 1/2"	39"	54"	16"	17 1/2"
OCD278724N	18"	24"	25 1/2"	21"	24"	25 1/2"	39"	54"	19"	20 1/2"
OCD308724N	18"	27"	28 1/2"	24"	27"	28 1/2"	39"	54"	19"	20 1/2"
OCD338724N	18"	30"	31 1/2"	27"	30"	31 1/2"	39"	54"	19"	20 1/2"
OCD279024N	21"	24"	25 1/2"	21"	24"	25 1/2"	39"	54"	22"	23 1/2"
OCD309024N	21"	27"	28 1/2"	24"	27"	28 1/2"	39"	54"	22"	23 1/2"
OCD339024N	21"	30"	31 1/2"	27"	30"	31 1/2"	39"	54"	22"	23 1/2"

**Custom Modifications**

ACS	ADDTK	AUTHL AUTHR	CBO	CCO	CFNTO	CFRMO	CND	DRT	DRWTK	EXBKL EXBKR	EXL EXR
•*		•	•	•		•	•		•	•	•
FB	FFDL FFDR	FPEB	FTK	FTKAV FTKFV	ID	INVRM	MIP	RD	RECTKL RECTKR	RT	TD
•			•	•			•	•	•		•
TKP	VTK	WLI									
•	•	•									

\*Only available on Narrow Stile (N) cabinets

**Construction Upgrades**

APC	ET	PE
•		•

**Door Options**

CG.TOP	DPSRR	MFO
	•	•

**DOUBLE OVEN CABINET,  
93" or 96" TALL, 24" DEEP**

27", 30", 33"

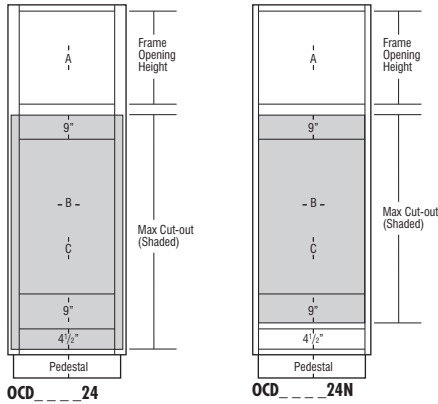
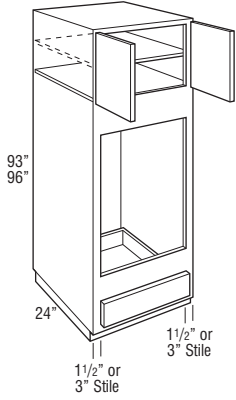

Model	Cubic Feet
<b>OCD279324 (AH or N)</b>	41.3
<b>OCD309324 (AH or N)</b>	45.7
<b>OCD339324 (AH or N)</b>	50.0
<b>OCD279624(N)</b>	42.6
<b>OCD309624(N)</b>	47.1
<b>OCD339624(N)</b>	51.6

- AH represents upper section alignment with doors on 24" or 27" high cabinets.
- N represents Narrow Stile cabinets with 1 1/2" wide face frame side stiles and ACS modification availability (see page 46 for ACS specifications). Doors and drawer fronts have a consistent width reveal for full overlay (1/4") and partial overlay (1") and use standard Smart Stop hinges.
- On cabinets with 3" wide face frame side stiles, full overlay styles have a consistent 1/4" width frame reveal and use face mounted Smart Stop hinges. Partial overlay styles have a larger 2 1/2" width reveal, use standard Smart Stop hinges, and are not recommended for stacking applications due to misalignment of door width with cabinets above.
- Cabinets with 3" wide face frames are not available in MDF door styles.
- Includes adjustable shelves in upper section:  
93" tall - one shelf  
96" tall - two shelves
- All top and bottom cross rails are 1 1/2" wide.
- Be sure to confirm a heat shield is built into your appliance by the manufacturer or install the heat shield included with your appliance. Heat shields are sold separately as an accessory.
- Separate pedestal base included but packaged separately on 93" and 96" tall. Pedestal is designed to create a Recessed Left or Right ToeKick application during field installation, or can be centered. Pedestal must be covered with toeboard material.
- Depth can be reduced to a minimum of 12".
- For built-in appliance support, OCINSTALLKIT is included in 24" deep oven cabinets (see page 422 for details). Oven install kit will not be included when depth is modified.
- Oven cabinets feature an open back in cut-out area designed to improve field appliance installation.
- Maximum cut-out dimension will allow 1/4" reveal for doors and drawer fronts on full overlay and 1" for partial overlay for trim kit face clearance.

	A Frame Opening Height	B Cut-out Width		C Cut-out Height		Door Height (Upper Section)	
		Min.	Max.	Min.	Max.	Partial Overlay	Full Overlay
OCD279324AH	24"	21"	25 1/2"	39"	60"	25"	26 1/2"
OCD309324AH	24"	24"	28 1/2"	39"	60"	25"	26 1/2"
OCD339324AH	24"	27"	31 1/2"	39"	60"	25"	26 1/2"
OCD279624	27"	21"	25 1/2"	39"	60"	28"	29 1/2"
OCD309624	27"	24"	28 1/2"	39"	60"	28"	29 1/2"
OCD339624	27"	27"	31 1/2"	39"	60"	28"	29 1/2"

	A Frame Opening Height	B Cut-out Width (standard)		B Cut-out Width (with ACS modification)			C Cut-out Height		Door Height (Upper Section)	
		Min.	Max.	Min.	Max.	Max. w/ Field Cut	Min.	Max.	Partial Overlay	Full Overlay
OCD279324N	24"	24"	25 1/2"	21"	24"	25 1/2"	39"	54"	25"	26 1/2"
OCD309324N	24"	27"	28 1/2"	24"	27"	28 1/2"	39"	54"	25"	26 1/2"
OCD339324N	24"	30"	31 1/2"	27"	30"	31 1/2"	39"	54"	25"	26 1/2"
OCD279624N	27"	24"	25 1/2"	21"	24"	25 1/2"	39"	54"	28"	29 1/2"
OCD309624N	27"	27"	28 1/2"	24"	27"	28 1/2"	39"	54"	28"	29 1/2"
OCD339624N	27"	30"	31 1/2"	27"	30"	31 1/2"	39"	54"	28"	29 1/2"

**Custom Modifications**

ACS	ADDTK	AUTHL AUTHR	CBO	CCO	CFNTO	CFRMO	CND	DRT	DRWTK	EXBKL EXBKR	EXL EXR
•*		•	•	•		•	•			•	•
FB	FFDL FFDR	FPEB	FTK	FTKAV FTKRV	ID	INVFRM	MIP	RD	RECTKL RECTKR	RT	TD
•		•			•		•	•	•		•
TKP	VTK	WLI									
		•									

\*Only available on Narrow Stile (N) cabinets

**Construction Upgrades**

APC	ET	PE
•		•

**Door Options**

CG.TOP	DPSRR	MFO
	•	•

**DOUBLE OVEN CABINET, DEEP DRAWER, 84", 87", or 90" TALL, 24" DEEP**

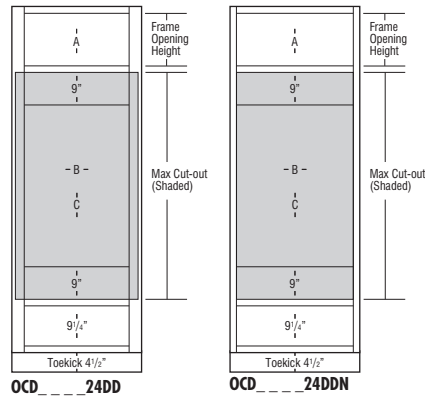
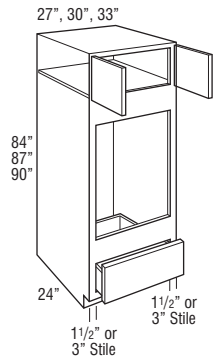

Model	Cubic Feet
OCD278424DD(N)	37.4
OCD308424DD(N)	41.3
OCD338424DD(N)	45.2
OCD278724DD(N)	38.7
OCD308724DD(N)	42.8
OCD338724DD(N)	46.8
OCD279024DD(N)	40.0
OCD309024DD(N)	44.2
OCD339024DD(N)	48.4

- N represents Narrow Stile cabinets with 1 1/2" wide face frame side stiles and ACS modification availability (see page 46 for ACS specifications). Doors and drawer fronts have a consistent width reveal for full overlay (1/4") and partial overlay (1") and use standard Smart Stop hinges.
- On cabinets with 3" wide face frame side stiles, full overlay styles have a consistent 1/4" width frame reveal and use face mounted Smart Stop hinges. Partial overlay styles have a larger 2 1/2" width reveal, use standard Smart Stop hinges, and are not recommended for stacking applications due to misalignment of door width with cabinets above.
- All top and bottom cross rails are 1 1/2" wide.
- Be sure to confirm a heat shield is built into your appliance by the manufacturer or install the heat shield included with your appliance. Heat shields are sold separately as an accessory.
- Depth can be reduced to a minimum of 12".
- For built-in appliance support, OCINSTALLKIT is included in 24" deep oven cabinets (see page 422 for details). Oven install kit will not be included when depth is modified.
- Oven cabinets feature an open back in cut-out area designed to improve field appliance installation.
- Maximum cut-out dimension will allow 1/4" reveal for doors and drawer fronts on full overlay and 1" for partial overlay for trim kit face clearance.

	A Frame Opening Height	B Cut-out Width		C Cut-out Height		Door Height (Upper Section)	
		Min.	Max.	Min.	Max.	Partial Overlay	Full Overlay
OCD278424DD	12"	21"	25 1/2"	37 1/4"	52 1/4"	13"	14 1/2"
OCD308424DD	12"	24"	28 1/2"	37 1/4"	52 1/4"	13"	14 1/2"
OCD338424DD	12"	27"	31 1/2"	37 1/4"	52 1/4"	13"	14 1/2"
OCD278724DD	15"	21"	25 1/2"	37 1/4"	52 1/4"	16"	17 1/2"
OCD308724DD	15"	24"	28 1/2"	37 1/4"	52 1/4"	16"	17 1/2"
OCD338724DD	15"	27"	31 1/2"	37 1/4"	52 1/4"	16"	17 1/2"
OCD279024DD	18"	21"	25 1/2"	37 1/4"	52 1/4"	19"	20 1/2"
OCD309024DD	18"	24"	28 1/2"	37 1/4"	52 1/4"	19"	20 1/2"
OCD339024DD	18"	27"	31 1/2"	37 1/4"	52 1/4"	19"	20 1/2"

	A Frame Opening Height	B Cut-out Width (standard)		B Cut-out Width (with ACS modification)			C Cut-out Height		Door Height (Upper Section)	
		Min.	Max.	Min.	Max.	Max. w/ Field Cut	Min.	Max.	Partial Overlay	Full Overlay
OCD308424DDN	12"	27"	28 1/2"	24"	27"	28 1/2"	37 1/4"	52 1/4"	13"	14 1/2"
OCD338424DDN	12"	30"	31 1/2"	27"	30"	31 1/2"	37 1/4"	52 1/4"	13"	14 1/2"
OCD278724DDN	15"	24"	25 1/2"	21"	24"	25 1/2"	37 1/4"	52 1/4"	16"	17 1/2"
OCD308724DDN	15"	27"	28 1/2"	24"	27"	28 1/2"	37 1/4"	52 1/4"	16"	17 1/2"
OCD338724DDN	15"	30"	31 1/2"	27"	30"	31 1/2"	37 1/4"	52 1/4"	16"	17 1/2"
OCD279024DDN	18"	24"	25 1/2"	21"	24"	25 1/2"	37 1/4"	52 1/4"	19"	20 1/2"
OCD309024DDN	18"	27"	28 1/2"	24"	27"	28 1/2"	37 1/4"	52 1/4"	19"	20 1/2"
OCD339024DDN	18"	30"	31 1/2"	27"	30"	31 1/2"	37 1/4"	52 1/4"	19"	20 1/2"

**Custom Modifications**

ACS	ADDTK	AUTHL AUTHR	CBO	CCO	CFNTO	CFRMO	CND	DRT	DRWTK	EXBKL EXBKR	EXL EXR
•*		•	•	•		•	•		•*	•	•
FB	FFDL FFDR	FPEB	FTK	FTKAV FTKVF	ID	INVFRM	MIP	RD	RECTKL RECTKR	RT	TD
•		•	•	•	•		•	•	•		•▲
TKP	VTK	WLI									
•	•	•									

\*Only available on Narrow Stile (N) cabinets •Not available on 87" tall ▲Not available on 84" tall

**Construction Upgrades**

APC	ET	PE
•		•

**Door Options**

CG.TOP	DPSRR	MFO
	•	•

**DOUBLE OVEN CABINET, DEEP DRAWER, 93" or 96" TALL, 24" DEEP**

27", 30", 33"

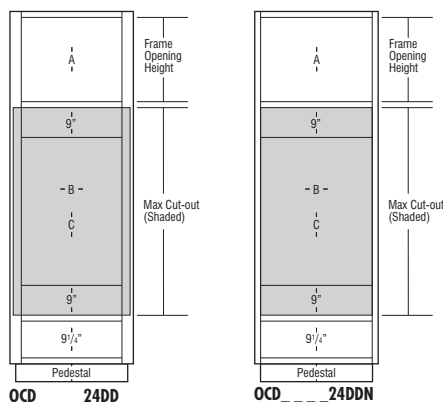
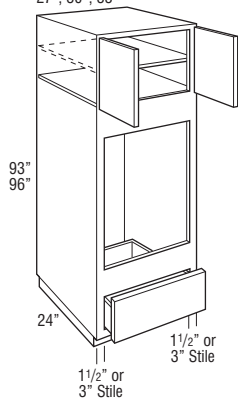

Model	Cubic Feet
OCD279324DD (AH or N)	41.3
OCD309324DD (AH or N)	45.7
OCD339324DD (AH or N)	50.0
OCD279624DD (AH or N)	42.6
OCD309624DD (AH or N)	47.1
OCD339624DD (AH or N)	51.6

- AH represents upper section alignment with doors on 24" or 27" high cabinets.
- N represents Narrow Stile cabinets with 1 1/2" wide face frame side stiles and ACS modification availability (see page 46 for ACS specifications). Doors and drawer fronts have a consistent width reveal for full overlay (1/4") and partial overlay (1") and use standard Smart Stop hinges.
- On cabinets with 3" wide face frame side stiles, full overlay styles have a consistent 1/4" width frame reveal and use face mounted Smart Stop hinges. Partial overlay styles have a larger 2 1/2" width reveal, use standard Smart Stop hinges, and are not recommended for stacking applications due to misalignment of door width with cabinets above.
- All top and bottom cross rails are 1 1/2" wide.
- Be sure to confirm a heat shield is built into your appliance by the manufacturer or install the heat shield included with your appliance. Heat shields are sold separately as an accessory.
- Separate pedestal base included but packaged separately on 93" and 96" tall. Pedestal is designed to create a Recessed Left or Right Toe Kick application during field installation, or can be centered. Pedestal must be covered with toeboard material.
- One full depth adjustable shelf included, but packaged separately.
- Depth can be reduced to a minimum of 12".
- For built-in appliance support, OCINSTALLKIT is included in 24" deep oven cabinets (see page 422 for details). Oven install kit will not be included when depth is modified.
- Oven cabinets feature an open back in cut-out area designed to improve field appliance installation.
- Maximum cut-out dimension will allow 1/4" reveal for doors and drawer fronts on full overlay and 1" for partial overlay for trim kit face clearance.

	A Frame Opening Height	B Cut-out Width		C Cut-out Height		Door Height (Upper Section)	
		Min.	Max.	Min.	Max.	Partial Overlay	Full Overlay
OCD279324DDAH	21"	21"	25 1/2"	37 1/4"	52 1/4"	22"	23 1/2"
OCD309324DDAH	21"	24"	28 1/2"	37 1/4"	52 1/4"	22"	23 1/2"
OCD339324DDAH	21"	27"	31 1/2"	37 1/4"	52 1/4"	22"	23 1/2"
OCD279624DDAH	24"	21"	25 1/2"	37 1/4"	52 1/4"	25"	26 1/2"
OCD309624DDAH	24"	24"	28 1/2"	37 1/4"	52 1/4"	25"	26 1/2"
OCD339624DDAH	24"	27"	31 1/2"	37 1/4"	52 1/4"	25"	26 1/2"

	A Frame Opening Height	B Cut-out Width (standard)		B Cut-out Width (with ACS modification)			C Cut-out Height		Door Height (Upper Section)	
		Min.	Max.	Min.	Max.	Max. w/ Field Cut	Min.	Max.	Partial Overlay	Full Overlay
OCD279324DDN	21"	24"	25 1/2"	21"	24"	25 1/2"	37 1/4"	52 1/4"	22"	23 1/2"
OCD309324DDN	21"	27"	28 1/2"	24"	27"	28 1/2"	37 1/4"	52 1/4"	22"	23 1/2"
OCD339324DDN	21"	30"	31 1/2"	27"	30"	31 1/2"	37 1/4"	52 1/4"	22"	23 1/2"
OCD279624DDN	24"	24"	25 1/2"	21"	24"	25 1/2"	37 1/4"	52 1/4"	25"	26 1/2"
OCD309624DDN	24"	27"	28 1/2"	24"	27"	28 1/2"	37 1/4"	52 1/4"	25"	26 1/2"
OCD339624DDN	24"	30"	31 1/2"	27"	30"	31 1/2"	37 1/4"	52 1/4"	25"	26 1/2"

**Custom Modifications**

ACS	ADDTK	AUTHL AUTHR	CBO	CCO	CFNTO	CFRMO	CND	DRT	DRWTK	EXBKL EXBKR	EXL EXR
•*		•	•	•		•	•			•	•
FB	FFDL FFDR	FPEB	FTK	FTKAV FTKFV	ID	INVFRM	MIP	RD	RECTKL RECTKR	RT	TD
•		•			•		•	•	•		•
TKP	VTK	WLI									
		•									

\*Only available on Narrow Stile (N) cabinets

**Construction Upgrades**

APC	ET	PE
•		•

**Door Options**

CG.TOP	DPSRR	MFO
	•	•

**DOUBLE OVEN CABINET, WARMING DRAWER, 84", 87", 90", 93", or 96" TALL, 24" DEEP**

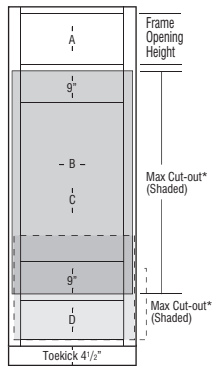
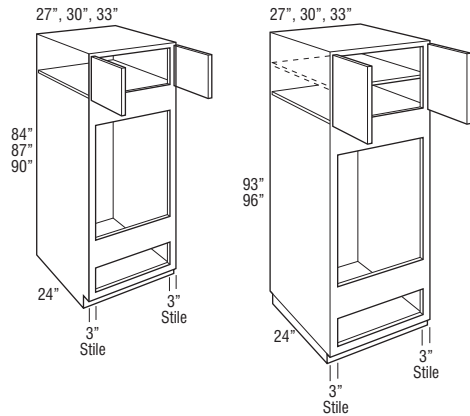

\*Minimum rail height between oven and warming drawer is 1 1/2"

Model	Cubic Feet
OCD278424WD	37.4
OCD308424WD	41.3
OCD338424WD	45.2
OCD278724WD	38.7
OCD308724WD	42.8
OCD338724WD	46.8
OCD279024WD	40.0
OCD309024WD	44.2
OCD339024WD	48.4
OCD279324WDAH	41.3
OCD309324WDAH	45.7
OCD339324WDAH	50.0
OCD279624WDAH	42.6
OCD309624WDAH	47.1
OCD339624WDAH	51.6

- AH represents upper section alignment with doors on 24" or 27" high cabinets.
- Includes one adjustable shelf in upper section of 93" and 96" tall.
- Full overlay styles feature concealed face mount Smart Stop hinges.
- All top and bottom cross rails are 1 1/2" wide.
- Be sure to confirm a heat shield is built into your appliance by the manufacturer or install the heat shield included with your appliance. Heat shields are sold separately as an accessory.
- Separate pedestal base included but packaged separately on 93" and 96" tall. Pedestal is designed to create a Recessed Left or Right Toekick application during field installation, or can be centered. Pedestal must be covered with toeboard material.
- Depth can be reduced to a minimum of 6". For depths of 6"-8", cabinet will not include toekick/pedestal.
- For built-in appliance support, OCINSTALLKIT is included in 24" deep oven cabinets (see page 422 for details). Oven install kit will not be included when depth is modified.
- Oven cabinets feature an open back in cut-out area designed to improve field appliance installation.

	A Frame Opening Height	B Cut-out Width		C Cut-out Height		D Warming Drawer Cut-out Height		Door Height (Upper Section)	
		Min.	Max.	Min.	Max.	Min.	Max.	Partial Overlay	Full Overlay
OCD278424WD	12"	21"	25 1/2"	37 1/4"	52 1/4"	9 1/4"	16 3/4"	13"	14 1/2"
OCD308424WD	12"	24"	28 1/2"	37 1/4"	52 1/4"	9 1/4"	16 3/4"	13"	14 1/2"
OCD338424WD	12"	27"	31 1/2"	37 1/4"	52 1/4"	9 1/4"	16 3/4"	13"	14 1/2"
OCD278724WD	15"	21"	25 1/2"	37 1/4"	52 1/4"	9 1/4"	16 3/4"	16"	17 1/2"
OCD308724WD	15"	24"	28 1/2"	37 1/4"	52 1/4"	9 1/4"	16 3/4"	16"	17 1/2"
OCD338724WD	15"	27"	31 1/2"	37 1/4"	52 1/4"	9 1/4"	16 3/4"	16"	17 1/2"
OCD279024WD	18"	21"	25 1/2"	37 1/4"	52 1/4"	9 1/4"	16 3/4"	19"	20 1/2"
OCD309024WD	18"	24"	28 1/2"	37 1/4"	52 1/4"	9 1/4"	16 3/4"	19"	20 1/2"
OCD339024WD	18"	27"	31 1/2"	37 1/4"	52 1/4"	9 1/4"	16 3/4"	19"	20 1/2"
OCD279324WDAH	21"	21"	25 1/2"	37 1/4"	52 1/4"	9 1/4"	16 3/4"	22"	23 1/2"
OCD309324WDAH	21"	24"	28 1/2"	37 1/4"	52 1/4"	9 1/4"	16 3/4"	22"	23 1/2"
OCD339324WDAH	21"	27"	31 1/2"	37 1/4"	52 1/4"	9 1/4"	16 3/4"	22"	23 1/2"
OCD279624WDAH	24"	21"	25 1/2"	37 1/4"	52 1/4"	9 1/4"	16 3/4"	25"	26 1/2"
OCD309624WDAH	24"	24"	28 1/2"	37 1/4"	52 1/4"	9 1/4"	16 3/4"	25"	26 1/2"
OCD339624WDAH	24"	27"	31 1/2"	37 1/4"	52 1/4"	9 1/4"	16 3/4"	25"	26 1/2"

Maximum cut-out dimension will allow 1/4" reveal for doors and drawer fronts on full overlay and 1" for partial overlay for trim kit face clearance.

**Custom Modifications**

ACS	ADDTK	AUTHL AUTHR	CBO	CCO	CFNTO	CFRMO	CND	DRT	DRWTK	EXBKL EXBKR	EXL EXR
		•	•*	•		•			•*	•	•
FB	FFDL FFDR	FPEB	FTK	FTKAV FTKRV	ID	INVFRM	MIP	RD	RECTKL RECTKR	RT	TD
•		•	•*	•*	•		•	•	•		•▲
TKP	VTK	WLI									
•*	•*	•									

\*Not available on 84", 87", and 90" tall \*Not available on 93" and 96" tall ▲Not available on 84" tall

**Construction Upgrades**

APC	ET	PE
•		•

**Door Options**

CG.TOP	DPSRR	MFO
	•	•

**DOUBLE OVEN CABINET, WARMING DRAWER with EXTENDED OPENING, 84", 87", 90", 93", or 96" TALL, 24" DEEP**

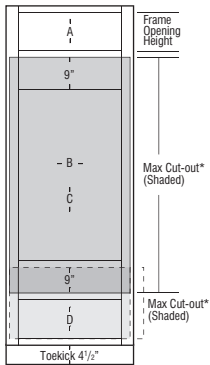
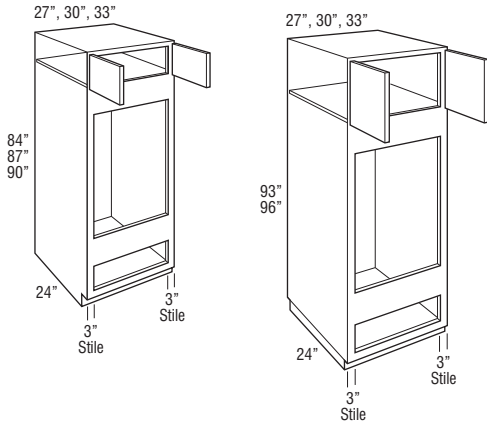

\*Minimum rail height between oven and warming drawer is 1 1/2"

Model	Cubic Feet	Model	Cubic Feet
OCD278424WDE	37.4	OCD279324WDE	41.3
OCD308424WDE	41.3	OCD309324WDE	45.7
OCD338424WDE	45.2	OCD339324WDE	50.0
OCD278724WDE	38.7	OCD279624WDEAH	42.6
OCD308724WDE	42.8	OCD309624WDEAH	47.1
OCD338724WDE	46.8	OCD339624WDEAH	51.6
OCD279024WDE	40.0		
OCD309024WDE	44.2		
OCD339024WDE	48.4		

- AH represents upper section alignment with doors on 24" or 27" high cabinets.
- Includes one adjustable shelf in upper section of 93" and 96" tall.
- Full overlay styles feature concealed face mount Smart Stop hinges.
- All top and bottom cross rails are 1 1/2" wide.
- Standard interior (matching interior not required).
- Be sure to confirm a heat shield is built into your appliance by the manufacturer or install the heat shield included with your appliance. Heat shields are sold separately as an accessory.
- Separate pedestal base included but packaged separately on 93" and 96" tall. Pedestal is designed to create a Recessed Left or Right Toe Kick application during field installation, or can be centered. Pedestal must be covered with toeboard material.
- Depth can be reduced to a minimum of 6". For depths of 6"-8", cabinet will not include toe kick/pedestal.
- For built-in appliance support, OCINSTALLKIT is included in 24" deep oven cabinets (see page 422 for details). Oven install kit will not be included when depth is modified.
- Oven cabinets feature an open back in cut-out area designed to improve field appliance installation.

	A Frame Opening Height	B Cut-out Width		C Cut-out Height		D Warming Drawer Cut-out Height		Door Height (Upper Section)	
		Min.	Max.	Min.	Max.	Min.	Max.	Partial Overlay	Full Overlay
OCD278424WDE	9"	21"	25 1/2"	40 1/4"	55 1/4"	9 1/4"	16 3/4"	10"	11 1/2"
OCD308424WDE	9"	24"	28 1/2"	40 1/4"	55 1/4"	9 1/4"	16 3/4"	10"	11 1/2"
OCD338424WDE	9"	27"	31 1/2"	40 1/4"	55 1/4"	9 1/4"	16 3/4"	10"	11 1/2"
OCD278724WDE	12"	21"	25 1/2"	40 1/4"	55 1/4"	9 1/4"	16 3/4"	13"	14 1/2"
OCD308724WDE	12"	24"	28 1/2"	40 1/4"	55 1/4"	9 1/4"	16 3/4"	13"	14 1/2"
OCD338724WDE	12"	27"	31 1/2"	40 1/4"	55 1/4"	9 1/4"	16 3/4"	13"	14 1/2"
OCD279024WDE	15"	21"	25 1/2"	40 1/4"	55 1/4"	9 1/4"	16 3/4"	16"	17 1/2"
OCD309024WDE	15"	24"	28 1/2"	40 1/4"	55 1/4"	9 1/4"	16 3/4"	16"	17 1/2"
OCD339024WDE	15"	27"	31 1/2"	40 1/4"	55 1/4"	9 1/4"	16 3/4"	16"	17 1/2"
OCD279324WDE	18"	21"	25 1/2"	40 1/4"	55 1/4"	9 1/4"	16 3/4"	19"	20 1/2"
OCD309324WDE	18"	24"	28 1/2"	40 1/4"	55 1/4"	9 1/4"	16 3/4"	19"	20 1/2"
OCD339324WDE	18"	27"	31 1/2"	40 1/4"	55 1/4"	9 1/4"	16 3/4"	19"	20 1/2"
OCD279624WDEAH	21"	21"	25 1/2"	40 1/4"	55 1/4"	9 1/4"	16 3/4"	22"	23 1/2"
OCD309624WDEAH	21"	24"	28 1/2"	40 1/4"	55 1/4"	9 1/4"	16 3/4"	22"	23 1/2"
OCD339624WDEAH	21"	27"	31 1/2"	40 1/4"	55 1/4"	9 1/4"	16 3/4"	22"	23 1/2"

Maximum cut-out dimension will allow 1/4" reveal for doors and drawer fronts on full overlay and 1" for partial overlay for trim kit face clearance.

**Custom Modifications**

ACS	ADDTK	AUTHL AUTHR	CBO	CCO	CFNTO	CFRMO	CND	DRT	DRWTK	EXBKL EXBKR	EXL EXR
		•			•	•			•+	•	•
FB	FFDL FFDR	FPEB	FTK	FTKAV FTKRV	ID	INVRM	MIP	RD	RECTKL RECTKR	RT	TD
•		•	•*	•*	•		•	•	•+		•▲
TKP	VTK	WLI									
•*	•*	•									

\*Not available on 93" and 96" tall \*Not available on 96" tall ▲Not available on 84", 87", 90", and 93" tall

**Construction Upgrades**

APC	ET	PE
•		•

**Door Options**

CG.TOP	DPSRR	MFO
	•	•

**TALL BUILT-IN MICROWAVE CABINET,  
84", 87", 90", 93", or 96" TALL**

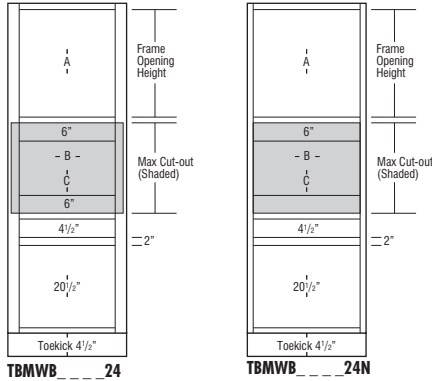
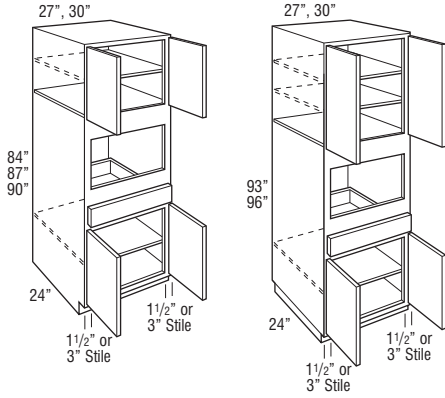

Model	Cubic Feet	Model	Cubic Feet
TBMWB278424 (AH or N)	37.4	TBMWB279324(N)	41.3
TBMWB308424 (AH or N)	41.3	TBMWB309324(N)	45.7
TBMWB278724(N)	38.7	TBMWB279624(N)	42.6
TBMWB308724(N)	42.8	TBMWB309624(N)	47.1
TBMWB279024(N)	40.0		
TBMWB309024(N)	44.2		

- AH represents upper section alignment with doors on 24" or 27" high cabinets.
- N represents Narrow Stile cabinets with 1 1/2" wide face frame side stiles and ACS modification availability (see page 46 for ACS specifications). Doors and drawer fronts have a consistent width reveal for full overlay (1/4") and partial overlay (1") and use standard Smart Stop hinges.
- On cabinets with 3" wide face frame side stiles, doors and drawer fronts have a consistent width reveal for full overlay (1/4") and partial overlay (1") and use face mount Smart Stop hinges. When CG is specified, face frame will be visible through door if used with a translucent art or textured glass design.
- Cabinets with 3" wide face frames are not available in MDF door styles.
- Includes adjustable shelves in upper section:  
84" tall - one shelf  
87"-93" tall - two shelves  
96" tall - three shelves
- Base section will utilize a full depth shelf.
- All top and bottom cross rails are 1 1/2" wide.
- All toe kick areas are 4 1/2" high.
- Separate pedestal base included but packaged separately on 93" and 96" tall. Pedestal is designed to create a Recessed Left or Right Toe kick application during field installation, or can be centered. Pedestal must be covered with toeboard material.
- Includes OCINSTALKIT for microwave installation.
- Maximum cut-out dimension will allow 1/4" reveal for doors and drawer fronts on full overlay and 1" for partial overlay for trim kit face clearance.

	A Frame Opening Height	B Cut-out Width		C Cut-out Height		Door Height (Upper Section)	
		Min.	Max.	Min.	Max.	Partial Overlay	Full Overlay
TBMWB278424AH	24"	21"	25 1/2"	13 1/2"	22 1/2"	25"	27 1/2"
TBMWB308424AH	24"	24"	28 1/2"	13 1/2"	22 1/2"	25"	27 1/2"
TBMWB278724	27"	21"	25 1/2"	13 1/2"	22 1/2"	28"	29 1/2"
TBMWB308724	27"	24"	28 1/2"	13 1/2"	22 1/2"	28"	29 1/2"
TBMWB279024	30"	21"	25 1/2"	13 1/2"	22 1/2"	31"	32 1/2"
TBMWB309024	30"	24"	28 1/2"	13 1/2"	22 1/2"	31"	32 1/2"
TBMWB279324	33"	21"	25 1/2"	13 1/2"	22 1/2"	34"	35 1/2"
TBMWB309324	33"	24"	28 1/2"	13 1/2"	22 1/2"	34"	35 1/2"
TBMWB279624	36"	21"	25 1/2"	13 1/2"	22 1/2"	37"	38 1/2"
TBMWB309624	36"	24"	28 1/2"	13 1/2"	22 1/2"	37"	38 1/2"

	A Frame Opening Height	B Cut-out Width (standard)		B Cut-out Width (with ACS modification)			C Cut-out Height		Door Height (Upper Section)	
		Min.	Max.	Min.	Max.	Max. w/ Field Cut	Min.	Max.	Partial Overlay	Full Overlay
TBMWB278424N	24"	24"	25 1/2"	21"	24"	25 1/2"	13 1/2"	22 1/2"	25"	26 1/2"
TBMWB308424N	24"	27"	28 1/2"	24"	27"	28 1/2"	13 1/2"	22 1/2"	25"	26 1/2"
TBMWB278724N	27"	24"	25 1/2"	21"	24"	25 1/2"	13 1/2"	22 1/2"	28"	29 1/2"
TBMWB308724N	27"	27"	28 1/2"	24"	27"	28 1/2"	13 1/2"	22 1/2"	28"	29 1/2"
TBMWB279024N	30"	24"	25 1/2"	21"	24"	25 1/2"	13 1/2"	22 1/2"	31"	32 1/2"
TBMWB309024N	30"	27"	28 1/2"	24"	27"	28 1/2"	13 1/2"	22 1/2"	31"	32 1/2"
TBMWB279324N	33"	24"	25 1/2"	21"	24"	25 1/2"	13 1/2"	22 1/2"	34"	35 1/2"
TBMWB309324N	33"	27"	28 1/2"	24"	27"	28 1/2"	13 1/2"	22 1/2"	34"	35 1/2"
TBMWB279624N	36"	24"	25 1/2"	21"	24"	25 1/2"	13 1/2"	22 1/2"	37"	38 1/2"
TBMWB309624N	36"	27"	28 1/2"	24"	27"	28 1/2"	13 1/2"	22 1/2"	37"	38 1/2"

**Custom Modifications**

ACS	ADDTK	AUTHL AUTHR	CBO	CCO	CFNTO	CFRMO	CND	DRT	DRWTK	EXBKL EXBKR	EXL EXR
•*		•	•	•		•	•		•*	•	•
FB	FFDL FFDR	FPEB	FTK	FTKAV FTKRV	ID	INVRM	MIP	RD	RECTKL RECTKR	RT	TD
•		•	•*	•*			•	•	•	•	•*
TKP	VTK	WLI									
•*		•									

\*Only available on Narrow Stile (N) cabinets \* Not available on 93" and 96" tall \* Not available on 90", 93", and 96" tall

**Construction Upgrades**

APC	ET	PE
•		•

**Door Options**

CG.TOP	DPSRR	MFO
•	•	•

**OVEN MICROWAVE CABINET,  
84", 87", or 90" TALL, 24" DEEP**

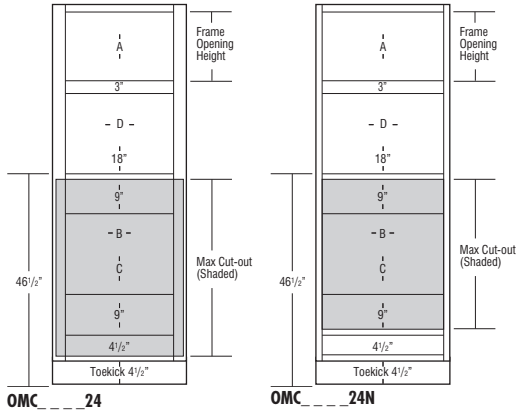
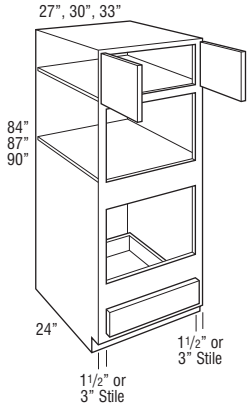

Model	Cubic Feet
OMC278424(N)	37.4
OMC308424(N)	41.3
OMC338424(N)	45.2
OMC278724(N)	38.7
OMC308724(N)	42.8
OMC338724(N)	46.8
OMC279024 (AH or N)	40.0
OMC309024 (AH or N)	44.2
OMC339024 (AH or N)	48.4

- AH represents upper section alignment with doors on 24" or 27" high cabinets.
- N represents Narrow Stile cabinets with 1 1/2" wide face frame side stiles and ACS modification availability (see page 46 for ACS specifications). Doors and drawer fronts have a consistent width reveal for full overlay (1/4") and partial overlay (1") and use standard Smart Stop hinges.
- On cabinets with 3" wide face frame side stiles, full overlay styles have a consistent 1/4" width frame reveal and use face mounted Smart Stop hinges. Partial overlay styles have a larger 2 1/2" width reveal, use standard Smart Stop hinges, and are not recommended for stacking applications due to misalignment of door width with cabinets above.
- Cabinets with 3" wide face frames are not available in MDF door styles.
- Upper section on 90" tall has one full depth adjustable shelf.
- Designed for use with separate built-in microwave above, built-in oven below. For built-in double ovens, see pages 287-292.
- All top and bottom cross rails are 1 1/2" wide.
- All toekick areas are 4 1/2" high.
- Be sure to confirm a heat shield is built into your appliance by the manufacturer or install the heat shield included with your appliance. Heat shields are sold separately as an accessory.
- Depth can be reduced to a minimum of 12".
- For built-in appliance support, OCINSTALLKIT is included in 24" deep oven cabinets (see page 422 for details). Oven install kit will not be included when depth is modified.
- Maximum cut-out dimension will allow 1/4" reveal for doors and drawer fronts on full overlay and 1" for partial overlay for trim kit face clearance.

	A Frame Opening Height	B Cut-out Width		C Cut-out Height		D Frame Opening Width	Door Height (Upper Section)	
		Min.	Max.	Min.	Max.		Partial Overlay	Full Overlay
OMC278424	15"	21"	25 1/2"	18"	39"	21"	16"	17 1/2"
OMC308424	15"	24"	28 1/2"	18"	39"	24"	16"	17 1/2"
OMC338424	15"	27"	31 1/2"	18"	39"	27"	16"	17 1/2"
OMC278724	18"	21"	25 1/2"	18"	39"	21"	19"	20 1/2"
OMC308724	18"	24"	28 1/2"	18"	39"	24"	19"	20 1/2"
OMC338724	18"	27"	31 1/2"	18"	39"	27"	19"	20 1/2"
OMC279024AH	21"	21"	25 1/2"	18"	39"	21"	22"	23 1/2"
OMC309024AH	21"	24"	28 1/2"	18"	39"	24"	22"	23 1/2"
OMC339024AH	21"	27"	31 1/2"	18"	39"	27"	22"	23 1/2"

	A Frame Opening Height	B Cut-out Width (standard)		B Cut-out Width (with ACS modification)			C Cut-out Height		Door Height (Upper Section)	
		Min.	Max.	Min.	Max.	Max. w/ Field Cut	Min.	Max.	Partial Overlay	Full Overlay
OMC278424N	15"	24"	25 1/2"	21"	24"	25 1/2"	18"	33"	16"	17 1/2"
OMC308424N	15"	27"	28 1/2"	24"	27"	28 1/2"	18"	33"	16"	17 1/2"
OMC338424N	15"	30"	31 1/2"	27"	30"	31 1/2"	18"	33"	16"	17 1/2"
OMC278724N	18"	24"	25 1/2"	21"	24"	25 1/2"	18"	33"	19"	20 1/2"
OMC308724N	18"	27"	28 1/2"	24"	27"	28 1/2"	18"	33"	19"	20 1/2"
OMC338724N	18"	30"	31 1/2"	27"	30"	31 1/2"	18"	33"	19"	20 1/2"
OMC279024N	21"	24"	25 1/2"	21"	24"	25 1/2"	18"	33"	22"	23 1/2"
OMC309024N	21"	27"	28 1/2"	24"	27"	28 1/2"	18"	33"	22"	23 1/2"
OMC339024N	21"	30"	31 1/2"	27"	30"	31 1/2"	18"	33"	22"	23 1/2"

**Custom Modifications**

	ACS	ADDTK	AUTHL AUTHR	CBO	CCO	CFNTO	CFRMO	CND	DRT	DRWTK	EXBKL EXBKR	EXL EXR
•*			•	•	•		•	•		•	•	•
FB	FFDL FFDR	FPEB	FTK	FTKAV FTKRV	ID	INVFRM	MIP	RD	RECTKL RECTKR	RT	TD	
•			•	•	•		•	•	•			•
TKP	VTK	WLI										
•	•	•										

\*Only available on Narrow Stile (N) cabinets

**Construction Upgrades**

APC	ET	PE
•		•

**Door Options**

CG.TOP	DPSRR	MFO
	•	•



**OVEN MICROWAVE CABINET,  
93" or 96" TALL, 24" DEEP**

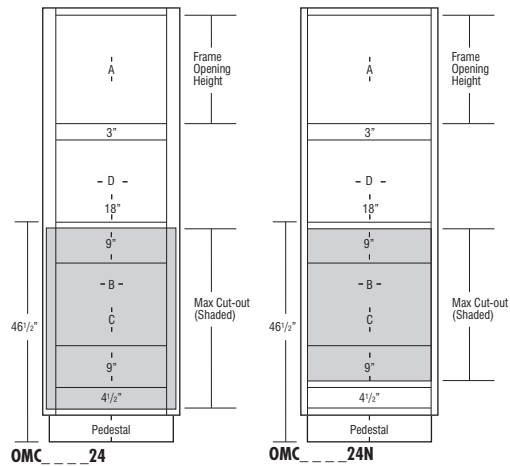
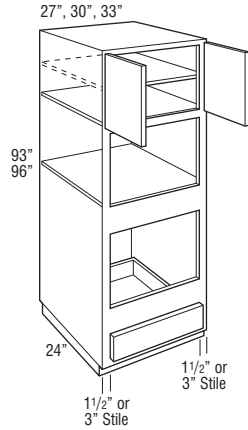

Model	Cubic Feet
OMC279324 (AH or N)	41.3
OMC309324 (AH or N)	45.7
OMC339324 (AH or N)	50.0
OMC279624(N)	42.6
OMC309624(N)	47.1
OMC339624(N)	51.6

- AH represents upper section with doors on 24" or 27" high cabinets.
- N represents Narrow Stile cabinets with 1 1/2" wide face frame side stiles and ACS modification availability (see page 46 for ACS specifications). Doors and drawer fronts have a consistent width reveal for full overlay (1/4") and partial overlay (1") and use standard Smart Stop hinges.
- On cabinets with 3" wide face frame side stiles, full overlay styles have a consistent 1/4" width frame reveal and use face mounted Smart Stop hinges. Partial overlay styles have a larger 2 1/2" width reveal, use standard Smart Stop hinges, and are not recommended for stacking applications due to misalignment of door width with cabinets above.
- Cabinets with 3" wide face frames are not available in MDF door styles.
- Includes adjustable shelves in upper section:  
93" tall - one shelf  
96" tall - two shelves
- Designed for use with separate built-in microwave above, built-in oven below. For built-in double ovens, see pages 287-292.
- All top and bottom cross rails are 1 1/2" wide.
- All toekick areas are 4 1/2" high.
- Be sure to confirm a heat shield is built into your appliance by the manufacturer or install the heat shield included with your appliance. Heat shields are sold separately as an accessory.
- Separate pedestal base included but packaged separately on 93" and 96" tall. Pedestal is designed to create a Recessed Left or Right ToeKick application during field installation, or can be centered. Pedestal must be covered with toeboard material.
- Depth can be reduced to a minimum of 12".
- For built-in appliance support, OCINSTALLKIT is included in 24" deep oven cabinets (see page 422 for details). Oven install kit will not be included when depth is modified.
- Maximum cut-out dimension will allow 1/4" reveal for doors and drawer fronts on full overlay and 1" for partial overlay for trim kit face clearance.

	A Frame Opening Height	B Cut-out Width		C Cut-out Height		D Frame Opening Width	Door Height (Upper Section)	
		Min.	Max.	Min.	Max.		Partial Overlay	Full Overlay
OMC279324AH	24"	21"	25 1/2"	18"	39"	21"	25"	26 1/2"
OMC309324AH	24"	24"	28 1/2"	18"	39"	24"	25"	26 1/2"
OMC339324AH	24"	27"	31 1/2"	18"	39"	27"	25"	26 1/2"
OMC279624	27"	21"	25 1/2"	18"	39"	21"	28"	29 1/2"
OMC309624	27"	24"	28 1/2"	18"	39"	24"	28"	29 1/2"
OMC339624	27"	27"	31 1/2"	18"	39"	27"	28"	29 1/2"

	A Frame Opening Height	B Cut-out Width (standard)		B Cut-out Width (with ACS modification)			C Cut-out Height		Door Height (Upper Section)	
		Min.	Max.	Min.	Max.	Max. w/ Field Cut	Min.	Max.	Partial Overlay	Full Overlay
OMC279324N	24"	24"	25 1/2"	21"	24"	25 1/2"	18"	33"	25"	26 1/2"
OMC309324N	24"	27"	28 1/2"	24"	27"	28 1/2"	18"	33"	25"	26 1/2"
OMC339324N	24"	30"	31 1/2"	27"	30"	31 1/2"	18"	33"	25"	26 1/2"
OMC279624N	27"	24"	25 1/2"	21"	24"	25 1/2"	18"	33"	28"	29 1/2"
OMC309624N	27"	27"	28 1/2"	24"	27"	28 1/2"	18"	33"	28"	29 1/2"
OMC339624N	27"	30"	31 1/2"	27"	30"	31 1/2"	18"	33"	28"	29 1/2"

**Custom Modifications**

ACS	ADDTK	AUTHL AUTHR	CBO	CCO	CFNTO	CFRMO	CND	DRT	DRWTK	EXBKL EXBKR	EXL EXR
•*		•	•	•		•	•			•	•
FB	FFDL FFDR	FPEB	FTK	FTKAV FTKRV	ID	INVRM	MIP	RD	RECTKL RECTKR	RT	TD
TKP	VTK	WLI									

\*Only available on Narrow Stile (N) cabinets

**Construction Upgrades**

APC	ET	PE
•		•

**Door Options**

CG.TOP	DPSRR	MFO
	•	•

**OVEN MICROWAVE CABINET, DEEP DRAWER, 84", 87", or 90" TALL, 24" DEEP**

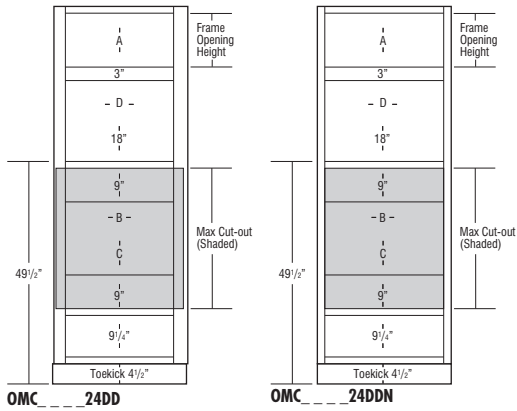
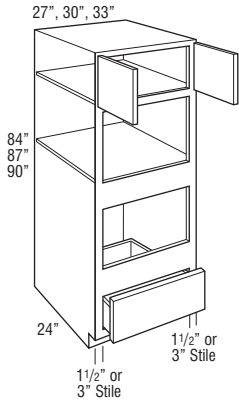

Model	Cubic Feet
OMC278424DD(N)	37.4
OMC308424DD(N)	41.3
OMC338424DD(N)	45.2
OMC278724DD(N)	38.7
OMC308724DD(N)	42.8
OMC338724DD(N)	46.8
OMC279024DD(N)	40.0
OMC309024DD(N)	44.2
OMC339024DD(N)	48.4

- N represents Narrow Stile cabinets with 1 1/2" wide face frame side stiles and ACS modification availability (see page 46 for ACS specifications). Doors and drawer fronts have a consistent width reveal for full overlay (1/4") and partial overlay (1") and use standard Smart Stop hinges.
- On cabinets with 3" wide face frame side stiles, full overlay styles have a consistent 1/4" width frame reveal and use face mounted Smart Stop hinges. Partial overlay styles have a larger 2 1/2" width reveal, use standard Smart Stop hinges, and are not recommended for stacking applications due to misalignment of door width with cabinets above.
- Designed for use with separate built-in microwave above, built-in oven below. For built-in double ovens, see pages 287-292.
- All top and bottom cross rails are 1 1/2" wide.
- All toe-kick areas are 4 1/2" high.
- Be sure to confirm a heat shield is built into your appliance by the manufacturer or install the heat shield included with your appliance. Heat shields are sold separately as an accessory.
- Depth can be reduced to a minimum of 12".
- For built-in appliance support, OCINSTALLKIT is included in 24" deep oven cabinets (see page 422 for details). Oven install kit will not be included when depth is modified.
- Maximum cut-out dimension will allow 1/4" reveal for doors and drawer fronts on full overlay and 1" for partial overlay for trim kit face clearance.

	A Frame Opening Height	B Cut-out Width		C Cut-out Height		D Frame Opening Width	Door Height (Upper Section)	
		Min.	Max.	Min.	Max.		Partial Overlay	Full Overlay
OMC278424DD	12"	21"	25 1/2"	16 1/4"	31 1/4"	21"	13"	14 1/2"
OMC308424DD	12"	24"	28 1/2"	16 1/4"	31 1/4"	24"	13"	14 1/2"
OMC338424DD	12"	27"	31 1/2"	16 1/4"	31 1/4"	27"	13"	14 1/2"
OMC278724DD	15"	21"	25 1/2"	16 1/4"	31 1/4"	21"	16"	17 1/2"
OMC308724DD	15"	24"	28 1/2"	16 1/4"	31 1/4"	24"	16"	17 1/2"
OMC338724DD	15"	27"	31 1/2"	16 1/4"	31 1/4"	27"	16"	17 1/2"
OMC279024DD	18"	21"	25 1/2"	16 1/4"	31 1/4"	21"	19"	20 1/2"
OMC309024DD	18"	24"	28 1/2"	16 1/4"	31 1/4"	24"	19"	20 1/2"
OMC339024DD	18"	27"	31 1/2"	16 1/4"	31 1/4"	27"	19"	20 1/2"

	A Frame Opening Height	B Cut-out Width (standard)		B Cut-out Width (with ACS modification)			C Cut-out Height		Door Height (Upper Section)	
		Min.	Max.	Min.	Max.	Max. w/ Field Cut	Min.	Max.	Partial Overlay	Full Overlay
OMC278424DDN	12"	24"	25 1/2"	21"	24"	25 1/2"	16 1/4"	31 1/4"	13"	14 1/2"
OMC308424DDN	12"	27"	28 1/2"	24"	27"	28 1/2"	16 1/4"	31 1/4"	13"	14 1/2"
OMC338424DDN	12"	30"	31 1/2"	27"	30"	31 1/2"	16 1/4"	31 1/4"	13"	14 1/2"
OMC278724DDN	15"	24"	25 1/2"	21"	24"	25 1/2"	16 1/4"	31 1/4"	16"	17 1/2"
OMC308724DDN	15"	27"	28 1/2"	24"	27"	28 1/2"	16 1/4"	31 1/4"	16"	17 1/2"
OMC338724DDN	15"	30"	31 1/2"	27"	30"	31 1/2"	16 1/4"	31 1/4"	16"	17 1/2"
OMC279024DDN	18"	24"	25 1/2"	21"	24"	25 1/2"	16 1/4"	31 1/4"	19"	20 1/2"
OMC309024DDN	18"	27"	28 1/2"	24"	27"	28 1/2"	16 1/4"	31 1/4"	19"	20 1/2"
OMC339024DDN	18"	30"	31 1/2"	27"	30"	31 1/2"	16 1/4"	31 1/4"	19"	20 1/2"

**Custom Modifications**

ACS	ADDTK	AUTHL AUTHR	CBO	CCO	CFNTD	CFRMO	CND	DRT	DRWTK	EXBKL EXBKR	EXL EXR
•*		•	•	•		•	•			•	•
FB	FFDL FFDR	FPEB	FTK	FTKAV FTKRV	ID	INVFRM	MIP	RD	RECTKL RECTKR	RT	TD
•		•	•	•			•	•	•		•*
TKP	VTK	WLI									
•	•	•									

\*Only available on Narrow Stile (N) cabinets \*Not available on 84" tall

**Construction Upgrades**

APC	ET	PE
•		•

**Door Options**

CG.TOP	DPSRR	MFO
	•	•

# OVEN MICROWAVE CABINET, DEEP DRAWER, 93" or 96" TALL, 24" DEEP

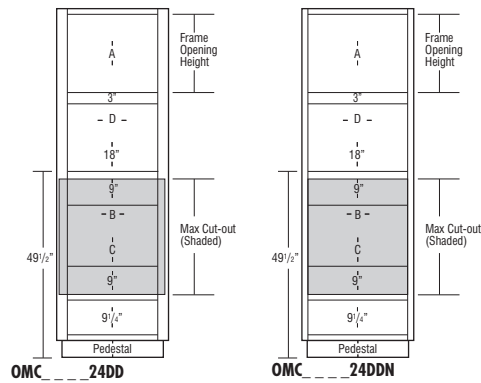
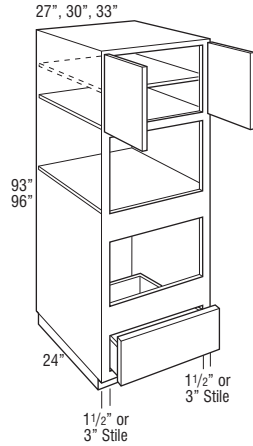

Model	Cubic Feet
OMC279324DD (AH or N)	41.3
OMC309324DD (AH or N)	45.7
OMC339324DD (AH or N)	50.0
OMC279624DD (AH or N)	42.6
OMC309624DD (AH or N)	47.1
OMC339624DD (AH or N)	51.6

- AH represents upper section alignment with doors on 24" or 27" high cabinets.
- N represents Narrow Stile cabinets with 1 1/2" wide face frame side stiles and ACS modification availability (see page 46 for ACS specifications). Doors and drawer fronts have a consistent width reveal for full overlay (1/4") and partial overlay (1") and use standard Smart Stop hinges.
- On cabinets with 3" wide face frame side stiles, full overlay styles have a consistent 1/4" width frame reveal and use face mounted Smart Stop hinges. Partial overlay styles have a larger 2 1/2" width reveal, use standard Smart Stop hinges, and are not recommended for stacking applications due to misalignment of door width with cabinets above.
- Designed for use with separate built-in microwave above, built-in oven below. For built-in double ovens, see pages 287-292.
- All top and bottom cross rails are 1 1/2" wide.
- All toekick areas are 4 1/2" high.
- Be sure to confirm a heat shield is built into your appliance by the manufacturer or install the heat shield included with your appliance. Heat shields are sold separately as an accessory.
- Separate pedestal base included but packaged separately on 93" and 96" tall. Pedestal is designed to create a Recessed Left or Right ToeKick application during field installation, or can be centered. Pedestal must be covered with toeboard material.
- One full depth adjustable shelf included, but packaged separately.
- Depth can be reduced to a minimum of 12".
- For built-in appliance support, OCINSTALLKIT is included in 24" deep oven cabinets (see page 422 for details). Oven install kit will not be included when depth is modified.
- Maximum cut-out dimension will allow 1/4" reveal for doors and drawer fronts on full overlay and 1" for partial overlay for trim kit face clearance.

	A Frame Opening Height	B Cut-out Width		C Cut-out Height		D Frame Opening Width	Door Height (Upper Section)	
		Min.	Max.	Min.	Max.		Partial Overlay	Full Overlay
OMC279324DDAH	21"	21"	25 1/2"	16 1/4"	31 1/4"	21"	22"	23 1/2"
OMC309324DDAH	21"	24"	28 1/2"	16 1/4"	31 1/4"	24"	22"	23 1/2"
OMC339324DDAH	21"	27"	31 1/2"	16 1/4"	31 1/4"	27"	22"	23 1/2"
OMC279624DDAH	24"	21"	25 1/2"	16 1/4"	31 1/4"	21"	25"	26 1/2"
OMC309624DDAH	24"	24"	28 1/2"	16 1/4"	31 1/4"	24"	25"	26 1/2"
OMC339624DDAH	24"	27"	31 1/2"	16 1/4"	31 1/4"	27"	25"	26 1/2"

	A Frame Opening Height	B Cut-out Width (standard)		B Cut-out Width (with ACS modification)			C Cut-out Height		Door Height (Upper Section)	
		Min.	Max.	Min.	Max.	Max. w/ Field Cut	Min.	Max.	Partial Overlay	Full Overlay
OMC279324DDN	21"	24"	25 1/2"	21"	24"	25 1/2"	16 1/4"	31 1/4"	22"	23 1/2"
OMC309324DDN	21"	27"	28 1/2"	24"	27"	28 1/2"	16 1/4"	31 1/4"	22"	23 1/2"
OMC339324DDN	21"	30"	31 1/2"	27"	30"	31 1/2"	16 1/4"	31 1/4"	22"	23 1/2"
OMC279624DDN	24"	24"	25 1/2"	21"	24"	25 1/2"	16 1/4"	31 1/4"	25"	26 1/2"
OMC309624DDN	24"	27"	28 1/2"	24"	27"	28 1/2"	16 1/4"	31 1/4"	25"	26 1/2"
OMC339624DDN	24"	30"	31 1/2"	27"	30"	31 1/2"	16 1/4"	31 1/4"	25"	26 1/2"

### Custom Modifications

ACS	ADDTK	AUTHL AUTHR	CBO	CCO	CFNTO	CFRMO	CND	DRT	DRWTK	EXBKL EXBKR	EXL EXR
•*		•	•	•		•	•			•	•
FB	FFDL FFDR	FPEB	FTK	FTKAV FTKRV	ID	INVFRM	MIP	RD	RECTKL RECTKR	RT	TD
•		•			•		•	•	•		•
TKP	VTK	WLI									
		•									

\*Only available on Narrow Stile (N) cabinets

### Construction Upgrades

APC	ET	PE
•		•

### Door Options

CG.TOP	DPSRR	MFO
	•	•

**OVEN MICROWAVE CABINET,  
WARMING DRAWER, 84", 87", 90",  
93", or 96" TALL, 24" DEEP**

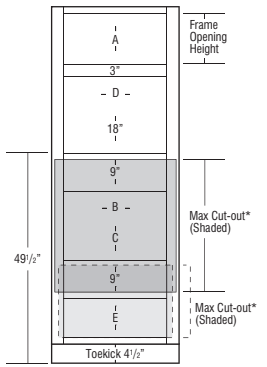
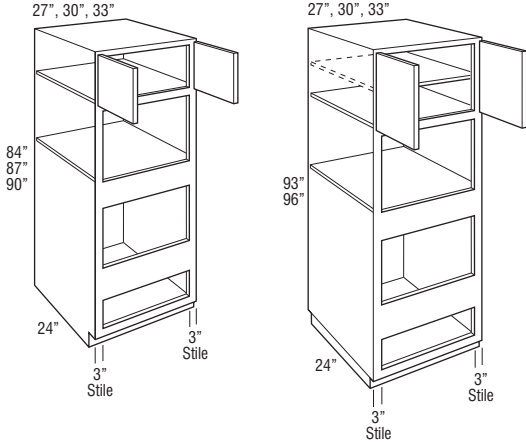

\*Minimum rail height between oven and warming drawer is 1 1/2"

Model	Cubic Feet	Model	Cubic Feet
OMC278424WD	37.4	OMC279324WDAH	41.3
OMC308424WD	41.3	OMC309324WDAH	45.7
OMC338424WD	45.2	OMC339324WDAH	50.0
OMC278724WD	38.7	OMC279624WDAH	42.6
OMC308724WD	42.8	OMC309624WDAH	47.1
OMC338724WD	46.8	OMC339624WDAH	51.6
OMC279024WD	40.0		
OMC309024WD	44.2		
OMC339024WD	48.4		

- AH represents upper section alignment with doors on 24" or 27" high cabinets.
- Includes one adjustable shelf in upper section of 93" and 96" tall.
- Designed for use with separate built-in microwave above, built-in oven below. For built-in double ovens, see pages 287-292.
- Full overlay styles feature concealed face mount Smart Stop hinges.
- All top and bottom cross rails are 1 1/2" wide.
- All toe kick areas are 4 1/2" high.
- Be sure to confirm a heat shield is built into your appliance by the manufacturer or install the heat shield included with your appliance. Heat shields are sold separately as an accessory.
- Separate pedestal base included but packaged separately on 93" and 96" tall. Pedestal is designed to create a Recessed Left or Right Toe Kick application during field installation, or can be centered. Pedestal must be covered with toeboard material.
- Depth can be reduced to a minimum of 6". For depths of 6"-8", cabinet will not include toe kick/pedestal.
- For built-in appliance support, OCINSTALLKIT is included in 24" deep oven cabinets (see page 422 for details). Oven install kit will not be included when depth is modified.

	A Frame Opening Height	B Cut-out Width		C Cut-out Height		D Frame Opening Width	E Warming Drawer Cut-out Height		Door Height (Upper Section)	
		Min.	Max.	Min.	Max.		Min.	Max.	Partial Overlay	Full Overlay
OMC278424WD	12"	21"	25 1/2"	16 1/4"	31 1/4"	21"	9 1/4"	16 3/4"	13"	14 1/2"
OMC308424WD	12"	24"	28 1/2"	16 1/4"	31 1/4"	24"	9 1/4"	16 3/4"	13"	14 1/2"
OMC338424WD	12"	27"	31 1/2"	16 1/4"	31 1/4"	27"	9 1/4"	16 3/4"	13"	14 1/2"
OMC278724WD	15"	21"	25 1/2"	16 1/4"	31 1/4"	21"	9 1/4"	16 3/4"	16"	17 1/2"
OMC308724WD	15"	24"	28 1/2"	16 1/4"	31 1/4"	24"	9 1/4"	16 3/4"	16"	17 1/2"
OMC338724WD	15"	27"	31 1/2"	16 1/4"	31 1/4"	27"	9 1/4"	16 3/4"	16"	17 1/2"
OMC279024WD	18"	21"	25 1/2"	16 1/4"	31 1/4"	21"	9 1/4"	16 3/4"	19"	20 1/2"
OMC309024WD	18"	24"	28 1/2"	16 1/4"	31 1/4"	24"	9 1/4"	16 3/4"	19"	20 1/2"
OMC339024WD	18"	27"	31 1/2"	16 1/4"	31 1/4"	27"	9 1/4"	16 3/4"	19"	20 1/2"
OMC279324WDAH	21"	21"	25 1/2"	16 1/4"	31 1/4"	21"	9 1/4"	16 3/4"	22"	23 1/2"
OMC309324WDAH	21"	24"	28 1/2"	16 1/4"	31 1/4"	24"	9 1/4"	16 3/4"	22"	23 1/2"
OMC339324WDAH	21"	27"	31 1/2"	16 1/4"	31 1/4"	27"	9 1/4"	16 3/4"	22"	23 1/2"
OMC279624WDAH	24"	21"	25 1/2"	16 1/4"	31 1/4"	21"	9 1/4"	16 3/4"	25"	26 1/2"
OMC309624WDAH	24"	24"	28 1/2"	16 1/4"	31 1/4"	24"	9 1/4"	16 3/4"	25"	26 1/2"
OMC339624WDAH	24"	27"	31 1/2"	16 1/4"	31 1/4"	27"	9 1/4"	16 3/4"	25"	26 1/2"

Maximum cut-out dimension will allow 1/4" reveal for doors and drawer fronts on full overlay and 1" for partial overlay for trim kit face clearance.

**Custom Modifications**

ACS	ADDTK	AUTHL AUTHR	CBO	CCO	CFNTO	CFRMO	CND	DRT	DRWTK	EXBKL EXBKR	EXL EXR
		•	•*		•	•			•+	•	•
	FFDL FFDR	FPEB	FTK	FTKAV FTKRV	ID	INVFRM	MIP	RD	RECTKL RECTKR	RT	TD
•		•	•+	•+	•		•	•	•		•▲
TKP	VTK	WLI									
•+	•+	•									

\*Not available on 84", 87", and 90" tall    +Not available on 93" and 96" tall    ▲Not available on 84" tall

**Construction Upgrades**

APC	ET	PE
•		•

**Door Options**

CG.TOP	DPSRR	MFO
	•	•

# Diamond®

## DISTINCTION™ SERIES

### OFFICE & FURNITURE CABINET NOMENCLATURE

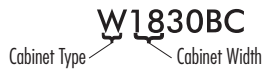

#### NOTE:

If order is placed in Arch door style, Office and Furniture bases will have Square doors.

All bookcase shelves are 3/4" thick plywood with 1 1/2" tall solid-wood rail attached.

All office base cabinets are predrilled for full depth shelves or roll trays.

### MODIFICATIONS GRID KEY

- Available Standard on these cabinets
- 5 Day Express Response Item

CUSTOM MODIFICATIONS				CONSTRUCTION UPGRADES				DOOR OPTIONS	
Mod.	Description	Mod.	Description	Mod.	Description	Mod.	Description	Mod.	Description
ADDTK	Add Toekick	EXL	Extended Sstile - Left	PTOWB	Push to Open Wastebasket	APC	All-plywood Construction	DPSRR	Door Panel - Solid Reverse Raised
AUTHL	Authentic End - Left	EXR	Extended Sstile - Right	RD	Reduced Depth	PE	Plywood Ends		
AUTHR	Authentic End - Right	FB	Finished Ends	RECTKALL	Recessed Island Toekick				
CBO	Cabinet Box Only	FFDL	Face Frame and Door on End - Left	RECTKBK	Recessed Toekick - Back				
CCO	Cabinet Case Only	FFDR	Face Frame and Door on End - Right	RECTKL	Recessed Toekick - Left				
CFNTO	Cabinet Front Only	FPEB	Furniture Finished Plywood Ends	RECTKR	Recessed Toekick - Right				
CFP	Cabinet False Panel	FTK	Flush Toekick	RT	Installed Roll Tray				
CFRMO	Cabinet Frame Only	FTKAV	Flush Toekick Arch	TVRAV	Valance Top Rail, Arch				
CND	Cabinet with No Door, with Drawer	FTKAV	Flush Toekick Furniture	TVRFV	Valance Top Rail, Furniture				
DRWSEC	Biometric Secured Drawer	ID	Increased Depth	TVRVV	Valance Top Rail, Straight				
DRWTK	Toekick Drawer	INVRM	Inverted Frame	VTK	Void Toekick				
EXBKL	End Extended Back - Left	LTI	Light Installed Battery Strip	WLI	White Laminate Interior				
EXBKR	End Extended Back - Right	MIP	Matching Interior Plywood						
		PFINBTMB	Prepare Cabinet for Finished Bottom						

### BOOKCASE, 30" HIGH, 12" DEEP

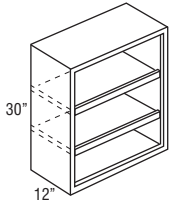

Model	Cubic Feet
<b>W1830BC</b>	5.3
<b>W2430BC</b>	6.9
<b>W3030BC</b>	8.5
<b>W3630BC</b>	10.0

- Matching Interior Plywood (MIP) standard.
- Face frame has a profiled inside edge.
- If ordered with Heirloom Technique, will not feature sand-through characteristics.
- To change the top rail valance, specify one of the following modifications: Arch (TVRAV), Furniture (TVRFV), or Straight Valance (TVRVV).

#### Custom Modifications

	AUTHL AUTHR	CBO	CCO	CFNTO	CFP	CFRMO	CND	DRWSEC	DRWTK	EXBKL EXBKR	EXL EXR
	•	•	STD			•				•	•
FB	FFDL FFDR	FPEB	FTK	FTKAV FTKFV	ID	INVRM	LTI	MIP	PFINBTMB	PTOWB	RD
		•			•			STD	•		•
RECTKALL RECTKBK	RECTKL RECTKR			TVRAV TVRFV TVRVV	VTK	WLI					
				•							

#### Construction Upgrades

APC	PE

#### Door Options

DPSRR

**BOOKCASE, 48" HIGH, 12" DEEP**

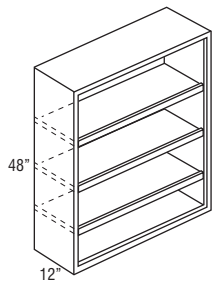

Model	Cubic Feet
<b>W1848BC</b>	8.2
<b>W2448BC</b>	10.7
<b>W3048BC</b>	13.2
<b>W3648BC</b>	15.7

- Matching Interior Plywood (MIP) standard.
- Face frame has a profiled inside edge.
- If ordered with Heirloom Technique, will not feature sand-through characteristics.
- To change the top rail valance, specify one of the following modifications: Arch (TVRAV), Furniture (TVRFV), or Straight Valance (TVRVV).

**Custom Modifications**

ADDTK	AUTHL AUTHR	CBO	CCO	CFNTO	CFP	CFRMO	CND	DRWSEC	DRWTK	EXBKL EXBKR	EXL EXR
•	•	STD				•				•	•
FB	FFDL FFDR	FPEB	FTK	FTKAV FTKRV	ID	INVFRM	LTI	MIP	PFINBTMB	PTOWB	RD
		•			•			STD	•		•
RECTKALL RECTKBK	RECTKL RECTKR	RT	TVRAV TVRFV TVRVV	VTK	WLI						
			•								

**Construction Upgrades**

APC	PE

**Door Options**

DPSRR

**WALL FURNITURE BOOKCASE, 48", 51", or 54" HIGH, 12" DEEP**

18", 24", 30", or 36"

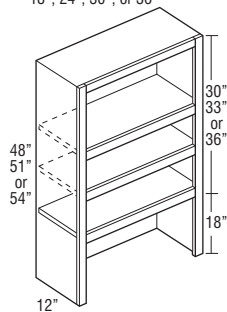

<b>WFBC1848</b>	8.1
<b>WFBC2448</b>	10.5
<b>WFBC3048</b>	13.0
<b>WFBC3648</b>	15.4
<b>WFBC1851</b>	8.6
<b>WFBC2451</b>	11.2
<b>WFBC3051</b>	13.7
<b>WFBC3651</b>	16.3
<b>WFBC1854</b>	9.1
<b>WFBC2454</b>	11.8
<b>WFBC3054</b>	14.5
<b>WFBC3654</b>	17.2

- 48", 51", and 54" have two adjustable shelves and one fixed shelf.
- Matching Interior Plywood (MIP) standard.
- Face frame has a profiled inside edge.
- If ordered with Heirloom Technique, will not feature sand-through characteristics.
- To change the top rail valance, specify one of the following modifications: Arch (TVRAV), Furniture (TVRFV), or Straight Valance (TVRVV).
- Bookcases can only be reduced to 9".

**Custom Modifications**

ADDTK	AUTHL AUTHR	CBO	CCO	CFNTO	CFP	CFRMO	CND	DRWSEC	DRWTK	EXBKL EXBKR	EXL EXR
	•	STD				•				•	•
FB	FFDL FFDR	FPEB	FTK	FTKAV FTKRV	ID	INVFRM	LTI	MIP	PFINBTMB	PTOWB	RD
		•			•			STD			•
RECTKALL RECTKBK	RECTKL RECTKR	RT	TVRAV TVRFV TVRVV	VTK	WLI						
			•								

**Construction Upgrades**

APC	PE

**Door Options**

DPSRR

**WALL FURNITURE BOOKCASE, 57", 60", or 66" HIGH, 12" DEEP**

18", 24", 30", or 36"

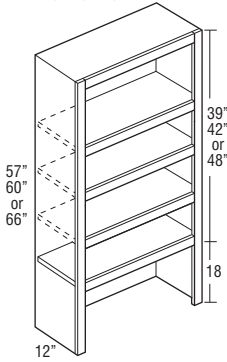

Model	Cubic Feet
WFBC1857	9.6
WFBC2457	12.4
WFBC3057	15.3
WFBC3657	18.2
WFBC1860	9.6
WFBC2460	13.1
WFBC3060	16.1
WFBC3660	19.1
WFBC1866	11.0
WFBC2466	14.3
WFBC3066	17.6
WFBC3666	20.9

- 57", 60", and 66" have three adjustable shelves and one fixed shelf.
- Matching Interior Plywood (MIP) standard.
- Face frame has a profiled inside edge.
- If ordered with Heirlooming Technique, will not feature sand-through characteristics.
- To change the top rail valance, specify one of the following modifications: Arch (TVRAV), Furniture (TVRFV), or Straight Valance (TVRVV).
- Bookcases can only be reduced to 9".

**Custom Modifications**

ADDTK	AUTHL AUTHR	CBO	CCO	CFNT0	CFP	CFRMO	CND	DRWSEC	DRWTK	EXBKL EXBKR	EXL EXR
	•*	STD				•				•	•
FB	FFDL FFDR	FPEB	FTK	FTKAV FTKRV	ID	INVFRM	LTI	MIP	PFINBTMB	PTOWB	RD
		•			•			STD			•
RECTKALL RECTKBK	RECTKL RECTKR	RT	TVRAV TVRFV TVRVV	VTK	WLI						
			•								

\*Not available on 66" high

**Construction Upgrades**

APC	PE

**Door Options**

DPSRR

**TALL BOOKCASE, 84", 87", or 90" HIGH, 12" or 18" DEEP**

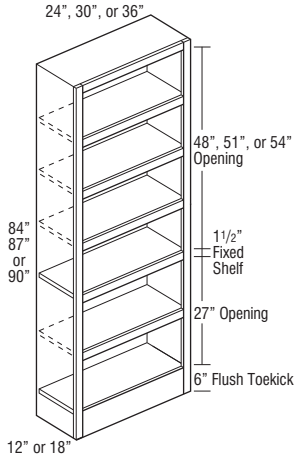

Model	Cubic Feet	Model	Cubic Feet
TBC248412	18.1	TBC248718	26.8
TBC308412	22.3	TBC308718	33.0
TBC368412	26.5	TBC368718	39.1
TBC248418	25.9	TBC249012	19.4
TBC308418	31.9	TBC309012	23.9
TBC368418	37.8	TBC369012	28.3
TBC248712	18.7	TBC249018	27.7
TBC308712	23.1	TBC309018	34.1
TBC368712	27.4	TBC369018	40.5

- 84" and 87" tall include four adjustable shelves and one fixed shelf.
- 90" tall includes five adjustable shelves and one fixed shelf.
- Matching Interior Plywood (MIP) standard.
- Face frame has a profiled inside edge.
- If ordered with Heirloom Technique, will not feature sand-through characteristics.
- To change the top rail valance, specify one of the following modifications: Arch (TVRAV), Furniture (TVRFV), or Straight Valance (TVRVV).
- Bookcases can only be reduced to 9".

**Custom Modifications**

ADDTK	AUTHL AUTHR	CBO	CCO	CFNTO	CFP	CFRMO	CND	DRWSEC	DRWTK	EXBKL EXBKR	EXL EXR
		STD				•				•	•
FB	FFDL FFDR	FPEB	FTK	FTKAV FTKRV	ID	INVFRM	LTI	MIP	PFINBTMB	PTOWB	RD
		•	STD	•	•			STD			•
RECTKALL RECTKBK	RECTKL RECTKR	RT	TVRAV TVRFV TVRVV	VTK	WLI						
			•								

**Construction Upgrades**

APC	PE

**Door Options**

DPSRR



**TALL BOOKCASE, 93" or 96" HIGH,  
12" or 18" DEEP**

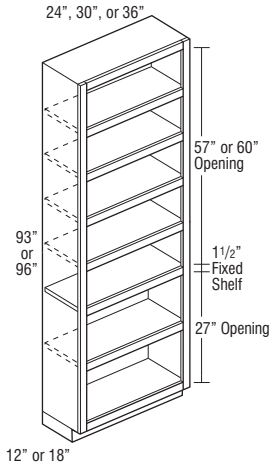

Model	Cubic Feet
TBC249312	20.0
TBC309312	24.6
TBC369312	29.2
TBC249318	28.6
TBC309318	35.2
TBC369318	41.8
TBC249612	20.6
TBC309612	25.4
TBC369612	30.2
TBC249618	29.5
TBC309618	36.3
TBC369618	43.1

- 93" tall includes five adjustable shelves and one fixed shelf.
- 96" tall includes six adjustable shelves and one fixed shelf.
- Separate pedestal base included but packaged separately on 93" and 96" tall. Pedestals are the same width as the cabinet box except when specified with FPFB, in which the pedestal will be 1/4" recessed when centered.
- Matching Interior Plywood (MIP) standard.
- Face frame has a profiled inside edge.
- If ordered with Heirloom Technique, will not feature sand-through characteristics.
- To change the top rail valance, specify one of the following modifications: Arch (TVRAV), Furniture (TVRFV), or Straight Valance (TVRVV).
- Bookcases can only be reduced to 9".

**Custom Modifications**

ADDTK	AUTHL AUTHR	CBO	CCO	CFNTD	CFP	CFRMO	CND	DRWSEC	DRWTK	EXBKL EXBKR	EXL EXR
		STD				•				•	•
FB	FFDL FFDR	FPEB	FTK	FTKAV FTKRV	ID	INVFRM	LTI	MIP	PFINBTMB	PTOWB	RD
		•			•			STD			•
RECTKALL RECTKBL	RECTKL RECTKR	RT	TVRAV TVRFV TVRVV	VTK	WLI						
			•								

**Construction Upgrades**

APC	PE

**Door Options**

DPSRR

**TALL BOOKCASE with DOORS, 84", 87", or 90" HIGH, 12" or 18" DEEP**

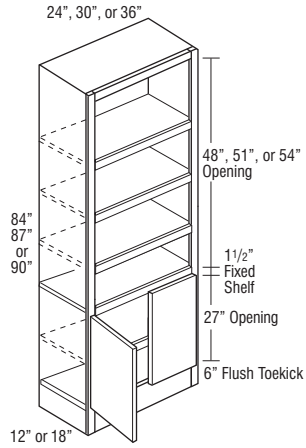

Model	Cubic Feet	Model	Cubic Feet
TBCD248412	18.1	TBCD248718	26.8
TBCD308412	22.3	TBCD308718	33.0
TBCD368412	26.5	TBCD368718	39.1
TBCD248418	25.9	TBCD249012	19.4
TBCD308418	31.9	TBCD309012	23.9
TBCD368418	37.8	TBCD369012	28.3
TBCD248712	18.7	TBCD249018	27.7
TBCD308712	23.1	TBCD309018	34.1
TBCD368712	27.4	TBCD369018	40.5

- 84" and 87" tall include four adjustable shelves and one fixed shelf.
- 90" tall includes five adjustable shelves and one fixed shelf.
- Matching Interior Plywood (MIP) standard.
- Face frame has a profiled inside edge.
- Top of doors match to a standard, full height base door, 34 1/2" high.
- To change the top rail valance, specify one of the following modifications: Arch (TVRAV), Furniture (TVRFV), or Straight Valance (TVRVV).
- Bookcases can only be reduced to 9".

**Custom Modifications**

ADDTK	AUTHL AUTHR	CBO	CCO	CFNTO	CFP	CFRMO	CND	DRWSEC	DRWTK	EXBKL EXBKR	EXL EXR
		•	•	•		•				•	•
FB	FFDL FFDR	FPEB	FTK	FTKAV FTKRV	ID	INVFRM	LTI	MIP	PFINBTMB	PTOWB	RD
		•	STD	•	•			STD			•
RECTKALL RECTKBK	RECTKL RECTKR	RT	TVRAV TVRFV TVRVV	VTK	WLI						
			•								

**Construction Upgrades**

APC	PE

**Door Options**

DPSRR
•

**TALL BOOKCASE with DOORS, 93" or 96" HIGH, 12" or 18" DEEP**

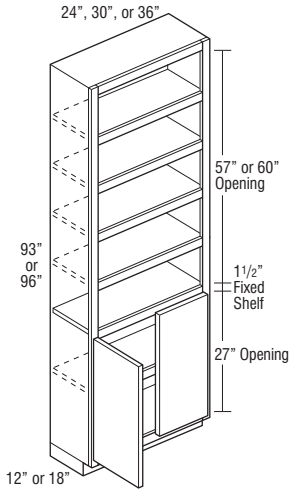

Model	Cubic Feet	Model	Cubic Feet
TBCD249312	20.0	TBCD249612	20.6
TBCD309312	24.6	TBCD309612	25.4
TBCD369312	29.2	TBCD369612	30.2
TBCD249318	28.6	TBCD249618	29.5
TBCD309318	35.2	TBCD309618	36.3
TBCD369318	41.8	TBCD369618	43.1

- 93" tall includes five adjustable shelves and one fixed shelf.
- 96" tall includes six adjustable shelves and one fixed shelf.
- Separate pedestal base included but packaged separately on 93" and 96" tall. Pedestals are the same width as the cabinet box except when specified with FPED, in which the pedestal will be 1/4" recessed when centered.
- Matching Interior Plywood (MIP) standard.
- Face frame has a profiled inside edge.
- Top of doors match to a standard, full height base door, 34 1/2" high.
- To change the top rail valance, specify one of the following modifications: Arch (TVRAV), Furniture (TVRFV), or Straight Valance (TVRVV).
- Bookcases can only be reduced to 9".

**Custom Modifications**

ADDTK	AUHL AUTHR	CBO	CCO	CFNT0	CFP	CFRMO	CND	DRWSEC	DRWTK	EXBKL EXBKR	EXL EXR
		•	•	•		•				•	•
FB	FFDL FFDR	FPEB	FTK	FTKAV FTKRV	ID	INVFRM	LTI	MIP	PFINBTMB	PTOWB	RD
		•			•			STD			•
RECTKALL RECTKBK	RECTKL RECTKR	RT	TVRAV TVRFV TVRVV	VTK	WLI						
			•								

**Construction Upgrades**

APC	PE

**Door Options**

DPSRR
•

**DESK DOOR DRAWER BASE,  
29" HIGH, 21" or 24" DEEP**

12", 15", 18", or 21"

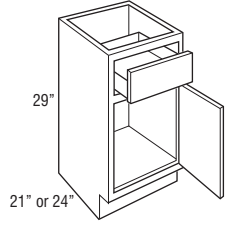

DDO122924 L or R  
DDO152924 L or R  
DDO182924 L or R  
DDO212924 L or R

24", 27", 30", 33", or 36"

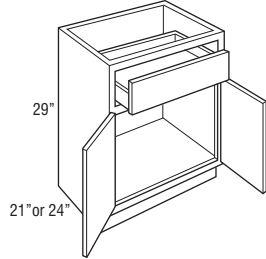

DDO242921 DDO242924  
DDO272921 DDO272924  
DDO302921 DDO302924  
DDO332921 DDO332924  
DDO362921 DDO362924

Model	Cubic Feet	Model	Cubic Feet
DDO122921 L or R	6.4	DDO242921	11.9
DDO152921 L or R	7.8	DDO272921	13.0
DDO182921 L or R	9.1	DDO302921	14.9
DDO212921 L or R	10.5	DDO332921	13.0
DDO122924 L or R	7.3	DDO362921	17.9
DDO152924 L or R	8.8	DDO242924	13.4
DDO182924 L or R	10.2	DDO272924	13.3
DDO212924 L or R	11.8	DDO302924	14.6
		DDO332924	16.1
		DDO362924	17.3

- Depth can be reduced to a minimum of 12".
- Depth can be increased to a maximum of 24".

**Custom Modifications**

	ADDTK	AUTHL AUTHR	CBO	CCO	CFNT0	CFP	CFRMO	CND	DRWSEC	DRWTK	EXBKL EXBKR	EXL EXR
	•*	•	•	•	•	•	•	•	•†	•▲	•	•
FB	FFDL FFDR	FPEB	FTK	FTKAV FTKRV	ID	INVRM	LTI	MIP	PFINBTMB	PTOWB	RD	
•	•	•	•	•†	•†	•	•†	•				•
RECTKALL RECTKBK	RECTKL RECTKR	RT	TVRAV TVRFV TVRVV	VTK	WLI							
•	•	•	•	•	•							

\*Not available on 21" deep    †Available only on 18", 21", and 24" wide    ▲Not available on 12" and 15" wide  
 ‡Not available on 12" wide    †Not available on 24" deep

**Construction Upgrades**

APC	PE
•	•

**Door Options**

DPSRR
•

**DESK DRAWER BASE, 29" HIGH,  
21" or 24" DEEP**

12", 15", 18", 21",  
24", 27", 30", 33", or 36"

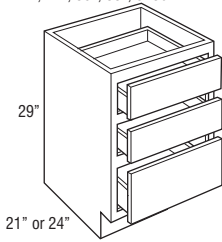

Model	Cubic Feet	Model	Cubic Feet
DDR122921	6.4	DDR242921	11.9
DDR152921	7.8	DDR272921	12.0
DDR182921	9.1	DDR302921	13.2
DDR212921	10.5	DDR332921	14.4
DDR122924	7.3	DDR362921	15.7
DDR152924	8.8	DDR242924	13.4
DDR182924	10.2	DDR272924	13.5
DDR212924	11.8	DDR302924	14.9
		DDR332924	16.3
		DDR362924	17.7

- Depth can be reduced to a minimum of 12".
- Depth can be increased to a maximum of 24".

**Custom Modifications**

ADDTK	AUTHL AUTHR	CBO	CCO	CFNTD	CFP	CFRMO	CND	DRWSEC	DRWTK	EXBKL EXBKR	EXL EXR
	•*	•	•		•	•		•+	•▲	•	•
FB	FFDL FFDR	FPEB	FTK	FTKAV FTKFV	ID	INVRM	LTI	MIP	PFINBTMB	PTOWB	RD
•		•	•	•†				•			•
RECTKALL RECTKBK	RECTKL RECTKR	RT	TVRAV TVRFV TVRVV	VTK	WLI						
•	•			•							

\*Not available on 21" deep \*Available only on 18" and 21" wide, 24" deep, and 24" wide, 21" deep  
 †Not available on 12" and 15" wide †Not available on 12" wide

**Construction Upgrades**

APC	PE
•	•

**Door Options**

DPSRR

**DESK FILE DRAWER BASE, 29" HIGH,  
21" or 24" DEEP**

15", 18", or 21"

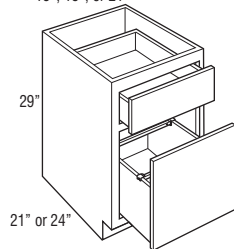

DFD152921	7.8
DFD182921	9.1
DFD212921	10.5
DFD152924	8.8
DFD182924	10.2
DFD212924	11.8

- Door is attached to file drawer.
- Includes Filing System Hardware Kit, which accommodates letter and legal filing.
- Exterior height of file drawer is 10".

**Custom Modifications**

ADDTK	AUTHL AUTHR	CBO	CCO	CFNTD	CFP	CFRMO	CND	DRWSEC	DRWTK	EXBKL EXBKR	EXL EXR
	•*	•	•			•		•+	•▲	•	•
FB	FFDL FFDR	FPEB	FTK	FTKAV FTKFV	ID	INVRM	LTI	MIP	PFINBTMB	PTOWB	RD
•		•	•	•				•			
RECTKALL RECTKBK	RECTKL RECTKR	RT	TVRAV TVRFV TVRVV	VTK	WLI						
•	•			•							

\*Not available on 21" deep \*Available only on 18" and 21" wide, 24" deep \*Not available on 15" wide

**Construction Upgrades**

APC	PE
•	•

**Door Options**

DPSRR

**DESK DOUBLE FILE DRAWER BASE,  
29" HIGH, 21" or 24" DEEP**

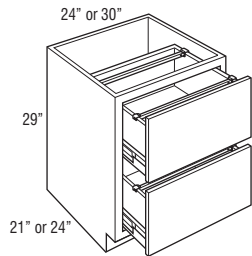

Model	Cubic Feet
DDFD242921	11.9
DDFD302921	14.9
DDFD242924	13.4
DDFD302924	17.9

- Includes Filing System Hardware Kit, which accommodates letter and legal filing.
- Drawers utilize 125 lb. full extension progressive side-mount guide, does not feature soft-close guide.
- Bottom of drawer is not designed to support any weight.
- Exterior height of drawer box is 9 1/2".

**Custom Modifications**

ADDTK	AUTHL AUTHR	CBO	CCO	CFNTO	CFP	CFRMO	CND	DRWSEC	DRWTK	EXBKL EXBKR	EXL EXR
	•*	•	•			•			•	•	•
FB	FFDL FFDR	FPEB	FTK	FTKAV FTKRV	ID	INVERM	LTI	MIP	PFINGTMB	PTOWB	RD
•		•	•	•				•			
RECTKALL RECTKBK	RECTKL RECTKR	RT	TVRAV TVRFV TVRVV	VTK	WLI						
•	•			•	•						

\*Not available on 21" deep

**Construction Upgrades**

APC	PE
•	•

**Door Options**

DPSRR

**DESK WASTEBASKET FULL HEIGHT  
BASE, 29" HIGH, 15" or 18" WIDE,  
21" or 24" DEEP**

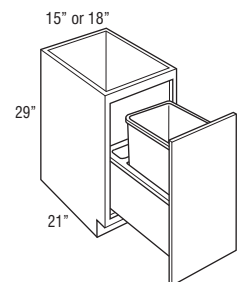

DWB152921FH  
DWB182921FH

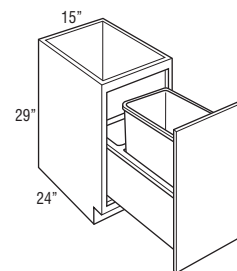

DWB152924FH

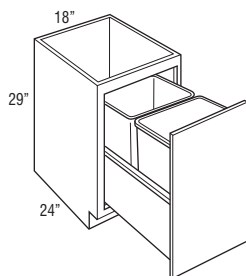

DWB182924FH

DWB152921FH	6.8
DWB182921FH	8.0
DWB152924FH	7.7
DWB182924FH	9.1

- Pull-out features undermount Smart Stop guides.
- DWB152921FH, DWB182921FH, and DWB152924FH include one 35 quart gray wastebasket and a trash bag storage area.
- DWB182924FH includes two 35 quart gray wastebaskets.
- Wastebasket lid available for purchase separately, see page 417. BWBLID fits 35 quart wastebaskets.

**Custom Modifications**

ADDTK	AUTHL AUTHR	CBO	CCO	CFNTO	CFP	CFRMO	CND	DRWSEC	DRWTK	EXBKL EXBKR	EXL EXR
	•*	•	•			•			•*	•	•
FB	FFDL FFDR	FPEB	FTK	FTKAV FTKRV	ID	INVERM	LTI	MIP	PFINGTMB	PTOWB	RD
•		•	•	•				•		•*	
RECTKALL RECTKBK	RECTKL RECTKR	RT	TVRAV TVRFV TVRVV	VTK	WLI						
•	•			•	•						

\*Not available on 21" deep \*Not available on 15" wide

**Construction Upgrades**

APC	PE
•	•

**Door Options**

DPSRR
•

**PRINTER BASE, 29" HIGH, 21" or 24" DEEP**

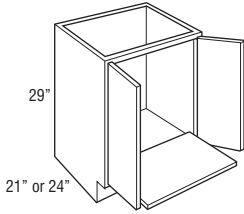

Model	Cubic Feet
PRB242921	11.9
PRB242924	13.6

- 3/4" full depth slide-out shelf with undermount full extension Smart Stop guides.
- 75 lb. maximum shelf capacity.

**Custom Modifications**

ADDTK	AUTHL AUTHR	CBO	CCO	CFNT0	CFP	CFRMO	CND	DRWSEC	DRWTK	EXBKL EXBKR	EXL EXR
	•*	•	•	•		•			•	•	•
FB	FFDL FFDR	FPEB	FTK	FTKAV FTKRV	ID	INVFRM	LTI	MIP	PFINBTMB	PTOWB	RD
•		•	•	•			•	•			•
RECTKALL RECTKBK	RECTKL RECTKR	RT	TVRAV TVRFV TVRVV	VTK	WLI						
•	•	•		•	•						

\*Not available on 21" deep

**Construction Upgrades**

APC	PE
•	•

**Door Options**

DPSRR
•

**DESK EASY REACH, 29" HIGH, 21" or 24" DEEP**

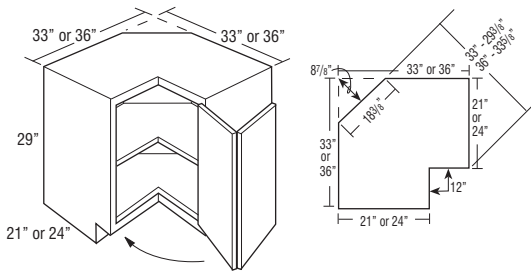

DER333321 L or R	16.0
DER363624 L or R	21.3

- Features one fixed shelf in center of cabinet.
- Decorative hardware screws must be countersunk to prevent scratching of adjacent cabinets and face frame of DER.
- DER333321 L or R wall width is 33" x 33".
- DER363624 L or R wall width is 36" x 36".
- Integrated soft-close hinge not included.
- Cabinet top features I-beam braces with a center support brace.

**Custom Modifications**

ADDTK	AUTHL AUTHR	CBO	CCO	CFNT0	CFP	CFRMO	CND	DRWSEC	DRWTK	EXBKL EXBKR	EXL EXR
		•	•								
FB	FFDL FFDR	FPEB	FTK	FTKAV FTKRV	ID	INVFRM	LTI	MIP	PFINBTMB	PTOWB	RD
•		•					•	•			
RECTKALL RECTKBK	RECTKL RECTKR	RT	TVRAV TVRFV TVRVV	VTK	WLI						
•	•			•	•						

**Construction Upgrades**

APC	PE
•	•

**Door Options**

DPSRR
•

**FURNITURE DRAWER, 6 3/4" HIGH, 24" DEEP**

15", 18", 21", 24", 27", 30", or 36"

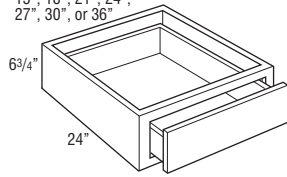

- FD1506.7524
- FD1806.7524
- FD2106.7524
- FD2406.7524
- FD2706.7524
- FD3006.7524
- FD3606.7524

Model	Cubic Feet
FD1506.7524	2.1
FD1806.7524	2.5
FD2106.7524	2.9
FD2406.7524	3.3
FD2706.7524	3.7
FD3006.7524	4.1
FD3606.7524	4.9

- On partial overlay styles, drawer front to face frame is justified to the top to be consistent with current partial overlay reveal of 1". Bottom reveal is 1/4".
- Standard with all-plywood construction and wood dovetail drawer.

**Custom Modifications**

ADDTK	AUTHL AUTHR	CBO	CCO	CFNTO	CFP	CFRMO	CND	DRWSEC	DRWTK	EXBKL EXBKR	EXL EXR
•		•	•			•				•	•
FB	FFDL FFDR	FPEB	FTK	FTKAV FTKRV	ID	INVFRM	LTI	MIP	PFINGTMB	PTOWB	RD
•		•						•			•
RECTKALL RECTKBK	RECTKL RECTKR	RT	TVRAV TVRFV TVRVV	VTK	WLI						

**Construction Upgrades**

APC	PE
STD	

**Door Options**

DPSRR

**FURNITURE DRAWER, 12" HIGH, 24" DEEP**

15", 18", 21", 24", 27", 30", or 36"

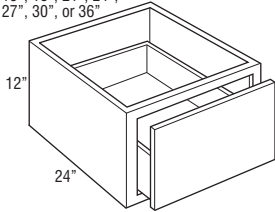

- FD151224
- FD181224
- FD211224
- FD241224
- FD271224
- FD301224
- FD361224

FD151224	3.5
FD181224	4.1
FD211224	4.7
FD241224	5.4
FD271224	6.0
FD301224	6.6
FD361224	7.9

- Drawer front to face frame reveal is justified to the bottom to be consistent with both full overlay and partial overlay. Partial overlay top reveal is 1 1/8" and bottom reveal is 1". Full overlay top reveal is 3/8" and bottom reveal is 1/4".
- Standard with all-plywood construction and wood dovetail drawer.
- Exterior height of drawer box is 6 3/8".

**Custom Modifications**

ADDTK	AUTHL AUTHR	CBO	CCO	CFNTO	CFP	CFRMO	CND	DRWSEC	DRWTK	EXBKL EXBKR	EXL EXR
•		•	•			•				•	•
FB	FFDL FFDR	FPEB	FTK	FTKAV FTKRV	ID	INVFRM	LTI	MIP	PFINGTMB	PTOWB	RD
•		•						•			•
RECTKALL RECTKBK	RECTKL RECTKR	RT	TVRAV TVRFV TVRVV	VTK	WLI						

**Construction Upgrades**

APC	PE
STD	

**Door Options**

DPSRR



**FURNITURE DRAWER WINDOW  
BENCH, 18" HIGH, 24" DEEP**

15", 18", 21", 24",  
27", 30", or 36"

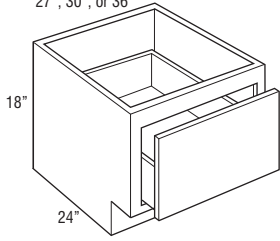

Model	Cubic Feet
FDWB151824	4.9
FDWB181824	5.8
FDWB211824	6.7
FDWB241824	7.6
FDWB271824	8.4
FDWB301824	9.3
FDWB361824	11.1

- Drawer front to face frame reveal is justified to the bottom to be consistent with both full overlay and partial overlay. Partial overlay top reveal is 2 5/8" and bottom reveal is 1". Full overlay top reveal is 1 7/8" and bottom reveal is 1/4".
- Exterior height of drawer box is 6 3/8".

**Custom Modifications**

ADDTK	AUHL AUTHR	CBO	CCO	CFNT0	CFP	CFRMO	CND	DRWSEC	DRWTK	EXBKL EXBKR	EXL EXR
		•	•			•			•*	•	•
FB	FFDL FFDR	FPEB	FTK	FTKAV FTKRV	ID	INVRM	LTI	MIP	PFINBTMB	PTOWB	RD
•		•	•	•				•			•
RECTKALL RECTBK	RECTKL RECTKR	RT	TVRAV TVRFV TVRVV	VTK	WLI						
•	•			•							

\*Not available on 15" wide

**Construction Upgrades**

APC	PE
STD	

**Door Options**

DPSRR
-------

**WOOD TOPS, ONE SIDED, 22 1/2" or  
25 1/2" DEEP**

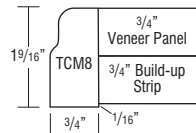
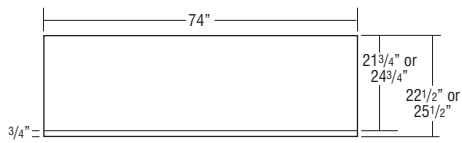
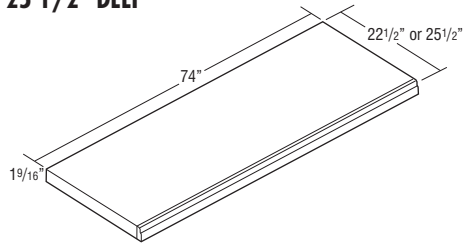

1TWT7221	3.8
1TWT7224	4.2

- 3/4" thick veneer over MDF panels with build-up strips to 1 1/2" thick and Traditional Countertop Moulding (TCM8) on front edge.

**MODIFICATIONS**

No modifications available for these products.

**Construction Upgrades**

APC	PE
•	

**Finish Techniques**

Distressing	Heirlooming
	•

**WOOD TOPS, THREE SIDED, 22 1/2" or 25 1/2" DEEP**

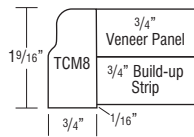
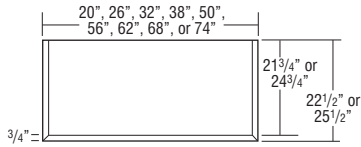
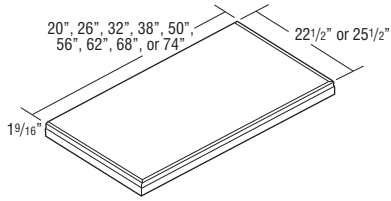

Model	Overall Width	Overall Depth
3TWT1821	20"	22 1/2"
3TWT2421	26"	22 1/2"
3TWT3021	32"	22 1/2"
3TWT3621	38"	22 1/2"
3TWT4821	50"	22 1/2"
3TWT5421	56"	22 1/2"
3TWT6021	62"	22 1/2"
3TWT6621	68"	22 1/2"
3TWT7221	74"	22 1/2"

Model	Overall Width	Overall Depth
3TWT1824	20"	25 1/2"
3TWT2424	26"	25 1/2"
3TWT3024	32"	25 1/2"
3TWT3624	38"	25 1/2"
3TWT4824	50"	25 1/2"
3TWT5424	56"	25 1/2"
3TWT6024	62"	25 1/2"
3TWT6624	68"	25 1/2"
3TWT7224	74"	25 1/2"

Model	Cubic Feet
3TWT1821	1.1
3TWT2421	1.4
3TWT3021	1.7
3TWT3621	2.0
3TWT4821	2.6
3TWT5421	2.9
3TWT6021	3.2
3TWT6621	3.5
3TWT7221	3.8
3TWT1824	1.2
3TWT2424	1.6
3TWT3024	1.9
3TWT3624	2.2
3TWT4824	2.9
3TWT5424	3.2
3TWT6024	3.6
3TWT6624	3.9
3TWT7224	4.2

- 3/4" thick veneer over MDF panels with build-up strips to 1 1/2" thick and Traditional Countertop Moulding (TCM8) on front and side edges.

**MODIFICATIONS**

No modifications available for these products.

**Construction Upgrades**

APC	PE
•	

**Finish Techniques**

Distressing	Heirlooming
	•

**WOOD TOPS, FOUR SIDED, 27" or 33" DEEP**

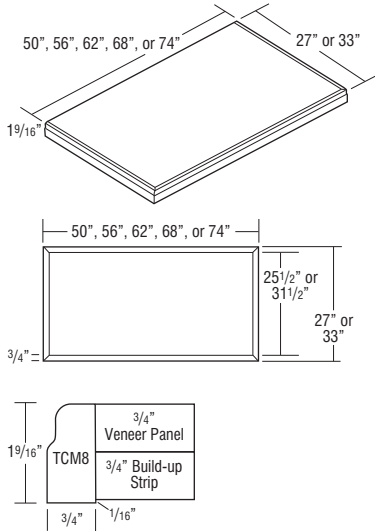

Model	Overall Width	Overall Depth
4TWT4827	50"	27"
4TWT5427	56"	27"
4TWT6027	62"	27"
4TWT6627	68"	27"
4TWT7227	74"	27"

Model	Overall Width	Overall Depth
4TWT4833	50"	33"
4TWT5433	56"	33"
4TWT6033	62"	33"
4TWT6633	68"	33"
4TWT7233	74"	33"

Model	Cubic Feet
4TWT4827	3.1
4TWT5427	3.4
4TWT6027	3.8
4TWT6627	4.1
4TWT7227	4.5
4TWT4833	3.7
4TWT5433	4.1
4TWT6033	4.5
4TWT6633	5.0
4TWT7233	5.4

• 3/4" thick veneer over MDF panels with build-up strips to 1 1/2" thick and Traditional Countertop Moulding (TCM8) on front, back, and side edges.

**MODIFICATIONS**  
No modifications available for these products.

**Construction Upgrades**

APC	PE
•	

**Finish Techniques**

Distressing	Heirlooming
	•

**UNDER COUNTER DRAWER, 4 3/4" HIGH, 18" or 21" DEEP**

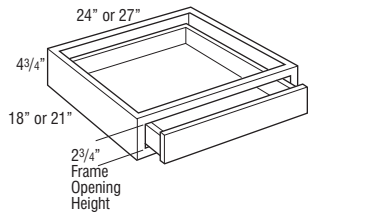

UCD2418 UCD2421  
UCD2718 UCD2721

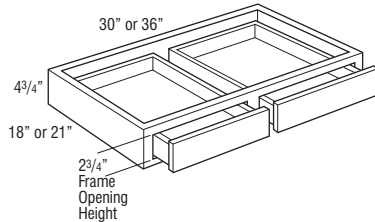

UCD3018 UCD3021  
UCD3618 UCD3621

UCD2418	2.6
UCD2718	2.6
UCD2421	2.6
UCD2721	2.6
UCD3018	2.6
UCD3618	2.6
UCD3021	2.6
UCD3621	2.6

- Cabinet is 4 3/4" high. Drawer box within cabinet is 2" high (outside dimension).
- Not trimmable.
- Drawer front is 3/4" slab front.
- The frame to end panel offset is 3/4", which is designed to accommodate the vanity desk leg.
- End panels ordered in Distinction will feature non-matching laminate exterior. When ordered in PE or APC, end panels will not be finished.
- Reduced depth is available in 3" increments.

**Custom Modifications**

ADDTK	AUTHL AUTHR	CBO	CCO	CFNTO	CFP	CFRMO	CND	DRWSEC	DRWTK	EXBKL EXBKR	EXL EXR
		•	•			•					•
FB	FFDL FFDR	FPEB	FTK	FTKAV FTKRV	ID	INVRM	LTI	MIP	PFINBTAB	PTOWB	RD
					•			•			•
RECTKALL RECTKBK	RECTKLL RECTKRR	RT	TVRAV TVRFV TVRVV	VTK	WLI						

**Construction Upgrades**

APC	PE
•	•

**Door Options**

DPSRR
-------

# Diamond<sup>®</sup>

## DISTINCTION™ SERIES

314

### VANITY CABINET NOMENCLATURE

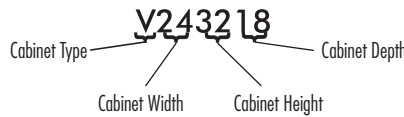

**NOTE:**  
If order is placed in Arch door style, vanity bases will have Square doors and vanity utilities and linen closets will have an Arch top door and Square lower doors.

Distance between back of drawer box and back interior of cabinet is 2 3/4".

All vanity cabinets are predrilled for full depth shelves or roll trays.

### TOEKICKS

Vanity Cabinets are shipped with an unfinished toekick. Finished toekicks in matching wood veneer or laminate must be ordered separately and field installed.

### MODIFICATIONS GRID KEY

- Available
- STD Standard on these cabinets
- L O G I X Logix® Organization Cabinet



5 Day Express Response Item

### CUSTOM MODIFICATIONS

Mod.	Description	Mod.	Description	Mod.	Description
AUTHL	Authentic End - Left	EXBKR	End Extended Back - Right	LTI	Light Installed Battery Strip
AUTHR	Authentic End - Right	EXL	Extended Stile - Left	MIP	Matching Interior Plywood
CBO	Cabinet Box Only	EXR	Extended Stile - Right	RD	Reduced Depth
CCO	Cabinet Case Only	FB	Finished Ends	RECTKALL	Recessed Island Toekick
CFNTO	Cabinet Front Only	FFDL	Face Frame and Door on End - Left	RECTKBK	Recessed Toekick - Back
CFP	Cabinet False Panel	FFDR	Face Frame and Door on End - Right	RECTKL	Recessed Toekick - Left
CFRMO	Cabinet Frame Only	FPEB	Furniture Finished Plywood Ends	RECTKR	Recessed Toekick - Right
CMAT	CabMat™	FTK	Flush Toekick	RT	Installed Roll Tray
CND	Cabinet with No Door, with Drawer	FTKAV	Flush Toekick Arch	TKP	Loose Toekick
DRWPWR	PowerGlide™ Compact Drawer Outlet	FTKAV	Flush Toekick Arch	TOTSS	Tilt-out Tray, Stainless Steel
DRWTK	Toekick Drawer	FTKFV	Flush Toekick Furniture	TOTSSS	Tilt-out Tray, Stainless Steel Slim
EXBKL	End Extended Back - Left	ID	Increased Depth	VTK	Void Toekick
		INVFRM	Inverted Frame	WLI	White Laminate Interior

### CONSTRUCTION UPGRADES

Mod.	Description
APC	All-plywood Construction
PE	Plywood Ends

### DOOR OPTIONS

Mod.	Description
ALF	Aluminum Frame Doors
CG	Cut-for-glass Doors
DPSRR	Door Panel - Solid Reverse Raised
MD	Mullion Doors
MFO	Modified Full Overlay

Model	Cubic Feet	Model	Cubic Feet
V123218 L or R	5.6	V243218	10.4
V153218 L or R	6.8	V273218	11.6
V183218 L or R	8.0	V303218	12.7
V213218 L or R	9.2	V333218	13.9
V243218 L or R	10.4	V363218	15.1
V123221 L or R	6.4	V243221	11.9
V153221 L or R	7.8	V273221	13.3
V183221 L or R	9.2	V303221	14.6
V213221 L or R	10.6	V333221	16.0
V243221 L or R	11.9	V363221	17.4

### VANITY BASE, 32" HIGH, 18" or 21" DEEP

12", 15", 18", 21", or 24"

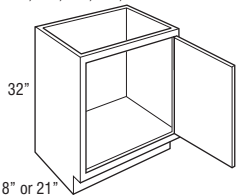

- V123218 L or R
- V153218 L or R
- V183218 L or R
- V213218 L or R
- V243218 L or R
- V123221 L or R
- V153221 L or R
- V183221 L or R
- V213221 L or R
- V243221 L or R

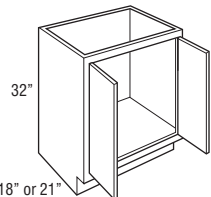

- V243218
- V273218
- V303218
- V333218
- V363218
- V243221
- V273221
- V303221
- V333221
- V363221

### Custom Modifications

AUTHL	AUTHR	CBO	CCO	CFNTO	CFP	CFRMO	CMAT	CND	DRWPWR	DRWTK	EXBKL	EXL	EXBKR	EXR
•			•	•		•	•*			•+	•	•	•	•
		FFDL		FTK	FTKAV			INVFRM	LTI	MIP	RD	RECTKALL	RECTKBK	RECTKL
•	•	•	•	•	•▲	•		•▲	•	•	•	•	•	•
			TOTSS	VTK	WLI									
•				•	•									

\*Not available on 12", 15", 18", and 21" wide, or on 18" deep \*Not available on 12" and 15" wide, or on 18" deep

▲Not available on 12" wide

### Construction Upgrades

APC	PE
•	•

### Door Options

ALF	CG	DPSRR	MD	MFO
		•		

VANITY CABINETS

**VANITY BASE, 32" HIGH,  
18" or 21" DEEP (cont'd)**

39", 42", 45", or 48"

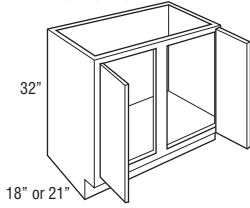

V393218 V393221  
V423218 V423221  
V453218 V453221  
V483218CS V483221CS

48" or 60"

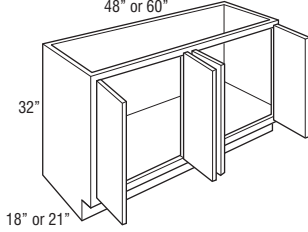

V483218 V483221  
V603218 V603221

Model	Cubic Feet
V393218	16.5
V423218	17.5
V453218	18.5
V483218CS	19.9
V393221	18.9
V423221	20.1
V453221	21.3
V483221CS	22.9
V483218	19.9
V603218	28.6
V483221	22.9
V603221	25.0

**Custom Modifications**

AUTHL	AUTHR	CBO	CCO	CFNTO	CFP	CFRMO	CMAT	CND	DRWPWR	DRWTK	EXBKL	EXL
•			•	•		•	•*				•	•
	FFDL	FPEB	FTK	FTKAV							RECTKALL	RECTKL
FB	FFDR	FPEB	FTK	FTKFV	ID	INVFRM	LTI	MIP	RD		RECTKBK	RECTKR
•	•	•	•	•	•		•	•	•	•	•	•
		TOTSS										
RT	TKP	TOTSSS	VTK	WLI								
•			•	•								

\*Not available on 39", 42", and 45" wide, or on 18" deep

**Construction Upgrades**

APC	PE
•	•

**Door Options**

ALF	CG	DPSRR	MD	MFO
		•		

**VANITY BASE, 34 1/2" HIGH,  
18" or 21" DEEP**

12", 15", 18", 21", or 24"

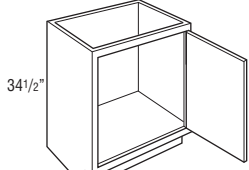

V123418 L or R V123421 L or R  
V153418 L or R V153421 L or R  
V183418 L or R V183421 L or R  
V213418 L or R V213421 L or R  
V243418 L or R V243421 L or R

18" or 21"  
24", 27", 30", 33", or 36"

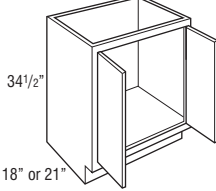

V243418 V243421  
V273418 V273421  
V303418 V303421  
V333418 V333421  
V363418 V363421

18" or 21"

39", 42", 45", or 48"

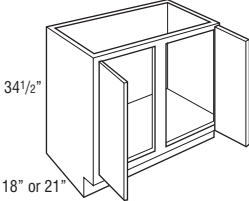

V393418 V393421  
V423418 V423421  
V453418 V453421  
V483418CS V483421CS

18" or 21"

48" or 60"

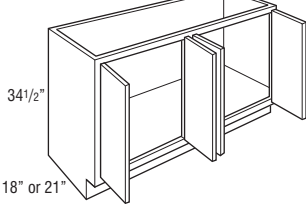

V483418 V483421  
V603418 V603421

18" or 21"

Model	Cubic Feet	Model	Cubic Feet
V123418 L or R	5.8	V393418	17.3
V153418 L or R	7.1	V423418	18.6
V183418 L or R	8.3	V453418	19.9
V213418 L or R	9.6	V483418CS	21.1
V243418 L or R	10.9	V393421	22.3
V123421 L or R	6.8	V423421	24.4
V153421 L or R	8.2	V453421	25.2
V183421 L or R	9.7	V483421CS	27.7
V213421 L or R	11.2		
V243421 L or R	14.4	V483418	21.1
		V603418	26.3
V243418	10.9	V483421	27.7
V273418	12.2	V603421	30.3
V303418	13.5		
V333418	14.7		
V363418	16.0		
V243421	14.4		
V273421	16.1		
V303421	17.7		
V333421	19.6		
V363421	21.1		

**Custom Modifications**

AUTHL	CBO	CCO	CFNTO	CFP	CFRMO	CMAT	CND	DRWPWR	DRWTK	EXBKL	EXL
AUTHR										EXBKR	EXR
•		•	•		•	•*			•*	•	•
FB	FFDL		FTK	FTKAV						RECTKALL	RECTKL
•	FFDR	FPEB	FTK	FTKAV	ID	INVFRM	LTI	MIP	RD	RECTKBK	RECTKR
•	•	•	•	•*	•		•*	•	•	•	•
RT	TKP	TOTSS	VTK	WLI							
•		TOTSS	•	•							

\*Not available on 12", 15", 18", 21", 39", 42", and 45" wide, or on 18" deep

\*Not available on 12", 15", 39", 42", 45", 48" and 60" wide, or on 18" deep

\*Not available on 12" wide

**Construction Upgrades**

APC	PE
•	•

**Door Options**

ALF	CG	DPSRR	MD	MFO
		•		

**VANITY SINK BASE with FALSE PANEL,  
32" HIGH, 18" or 21" DEEP**

15", 18", 21", or 24"

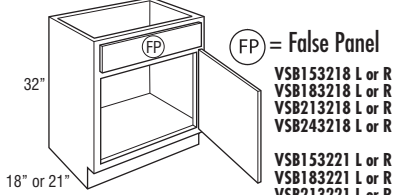

(FP) = False Panel  
**VSB153218 L or R**  
**VSB183218 L or R**  
**VSB213218 L or R**  
**VSB243218 L or R**

**VSB153221 L or R**  
**VSB183221 L or R**  
**VSB213221 L or R**  
**VSB243221 L or R**

24", 27", 30", 33", or 36"

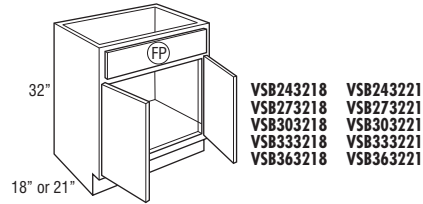

**VSB243218** **VSB243221**  
**VSB273218** **VSB273221**  
**VSB303218** **VSB303221**  
**VSB333218** **VSB333221**  
**VSB363218** **VSB363221**

39", 42", 45", or 48"

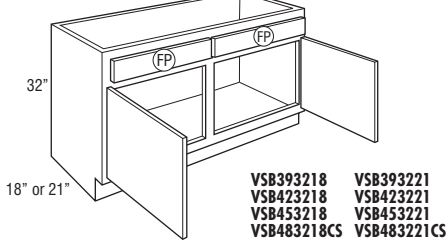

**VSB393218** **VSB393221**  
**VSB423218** **VSB423221**  
**VSB453218** **VSB453221**  
**VSB483218CS** **VSB483221CS**

48"

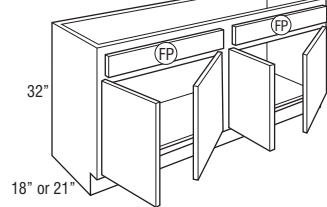

**VSB483218**  
**VSB483221**

Model	Cubic Feet	Model	Cubic Feet
<b>VSB153218 L or R</b>	6.8	<b>VSB393218</b>	16.5
<b>VSB183218 L or R</b>	8.0	<b>VSB423218</b>	17.5
<b>VSB213218 L or R</b>	9.2	<b>VSB453218</b>	18.5
<b>VSB243218 L or R</b>	10.4	<b>VSB483218CS</b>	19.9
<b>VSB153221 L or R</b>	7.8	<b>VSB393221</b>	18.9
<b>VSB183221 L or R</b>	9.2	<b>VSB423221</b>	20.1
<b>VSB213221 L or R</b>	10.6	<b>VSB453221</b>	21.3
<b>VSB243221 L or R</b>	11.9	<b>VSB483221CS</b>	22.9
<b>VSB243218</b>	10.4	<b>VSB483218</b>	19.9
<b>VSB273218</b>	11.6	<b>VSB483221</b>	22.9
<b>VSB303218</b>	12.7		
<b>VSB333218</b>	13.9		
<b>VSB363218</b>	15.1		
<b>VSB243221</b>	11.9		
<b>VSB273221</b>	13.3		
<b>VSB303221</b>	14.6		
<b>VSB333221</b>	16.0		
<b>VSB363221</b>	17.4		

**Custom Modifications**

AUTHL	AUTHR	CBO	CCO	CFNTO	CFP	CFRMO	CMAT	CND	DRWPWR	DRWTK	EXBKL	EXL	EXBKR	EXR
•			•	•	STD	•	•*	•		•*	•	•		
FB	FFDL FFDR	FPEB	FTK	FTKAV FTKFV	ID	INVRM	LTI	MIP	RD	RECTKALL RECTKBK	RECTKL RECTKR			
•	•	•	•	•	•		•	•	•	•	•	•		
RT	TKP	TOTSS TOTSSS	VTK	WLI										
•		•	•	•										

\*Not available on 15", 18", 21", 39", 42", and 45" wide, or on 18" deep

\*Not available on 15", 39", 42" and 48" wide, or on 18" deep

**Construction Upgrades**

APC	PE
•	•

**Door Options**

ALF	CG	DPSRR	MD	MFO
		•		

**VANITY SINK BASE with FALSE PANEL,  
34 1/2" HIGH, 18" or 21" DEEP**

15", 18", 21", or 24"

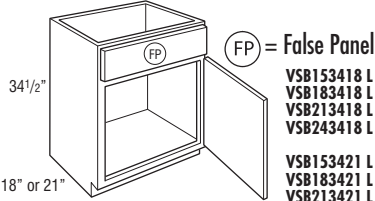

VSB153418 L or R  
VSB183418 L or R  
VSB213418 L or R  
VSB243418 L or R

VSB153421 L or R  
VSB183421 L or R  
VSB213421 L or R  
VSB243421 L or R

24", 27", 30", 33", or 36"

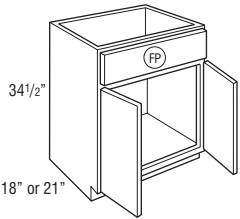

VSB243418 VSB243421  
VSB273418 VSB273421  
VSB303418 VSB303421  
VSB333418 VSB333421  
VSB363418 VSB363421

39", 42", 45", or 48"

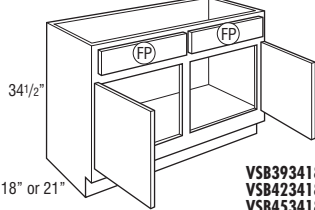

VSB393418 VSB393421  
VSB423418 VSB423421  
VSB453418 VSB453421  
VSB483418CS VSB483421CS

48"

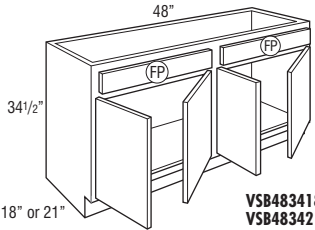

VSB483418  
VSB483421

Model	Cubic Feet	Model	Cubic Feet
VSB153418 L or R	7.1	VSB393418	17.3
VSB183418 L or R	8.3	VSB423418	18.6
VSB213418 L or R	9.6	VSB453418	19.9
VSB243418 L or R	10.9	VSB483418CS	21.1
VSB153421 L or R	8.2	VSB393421	22.3
VSB183421 L or R	9.7	VSB423421	24.4
VSB213421 L or R	11.2	VSB453421	25.2
VSB243421 L or R	14.4	VSB483421CS	27.7

VSB243418	10.9
VSB273418	12.2
VSB303418	13.5
VSB333418	14.7
VSB363418	16.0
VSB243421	14.4
VSB273421	16.1
VSB303421	17.7
VSB333421	19.6
VSB363421	21.1

**Custom Modifications**

AUTHL	AUTHR	CBO	CCO	CFNT0	CFP	CFRMO	CMAT	CND	DRWPWR	DRWTK	EXBKL	EXL	
•			•	•	STD	•	•*	•		•+	•	•	
FB	FFDL	FFDR	FPEB	FTK	FTKAV	FTKVV	ID	INVFRM	LTI	MIP	RD	RECTKLL	RECTKL
•	•	•	•	•	•	•		•	•	•	•	•	
RT	TKP	TOTSS	TOTSSS	VTK	WLI								
•		•	•	•	•								

\*Not available on 15", 18", 21", 39", 42", and 45" wide, or on 18" deep

\*Not available on 15", 39", 42" and 48" wide, or on 18" deep

**Construction Upgrades**

APC	PE
•	•

**Door Options**

ALF	CG	DPSRR	MD	MFO
		•		



**VANITY SINK BASE with U-SHAPED ROLL-OUT TRAY, 32" HIGH, 21" DEEP**

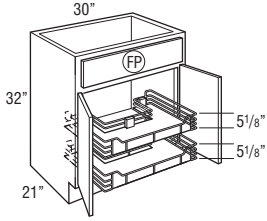

L G I X

Model	Cubic Feet
<b>VSB303221U</b>	<b>14.6</b>

- Includes two chrome U-shaped Smart Stop roll-outs with gray shelf liner.
- Cut-out for U-shape on bottom roll-out is 6 1/8" from back of cabinet.
- Cut-out for U-shape on top roll-out is 12 1/8" from back of cabinet.
- Trays are 25 21/32" wide and 17 23/32" deep.

**Custom Modifications**

AUTHL AUTHR	CBO	CCO	CFNT0	CFP	CFRMO	CMAT	CND	DRWPWR	DRWTK	EXBKL EXBKR	EXL EXR
•	•	•	•	STD	•		•		•	•	•
FB	FFDL FFDR	FPEB	FTK	FTKAV FTKFV	ID	INVFRM	LTI	MIP	RD	RECTKALL RECTKBK	RECTKL RECTKR
•		•	•	•	•		•	•		•	•
RT	TKP	TOTSS TOTSSS	VTK	WLI							
		•	•	•							

**Construction Upgrades**

APC	PE
•	•

**Door Options**

ALF	CG	DPSRR	MD	MFO
		•		

**VANITY SINK BASE with U-SHAPED ROLL-OUT TRAY, 34 1/2" HIGH, 21" DEEP**

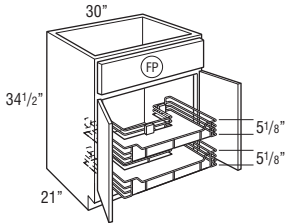

L G I X

Model	Cubic Feet
<b>VSB303421U</b>	<b>17.7</b>

- Includes two chrome U-shaped Smart Stop roll-outs with gray shelf liner.
- Cut-out for U-shape on bottom roll-out is 6 1/8" from back of cabinet.
- Cut-out for U-shape on top roll-out is 12 1/8" from back of cabinet.
- Trays are 25 21/32" wide and 17 23/32" deep.

**Custom Modifications**

AUTHL AUTHR	CBO	CCO	CFNT0	CFP	CFRMO	CMAT	CND	DRWPWR	DRWTK	EXBKL EXBKR	EXL EXR
•	•	•	•	STD	•		•		•	•	•
FB	FFDL FFDR	FPEB	FTK	FTKAV FTKFV	ID	INVFRM	LTI	MIP	RD	RECTKALL RECTKBK	RECTKL RECTKR
•		•	•	•	•		•	•		•	•
RT	TKP	TOTSS TOTSSS	VTK	WLI							
		•	•	•							

**Construction Upgrades**

APC	PE
•	•

**Door Options**

ALF	CG	DPSRR	MD	MFO
		•		

**VANITY SINK BASE with WASTEBASKET, 34 1/2" HIGH, 21" DEEP**

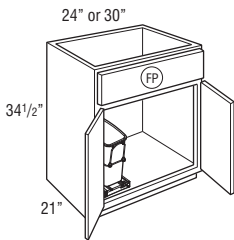

L G I X

Model	Cubic Feet
<b>VSB243421WB L or R</b>	<b>14.4</b>
<b>VSB303421WB L or R</b>	<b>17.7</b>

- Bottom mounted zinc colored Smart Stop guides with 20 quart gray wastebasket inserted in chrome support.
- Dimensions of unit: 8.5"W x 16.7"H x 17.7"D.
- L or R designates wastebasket location.

**Custom Modifications**

AUTHL AUTHR	CBO	CCO	CFNT0	CFP	CFRMO	CMAT	CND	DRWPWR	DRWTK	EXBKL EXBKR	EXL EXR
•	•	•	•	STD	•		•		•	•	•
FB	FFDL FFDR	FPEB	FTK	FTKAV FTKFV	ID	INVFRM	LTI	MIP	RD	RECTKALL RECTKBK	RECTKL RECTKR
•		•	•	•	•		•	•		•	•
RT	TKP	TOTSS TOTSSS	VTK	WLI							
		•	•	•							

**Construction Upgrades**

APC	PE
•	•

**Door Options**

ALF	CG	DPSRR	MD	MFO
		•		

**VANITY SINK BASE SUPERCABINET™**  
with TILT-OUT TRAYS and  
WASTEBASKET, 34 1/2" HIGH,  
21" DEEP

L O G I X

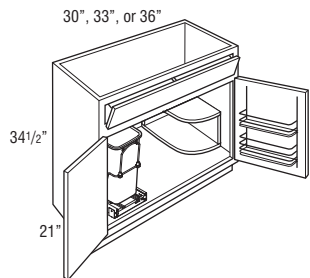

Model	Cubic Feet
VSSB303421STWB L or R	17.7
VSSB333421STWB L or R	19.6
VSSB363421STWB L or R	21.1

- Quarter Round Reversible Shelf for left or right applications will be constructed from 3/4" thick laminated furniture board. When upgraded to APC, shelf will use clear coated veneer plywood. (Shelf shipped secure, can be positioned in left or right corner.)
- Door on the side with the Quarter Round Shelf features a chrome and wood two-tiered rack.
- Door rack width is 11 3/8" on 30" and 33" wide cabinets and 14 3/8" on 36" wide cabinet.
- Door rack depth is 3 1/2".
- Includes 2 installed tilt-out trays.
- Tilt-out trays are stain resistant, moisture resistant plastic to allow storage of sponges & other cleaning materials.
- Tilt-out trays are also available as an accessory for field installation. See page 423.
- All load bearing service meet KCMA standards of 15 lbs. per square foot.
- Bottom mounted zinc colored Smart Stop guides with 20 quart gray wastebasket inserted in chrome support. Dimensions of unit: 8.5"W x 16.7"H x 17.7"D.
- L or R designates wastebasket location.

**Custom Modifications**

AUTHL AUTHR	CBO	CCO	CFNT0	CFP	CFRMO	CMAT	CND	DRWPWR	DRWTK	EXBKL EXBKR	EXL EXR
•	•	•	•		•		•		•	•	•
FB	FFDL FFDR	FPEB	FTK	FTKAV FTKFV	ID	INVFRM	LTI	MIP	RD	RECTKALL RECTKBK	RECTKL RECTKR
•		•	•	•	•		•	•		•	•
RT	TKP	TOTSS TOTSSS	VTK	WLI							
			•	•							

**Construction Upgrades**

APC	PE
•	•

**Door Options**

ALF	CG	DPSRR	MD	MFO
		•		

**VANITY SINK BASE SUPERCABINET™**  
with TILT-OUT TRAYS, 34 1/2" HIGH,  
21" DEEP

L O G I X

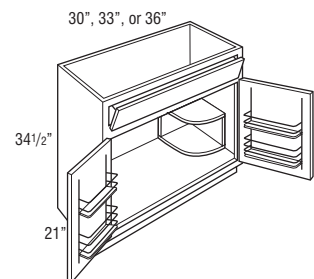

VSSB303421ST	17.7
VSSB333421ST	19.6
VSSB363421ST	21.1

- Quarter Round Reversible Shelf for left or right applications will be constructed from 3/4" thick laminated furniture board. When upgraded to APC, shelf will use clear coated veneer plywood. (Shelf shipped secure, can be positioned in left or right corner.)
- Each door features a chrome and wood two-tiered rack.
- Door rack width is 11 3/8" on 30" and 33" wide cabinets and 14 3/8" on 36" wide cabinet.
- Door rack depth is 3 1/2".
- Includes 2 installed tilt-out trays.
- Tilt-out trays are stain resistant, moisture resistant plastic to allow storage of sponges & other cleaning materials.
- Tilt-out trays are also available as an accessory for field installation. See page 423.
- All load bearing service meet KCMA standards of 15 lbs. per square foot.

**Custom Modifications**

AUTHL AUTHR	CBO	CCO	CFNT0	CFP	CFRMO	CMAT	CND	DRWPWR	DRWTK	EXBKL EXBKR	EXL EXR
•	•	•	•		•		•		•	•	•
FB	FFDL FFDR	FPEB	FTK	FTKAV FTKFV	ID	INVFRM	LTI	MIP	RD	RECTKALL RECTKBK	RECTKL RECTKR
•		•	•	•	•		•	•		•	•
RT	TKP	TOTSS TOTSSS	VTK	WLI							
			•	•							

**Construction Upgrades**

APC	PE
•	•

**Door Options**

ALF	CG	DPSRR	MD	MFO
		•		

**VANITY BASE, SINGLE DOOR with DRAWER, 32" HIGH, 18" or 21" DEEP**

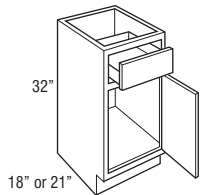

Model	Cubic Feet
VB123218 L or R	5.6
VB153218 L or R	6.8
VB183218 L or R	8.0
VB213218 L or R	9.2
VB243218 L or R	10.5
VB123221 L or R	6.4
VB153221 L or R	7.8
VB183221 L or R	9.1
VB213221 L or R	10.8
VB243221 L or R	11.9

**Custom Modifications**

AUTHL	AUTHR	CBO	CCO	CFNT0	CFP	CFRMO	CMAT	CND	DRWPWR	DRWTK	EXBKL	EXL	EXBKR	EXR
•	•	•	•	•	•	•		•		•*	•	•		
FB	FFDL	FFDR	FPEB	FTK	FTKAV	FTKFV	ID	INVRM	LTI	MIP	RD	RECTKALL	RECTKALL	RECTKLR
•	•	•	•	•	•+	•	•	•	•+	•	•	•	•	•
RT	TKP	TOTSS	TOTSSS	VTK	WLI									
•				•	•									

\*Not available on 12" and 15" wide, or on 18" deep \*Not available on 12" wide

**Construction Upgrades**

APC	PE
•	•

**Door Options**

ALF	CG	DPSRR	MD	MFO
		•		

**VANITY BASE, SINGLE DOOR with DRAWER, 34 1/2" HIGH, 18" or 21" DEEP**

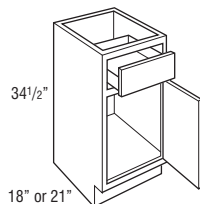

VB123418 L or R	5.8
VB153418 L or R	7.1
VB183418 L or R	8.3
VB213418 L or R	9.6
VB243418 L or R	10.9
VB123421 L or R	7.8
VB153421 L or R	9.4
VB183421 L or R	11.1
VB213421 L or R	12.8
VB243421 L or R	14.4

**Custom Modifications**

AUTHL	AUTHR	CBO	CCO	CFNT0	CFP	CFRMO	CMAT	CND	DRWPWR	DRWTK	EXBKL	EXL	EXBKR	EXR
•	•	•	•	•	•	•		•	•*	•+	•	•		
FB	FFDL	FFDR	FPEB	FTK	FTKAV	FTKFV	ID	INVRM	LTI	MIP	RD	RECTKALL	RECTKALL	RECTKLR
•	•	•	•	•	•▲	•	•	•	•▲	•	•	•	•	•
RT	TKP	TOTSS	TOTSSS	VTK	WLI									
•				•	•									

\*Not available on 12" and 15" wide \*Not available on 12" and 15" wide, or on 18" deep

▲Not available on 12" wide

**Construction Upgrades**

APC	PE
•	•

**Door Options**

ALF	CG	DPSRR	MD	MFO
		•		

**VANITY BASE, DOUBLE DOOR with DRAWER, 32" HIGH, 18" or 21" DEEP**

24", 27", 30", 33", or 36"

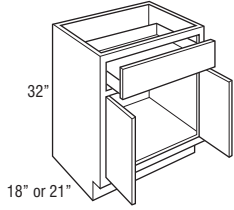

- VB243218 VB243221
- VB273218 VB273221
- VB303218 VB303221
- VB333218 VB333221
- VB363218 VB363221

39", 42", 45", or 48"

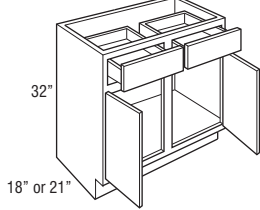

- VB393218 VB393221
- VB423218 VB423221
- VB453218 VB453221
- VB483218CS VB483221CS

48"

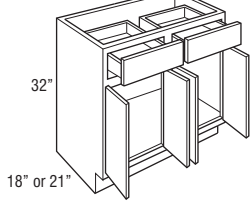

- VB483218
- VB483221

Model	Cubic Feet
VB243218	10.4
VB273218	11.7
VB303218	12.9
VB333218	14.1
VB363218	15.3
VB243221	11.9
VB273221	13.3
VB303221	14.7
VB333221	16.1
VB363221	17.5
VB393218	16.5
VB423218	17.7
VB453218	18.5
VB483218CS	20.2
VB393221	18.9
VB423221	20.3
VB453221	21.3
VB483221CS	23.1
VB483218	20.2
VB483221	23.1

**Custom Modifications**

AUTHL	CBO	CCO	CFNTO	CFP	CFRMO	CMAT	CND	DRWPWR	DRWTK	EXBKL	EXL
AUTHR										EXBKR	EXR
•	•	•	•	•	•		•	•	•*	•	•
FB	FFDL		FTK	FTKAV						RECTKALL	RECTKL
	FFDR	FPEB	FTK	FTKFV	ID	INVFRM	LTI	MIP	RD	RECTKBK	RECTKR
•	•	•	•	•	•	•	•	•	•	•	•
RT	TKP	TOTSS	VTK	WLI							
•		TOTSSS									
			•	•							

\*Not available on 39", 42", 45" and 48" wide, or on 18" deep

**Construction Upgrades**

APC	PE
•	•

**Door Options**

ALF	CG	DPSRR	MD	MFO
		•		

**VANITY BASE, DOUBLE DOOR with DRAWER, 34 1/2" HIGH, 18" or 21" DEEP**

24", 27", 30", 33", or 36"

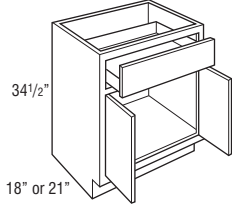

VB243418 VB243421  
 VB273418 VB273421  
 VB303418 VB303421  
 VB333418 VB333421  
 VB363418 VB363421

39", 42", 45", or 48"

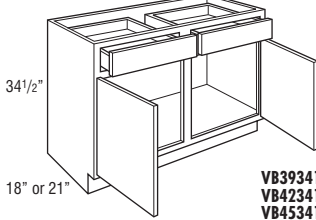

VB393418 VB393421  
 VB423418 VB423421  
 VB453418 VB453421  
 VB483418CS VB483421CS

48"

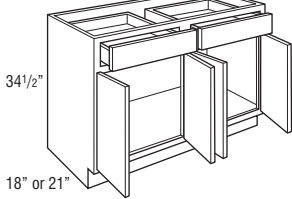

VB483418  
 VB483421

Model	Cubic Feet	Model	Cubic Feet
VB243418	10.9	VB393418	17.3
VB273418	12.2	VB423418	18.6
VB303418	13.5	VB453418	19.9
VB333418	14.7	VB483418CS	21.1
VB363418	16.0	VB393421	22.3
VB243421	14.4	VB423421	24.4
VB273421	16.1	VB453421	25.2
VB303421	17.7	VB483421CS	27.7
VB333421	19.6		
VB363421	21.1	VB483418	21.1
		VB483421	27.7

**Custom Modifications**

AUTHL	CBO	CCO	CFNTO	CFP	CFRMO	CMAT	CND	DRWPWR	DRWTK	EXBKL	EXL	
AUTHR										EXBKR	EXR	
									*			
FB	FFDL	FPEB	FTK	FTKAV	FTKFV	ID	INVFRM	LTI	MIP	RD	RECTKLL	RECTKL
	FFDR										RECTKBK	RECTKR
RT	TKP	TOTSS	TOTSSS	VTK	WLI							

\*Not available on 39", 42", 45" and 48" wide, or on 18" deep

**Construction Upgrades**

APC	PE

**Door Options**

ALF	CG	DPSRR	MD	MFO

**VANITY BASE EASY REACH, 32" HIGH, 18" or 21" DEEP**

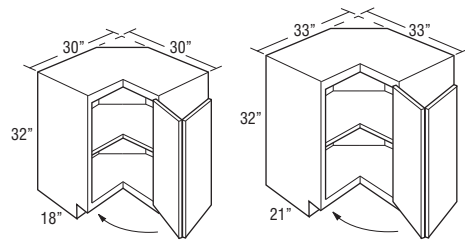

VER303218 L or R	12.9
VER333221 L or R	16.1

- Decorative hardware screws must be countersunk to prevent scratching adjacent cabinets and face frame of VER.
- Includes one 1/2" thick fixed shelf in center of cabinet.
- Integrated soft-close hinge not included.
- Cabinet top features I-beam braces with a center support brace.

**Custom Modifications**

AUTHL	CBO	CCO	CFNTO	CFP	CFRMO	CMAT	CND	DRWPWR	DRWTK	EXBKL	EXL	
AUTHR										EXBKR	EXR	
FB	FFDL	FPEB	FTK	FTKAV	FTKFV	ID	INVFRM	LTI	MIP	RD	RECTKLL	RECTKL
	FFDR										RECTKBK	RECTKR
RT	TKP	TOTSS	TOTSSS	VTK	WLI							

**Construction Upgrades**

APC	PE

**Door Options**

ALF	CG	DPSRR	MD	MFO

**VANITY BASE EASY REACH,  
34 1/2" HIGH, 21" DEEP**

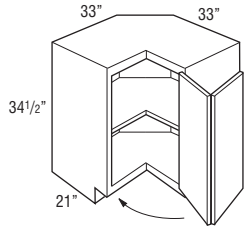

Model	Cubic Feet
VER333421 L or R	17.1

- Decorative hardware screws must be countersunk to prevent scratching adjacent cabinets and face frame of VER.
- Includes one 1/2" thick fixed shelf in center of cabinet.
- Integrated soft-close hinge not included.
- Cabinet top features I-beam braces with a center support brace.

**Custom Modifications**

AUTHL	CBO	CCO	CFNTO	CFP	CFRMO	CMAT	CND	DRWPWR	DRWTK	EXBKL	EXL	
	•	•										
FB	FFDL	FPEB	FTK	FTKAV	FTKRV	ID	INVFRM	LTI	MIP	RD	RECTKALL	RECTKL
		•						•	•		•	•
RT	TKP	TOTSS	TOTSSS	VTK	WLI							
				•	•							

**Construction Upgrades**

APC	PE
•	•

**Door Options**

ALF	CG	DPSRR	MD	MFO
		•		

**VANITY DRAWER BASE,  
32" HIGH, 18" or 21" DEEP**

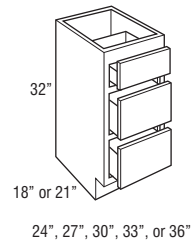

VDB123218 VDB123221  
VDB153218 VDB153221  
VDB183218 VDB183221  
VDB213218 VDB213221

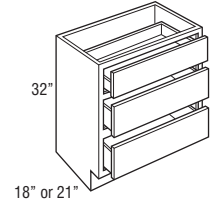

VDB243218 VDB243221  
VDB273218 VDB273221  
VDB303218 VDB303221  
VDB333218 VDB333221  
VDB363218 VDB363221

VDB123218	5.6
VDB153218	6.8
VDB183218	8.0
VDB213218	9.2
VDB123221	6.4
VDB153221	7.8
VDB183221	9.1
VDB213221	10.5

VDB243218	10.4
VDB273218	11.4
VDB303218	12.6
VDB333218	13.8
VDB363218	15.0
VDB243221	11.9
VDB273221	13.1
VDB303221	14.5
VDB333221	15.8
VDB363221	17.2

**Custom Modifications**

AUTHL	CBO	CCO	CFNTO	CFP	CFRMO	CMAT	CND	DRWPWR	DRWTK	EXBKL	EXL	
•	•	•		•	•			•*	•+	•	•	
FB	FFDL	FPEB	FTK	FTKAV	FTKRV	ID	INVFRM	LTI	MIP	RD	RECTKALL	RECTKL
•		•	•	•▲					•	•	•	•
RT	TKP	TOTSS	TOTSSS	VTK	WLI							
				•								

\*Not available on 12" and 15" wide \*Not available on 12" and 15" wide, or on 18" deep

▲Not available on 12" wide

**Construction Upgrades**

APC	PE
•	•

**Door Options**

ALF	CG	DPSRR	MD	MFO

**VANITY DRAWER BASE,  
34 1/2" HIGH, 18" or 21" DEEP**

12", 15", 18", or 21"

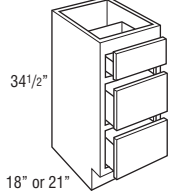

VDB123418 VDB123421  
VDB153418 VDB153421  
VDB183418 VDB183421  
VDB213418 VDB213421

18" or 21"

24", 27", 30", 33", or 36"

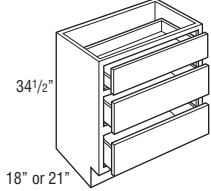

VDB243418 VDB243421  
VDB273418 VDB273421  
VDB303418 VDB303421  
VDB333418 VDB333421  
VDB363418 VDB363421

18" or 21"

Model	Cubic Feet	Model	Cubic Feet
VDB123418	5.8	VDB243418	10.9
VDB153418	7.1	VDB273418	12.2
VDB183418	8.3	VDB303418	13.5
VDB213418	9.6	VDB333418	14.7
VDB123421	7.8	VDB363418	16.0
VDB153421	9.4	VDB243421	14.4
VDB183421	11.1	VDB273421	11.4
VDB213421	12.8	VDB303421	12.6
		VDB333421	13.8
		VDB363421	15.0

**Custom Modifications**

AUTHL	CBO	CCO	CFNT0	CFP	CFRMO	CMAT	CND	DRWPWR	DRWTK	EXBKL	EXL
AUTHR										EXBKR	EXR
•	•	•		•	•			•*	•*	•	•
FB	FFDL	FPEB	FTK	FTKAV	ID	INVFRM	LTI	MIP	RD	RECTKALL	RECTKL
•	•	•	•	•▲	•			•	•	RECTKKB	RECTKR
RT	TKP	TOTSS	TOTSSS	VTK	WLI						
				•							

\*Not available on 12" and 15" wide \*Not available on 12" and 15" wide, or on 18" deep

▲Not available on 12" wide

**Construction Upgrades**

APC	PE
•	•

**Door Options**

ALF	CG	DPSRR	MD	MFO

**VANITY FOUR DRAWER BASE,  
34 1/2" HIGH, 18" or 21" DEEP**

12", 15", 18", or 21"

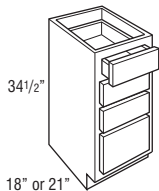

4VDB123418 4VDB123421  
4VDB153418 4VDB153421  
4VDB183418 4VDB183421  
4VDB213418 4VDB213421

18" or 21"

24", 27", 30", 33", or 36"

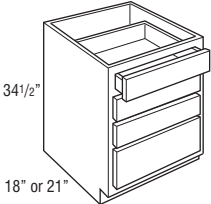

4VDB243418 4VDB243421  
4VDB273418 4VDB273421  
4VDB303418 4VDB303421  
4VDB333418 4VDB333421  
4VDB363418 4VDB363421

18" or 21"

Model	Cubic Feet	Model	Cubic Feet
4VDB123418	5.8	4VDB243418	10.9
4VDB153418	7.0	4VDB273418	12.2
4VDB183418	8.3	4VDB303418	13.5
4VDB213418	9.6	4VDB333418	14.7
4VDB123421	6.8	4VDB363418	16.0
4VDB153421	8.2	4VDB243421	12.7
4VDB183421	9.7	4VDB273421	13.9
4VDB213421	11.2	4VDB303421	15.3
		4VDB333421	16.8
		4VDB363421	18.2

**Custom Modifications**

AUTHL	CBO	CCO	CFNT0	CFP	CFRMO	CMAT	CND	DRWPWR	DRWTK	EXBKL	EXL
AUTHR										EXBKR	EXR
•	•	•		•	•			•*	•*	•	•
FB	FFDL	FPEB	FTK	FTKAV	ID	INVFRM	LTI	MIP	RD	RECTKALL	RECTKL
•	•	•	•	•▲	•			•	•	RECTKKB	RECTKR
RT	TKP	TOTSS	TOTSSS	VTK	WLI						
				•							

\*Not available on 12" and 15" wide \*Not available on 12" and 15" wide, or on 18" deep

▲Not available on 12" wide

**Construction Upgrades**

APC	PE
•	•

**Door Options**

ALF	CG	DPSRR	MD	MFO

**VANITY BASE WASTEBASKET,  
34 1/2" HIGH, 21" DEEP**

LOGIX

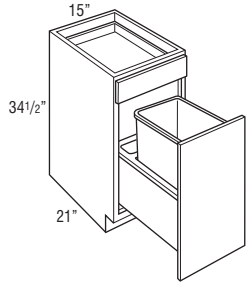

Model	Cubic Feet
<b>VBWB153421</b>	<b>9.4</b>

- Includes one 35 quart gray wastebasket and one trash bag storage area.
- Pull-out features undermount Smart Stop guides.

**Custom Modifications**

AUTHL AUTHR	CBO	CCO	CFNT0	CFP	CFRMO	CMAT	CND	DRWPWR	DRWTK	EXBKL EXBKR	EXL EXR
•	•	•		•	•		•	•		•	•
FB	FFDL FFDR	FPEB	FTK	FTKAV FTKRV	ID	INVFRM	LTI	MIP	RD	RECTKALL RECTKBK	RECTKL RECTKR
•		•	•	•				•		•	•
RT	TKP	TOTSS TOTSSS	VTK	WLI							
			•	•							

**Construction Upgrades**

APC	PE
•	•

**Door Options**

ALF	CG	DPSRR	MD	MFO

**VANITY WASTEBASKET FULL HEIGHT,  
32" HIGH, 21" DEEP**

LOGIX

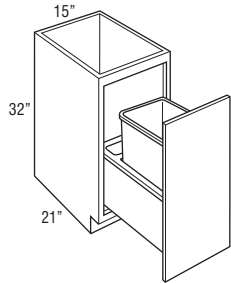

Model	Cubic Feet
<b>VWB153221</b>	<b>7.8</b>

- Includes one 35 quart gray wastebasket and one trash bag storage area.
- Pull-out features undermount Smart Stop guides.

**Custom Modifications**

AUTHL AUTHR	CBO	CCO	CFNT0	CFP	CFRMO	CMAT	CND	DRWPWR	DRWTK	EXBKL EXBKR	EXL EXR
•	•	•			•					•	•
FB	FFDL FFDR	FPEB	FTK	FTKAV FTKRV	ID	INVFRM	LTI	MIP	RD	RECTKALL RECTKBK	RECTKL RECTKR
•		•	•	•				•		•	•
RT	TKP	TOTSS TOTSSS	VTK	WLI							
			•	•							

**Construction Upgrades**

APC	PE
•	•

**Door Options**

ALF	CG	DPSRR	MD	MFO

**VANITY WASTEBASKET FULL HEIGHT  
with ROLL TRAY, 32" HIGH,  
21" DEEP**

LOGIX

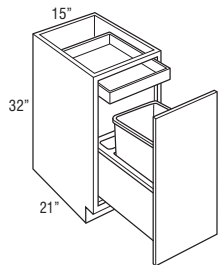

Model	Cubic Feet
<b>VWB153221RT</b>	<b>7.8</b>

- Includes one 35 quart gray wastebasket and one trash bag storage area.
- Pull-out features undermount Smart Stop guides.
- 1 roll tray standard.
- Not compatible with BWBLUD due to limited height clearance.

**Custom Modifications**

AUTHL AUTHR	CBO	CCO	CFNT0	CFP	CFRMO	CMAT	CND	DRWPWR	DRWTK	EXBKL EXBKR	EXL EXR
•	•	•			•					•	•
FB	FFDL FFDR	FPEB	FTK	FTKAV FTKRV	ID	INVFRM	LTI	MIP	RD	RECTKALL RECTKBK	RECTKL RECTKR
•		•	•	•				•		•	•
RT	TKP	TOTSS TOTSSS	VTK	WLI							
			•	•							

**Construction Upgrades**

APC	PE
•	•

**Door Options**

ALF	CG	DPSRR	MD	MFO



**VANITY WASTEBASKET FULL HEIGHT,  
34 1/2" HIGH, 21" DEEP**

L O G I X

Model	Cubic Feet
VWB153421	9.4

- Includes one 35 quart gray wastebasket and one trash bag storage area.
- Pull-out features undermount Smart Stop guides.

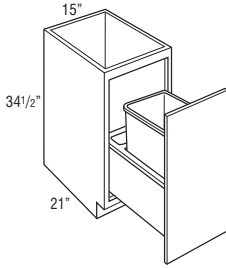

**Custom Modifications**

AUTHL AUTHR	CBO	CCO	CFNT0	CFP	CFRMO	CMAT	CND	DRWPWR	DRWTK	EXBKL EXBKR	EXL EXR
•	•	•			•					•	•
FB	FFDL FFDR	FPEB	FTK	FTKAV FTKRV	ID	INVFRM	LTI	MIP	RD	RECTKALL RECTKBK	RECTKL RECTKR
•		•	•	•				•		•	•
RT	TKP	TOTSS TOTSSS	VTK	WLI							
			•	•							

**Construction Upgrades**

APC	PE
•	•

**Door Options**

ALF	CG	DPSRR	MD	MFO

**VANITY WASTEBASKET FULL HEIGHT  
with ROLL TRAY, 34 1/2" HIGH,  
21" DEEP**

L O G I X

Model	Cubic Feet
VWB153421RT	9.4

- Includes one 35 quart gray wastebasket and one trash bag storage area.
- Pull-out features undermount Smart Stop guides.
- 1 roll tray standard.

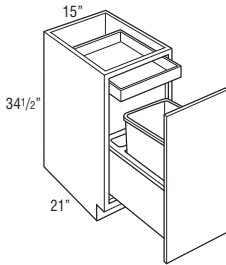

**Custom Modifications**

AUTHL AUTHR	CBO	CCO	CFNT0	CFP	CFRMO	CMAT	CND	DRWPWR	DRWTK	EXBKL EXBKR	EXL EXR
•	•	•			•					•	•
FB	FFDL FFDR	FPEB	FTK	FTKAV FTKRV	ID	INVFRM	LTI	MIP	RD	RECTKALL RECTKBK	RECTKL RECTKR
•		•	•	•				•		•	•
RT	TKP	TOTSS TOTSSS	VTK	WLI							
			•	•							

**Construction Upgrades**

APC	PE
•	•

**Door Options**

ALF	CG	DPSRR	MD	MFO

**VANITY PULL-OUT,  
34 1/2" HIGH, 21" DEEP**

L O G I X

Model	Cubic Feet
VP93421	4.9

- All styles feature a natural finish full extension wood pull-out with adjustable shelves and chrome rail sides (Smart Stop not included).

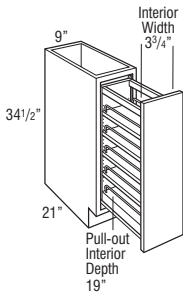

**Custom Modifications**

AUTHL AUTHR	CBO	CCO	CFNT0	CFP	CFRMO	CMAT	CND	DRWPWR	DRWTK	EXBKL EXBKR	EXL EXR
•	•	•			•					•	•
FB	FFDL FFDR	FPEB	FTK	FTKAV FTKRV	ID	INVFRM	LTI	MIP	RD	RECTKALL RECTKBK	RECTKL RECTKR
•		•	•					•		•*	•
RT	TKP	TOTSS TOTSSS	VTK	WLI							
			•	•							

\*RECTKALL not available

**Construction Upgrades**

APC	PE
•	•

**Door Options**

ALF	CG	DPSRR	MD	MFO
		•		

**VANITY GROOMING PULL-OUT,  
34 1/2" HIGH, 21" DEEP**

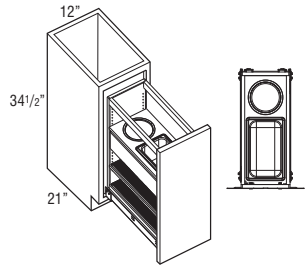

LOGIX

Model	Cubic Feet
<b>VGPO123421</b>	<b>6.8</b>

- Full extension, Smart Stop wood pull-out with natural finish.
- Pull-out is 19" deep.
- Features adjustable shelves with non-skid vinyl liners and clear polycarbonate rails.
- Includes two stainless steel bins (one rectangular and one round) for storing items such as curling irons and hair dryers.

**Custom Modifications**

AUTHL AUTHR	CBO	CCO	CFNTO	CFP	CFRMO	CMAT	CND	DRWPWR	DRWTK	EXBKL EXBKR	EXL EXR
•	•	•			•					•	•
FB	FFDL FFDR	FPEB	FTK	FTKAV FTKRV	ID	INVERM	LTI	MIP	RD	RECTKALL RECTKBK	RECTKL RECTKR
•		•	•					•		•	•
RT	TKP	TOTSS TOTSSS	VTK	WLI							
			•	•							

**Construction Upgrades**

APC	PE
•	•

**Door Options**

ALF	CG	DPSRR	MD	MFO
		•		

**VANITY SINK DRAWER BASE,  
32" HIGH, 18" or 21" DEEP**

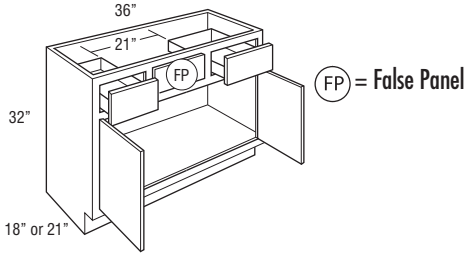

2VSD363218  
2VSD363221

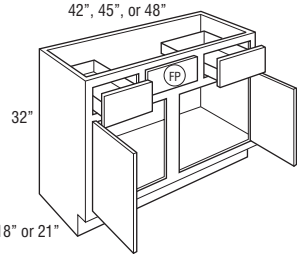

2VSD423218    2VSD423221  
2VSD453218    2VSD453221  
2VSD483218CS    2VSD483221CS

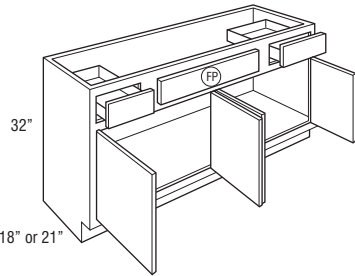

2VSD483218  
2VSD483221

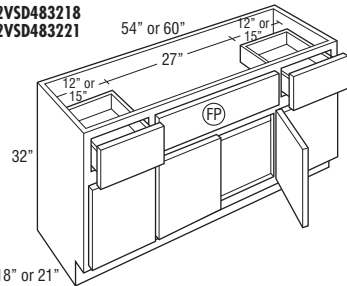

2VSD543218FP    2VSD543221FP  
2VSD603218FP    2VSD603221FP

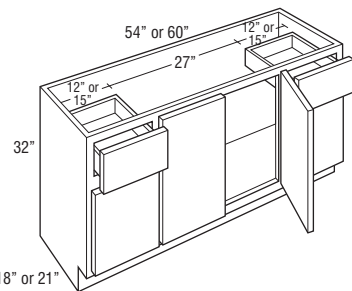

2VSD543218    2VSD543221  
2VSD603218    2VSD603221

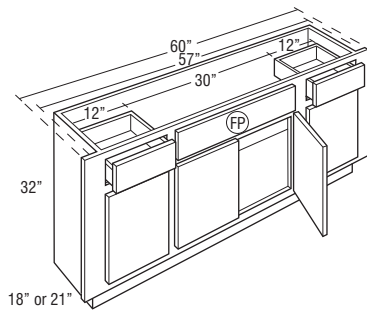

2VSD57/603218FP  
2VSD57/603221FP

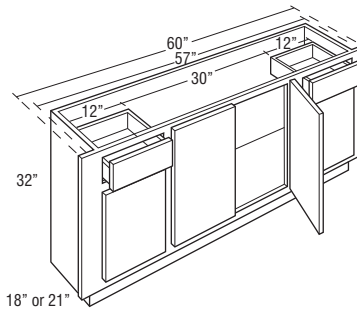

2VSD57/603218  
2VSD57/603221

Model	Cubic Feet	Model	Cubic Feet
2VSD363218	15.1	2VSD543218	23.2
2VSD363221	17.4	2VSD603218	24.4
2VSD423218	17.5	2VSD543221	25.2
2VSD453218	18.5	2VSD603221	28.0
2VSD483218CS	19.9	2VSD57/603218FP	25.6
2VSD423221	20.1	2VSD57/603221FP	27.6
2VSD453221	21.3	2VSD57/603218	25.6
2VSD483221CS	22.9	2VSD57/603221	27.6
2VSD483218	19.9		
2VSD483221	22.9		
2VSD543218FP	23.2		
2VSD603218FP	24.4		
2VSD543221FP	25.2		
2VSD603221FP	28.0		

- 2VSD36/2VSD42/2VSD48 cabinets have 21" wide space between drawers for sink.
- 2VSD45 cabinets have 24" wide space between drawers for sink.
- 2VSD54/2VSD60 cabinets have 27" wide space between drawers for sink.
- 2VSD57 cabinets have 30" wide space between drawers for sink.
- 2VSD57/603221 may be trimmed 1 1/2" per side.

**Custom Modifications**

AUTHL	AUTHR	CBO	CCO	CFNT0	CFP	CFRMO	CMAT	CND	DRWPWR	DRWTK	EXBKL	EXBKR	EXL	EXR
•*	•	•	•	•	•	•	•*	•	•▲	•†	•*	•	•	•
FB	FFDL	FFDR	FPEB	FTK	FTKAV	FTKRV	ID	INVRM	LTI	MIP	RD	RECTKALL	RECTKLBK	RECTKLR
•	•*	•*	•	•	•	•	•	•	•	•	•	•	•	•
RT	TKP	TOTSS	TOTSSS	VTK	WLI									
•‡	•	•^	•	•	•									

\*Not available on 2VSD57/60 and 2VSD57/60FP

†Available only on 2VSD363221    ‡Available only on 36", 42", 45", and 48" wide

▲Available only on 60" wide

^Available only on cabinets with false panels

**Construction Upgrades**

APC	PE
•	•

**Door Options**

ALF	CG	DPSRR	MD	MFO
		•		

**VANITY SINK DRAWER BASE,  
34 1/2" HIGH, 18" or 21" DEEP**

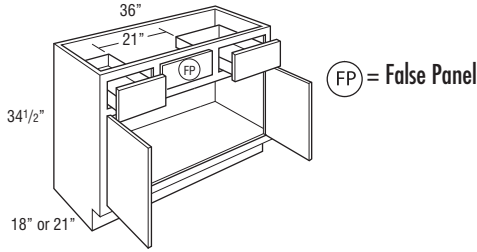

2VSD363418  
2VSD363421

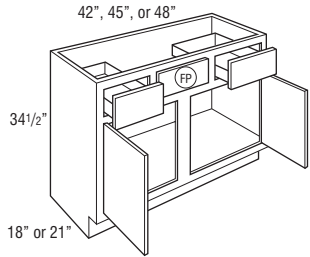

2VSD423418 2VSD423421  
2VSD453418 2VSD453421  
2VSD483418CS 2VSD483421CS

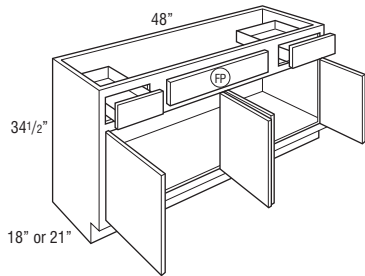

2VSD483418  
2VSD483421

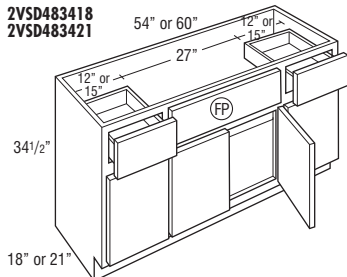

2VSD543418FP 2VSD543421FP  
2VSD603418FP 2VSD603421FP

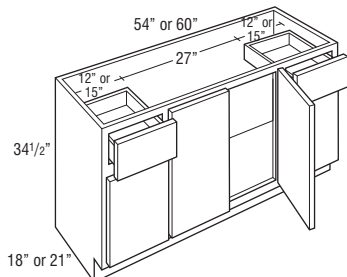

2VSD543418 2VSD543421  
2VSD603418 2VSD603421

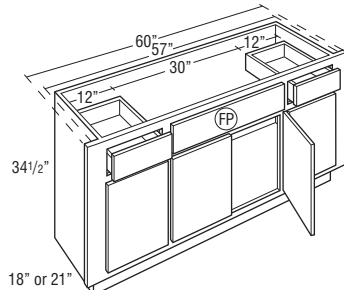

2VSD57/603418FP  
2VSD57/603421FP

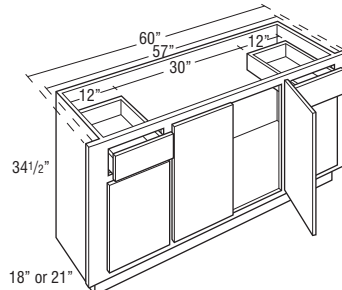

2VSD57/603418  
2VSD57/603421

Model	Cubic Feet	Model	Cubic Feet
2VSD363418	16.0	2VSD543418FP	23.7
2VSD363421	16.5	2VSD603418FP	26.3
		2VSD543421FP	24.5
		2VSD603421FP	30.1
2VSD423418	18.6		
2VSD453418	19.9	2VSD543418	23.7
2VSD483418CS	21.1	2VSD603418	26.3
2VSD423421	19.2	2VSD543421	24.5
2VSD453421	22.8	2VSD603421	30.1
2VSD483421CS	21.9		
		2VSD57/603418FP	25.0
2VSD483418	21.1	2VSD57/603421FP	27.2
2VSD483421	21.9		
		2VSD57/603418	25.0
		2VSD57/603421	27.2

- 2VSD36/2VSD42/2VSD48 cabinets have 21" wide space between drawers for sink.
- 2VSD45 cabinets have 24" wide space between drawers for sink.
- 2VSD54/2VSD60 cabinets have 27" wide space between drawers for sink.
- 2VSD57 cabinets have 30" wide space between drawers for sink.
- 2VSD57/603421 may be trimmed 1 1/2" per side.

**Custom Modifications**

AUTHL	AUTHR	CBO	CCO	CFNTO	CFP	CFRMO	CMAT	CND	DRWPWR	DRWTK	EXBKL	EXBKR	EXL	EXR
•*	•	•	•	•	•	•	•*	•	•^	•†	•*	•	•	•
FB	FFDL	FFDR	FPEB	FTK	FTKAV	FTKRV	ID	INVERM	LTI	MIP	RD	RECTKALL	RECTKBK	RECTKLR
•	•*	•*	•	•	•	•	•	•	•	•	•	•	•	•
RT	TKP	TOTSS	TOTSSS	VTK	WLI									
•‡	•	•^	•	•	•									

- \*Not available on 2VSD57/60 and 2VSD57/60FP
- †Available only on 2VSD363421
- ‡Available only on 36", 42", 45", and 48" wide
- ^Available only on 60" wide
- Available only on 18" deep
- Available only on cabinets with false panels

**Construction Upgrades**

APC	PE
•	•

**Door Options**

ALF	CG	DPSRR	MD	MFO
		•		

**VANITY SINK DRAWER BASE,  
32" HIGH, 18" or 21" DEEP**

24", 27", 30", or 33"

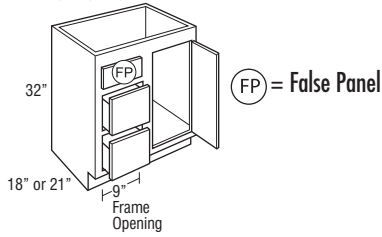

VSD243218 DL or DR    VSD243221 DL or DR  
VSD273218 DL or DR    VSD273221 DL or DR  
VSD303218 DL or DR    VSD303221 DL or DR  
VSD333218 DL or DR    VSD333221 DL or DR

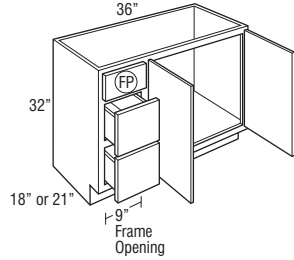

VSD363218 DL or DR  
VSD363221 DL or DR

42", 45", or 48"

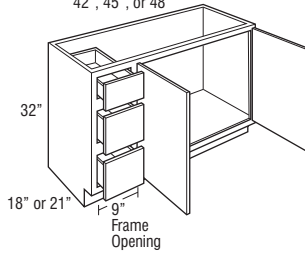

VSD423218 DL or DR    VSD423221 DL or DR  
VSD453218 DL or DR    VSD453221 DL or DR  
VSD483218 DL or DR    VSD483221 DL or DR

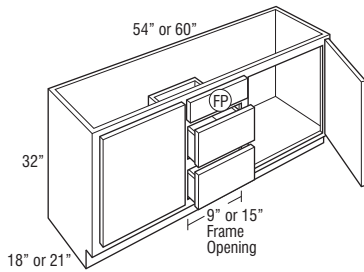

VSD543218    VSD543221  
VSD603218    VSD603221

Model	Cubic Feet
VSD243218 DL or DR	10.4
VSD273218 DL or DR	11.7
VSD303218 DL or DR	12.7
VSD333218 DL or DR	14.1
VSD243221 DL or DR	11.9
VSD273221 DL or DR	13.3
VSD303221 DL or DR	14.6
VSD333221 DL or DR	16.1
VSD363218 DL or DR	15.1
VSD363221 DL or DR	17.4
VSD423218 DL or DR	17.5
VSD453218 DL or DR	18.5
VSD483218 DL or DR	19.9
VSD423221 DL or DR	20.1
VSD453221 DL or DR	18.5
VSD483221 DL or DR	22.9
VSD543218	22.1
VSD603218	24.7
VSD543221	25.3
VSD603221	28.4

- DL or DR indicates drawer location.
- CFP is available on 42", 45", and 48" widths, but standard on all other widths.

**Custom Modifications**

AUTHL AUTHR	CBO	CCO	CFNTO	CFP	CFRMO	CMAT	CND	DRWPWR	DRWTK	EXBKL EXBKR	EXL EXR
•	•	•		STD	•	•*	•		•*	•	•
FB	FFDL FFDR	FPEB	FTK	FTKAV FTKFV	ID	INVFRM	LTI	MIP	RD	RECTKLL RECTKKB	RECTKL RECTKR
•	•	•	•	•	•		•▲	•	•	•	•
RT	TKP	TOTSS TOTSSS	VTK	WLI							
			•	•							

\*Not available on 24", 27", 30", 33", and 60" wide, or on 18" deep

\*Not available on 42", 45", 48", 54" and 60" wide, or on 18" deep ▲Not available on 24" wide

**Construction Upgrades**

APC	PE
•	•

**Door Options**

ALF	CG	DPSRR	MD	MFO
		•		

**VANITY SINK DRAWER BASE,  
34 1/2" HIGH, 18" or 21" DEEP**

24", 27", 30", or 33"

(FP) = False Panel

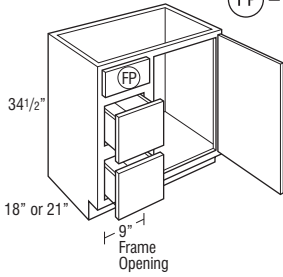

VSD243418 DL or DR VSD243421 DL or DR  
VSD273418 DL or DR VSD273421 DL or DR  
VSD303418 DL or DR VSD303421 DL or DR  
VSD333418 DL or DR VSD333421 DL or DR

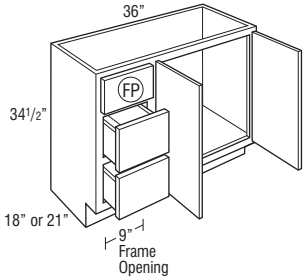

VSD363418 DL or DR  
VSD363421 DL or DR

42", 45", or 48"

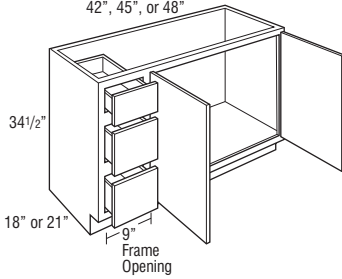

VSD423418 DL or DR VSD423421 DL or DR  
VSD453418 DL or DR VSD453421 DL or DR  
VSD483418 DL or DR VSD483421 DL or DR

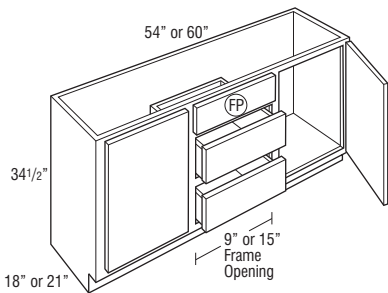

VSD543418 VSD543421  
VSD603418 VSD603421

Model	Cubic Feet
VSD243418 DL or DR	10.9
VSD273418 DL or DR	12.2
VSD303418 DL or DR	13.5
VSD333418 DL or DR	14.7
VSD243421 DL or DR	11.1
VSD273421 DL or DR	14.1
VSD303421 DL or DR	13.8
VSD333421 DL or DR	17.1
VSD363418 DL or DR	16.0
VSD363421 DL or DR	16.5
VSD423418 DL or DR	18.6
VSD453418 DL or DR	19.9
VSD483418 DL or DR	21.1
VSD423421 DL or DR	19.2
VSD453421 DL or DR	21.3
VSD483421 DL or DR	21.9
VSD543418	23.7
VSD603418	26.3
VSD543421	27.2
VSD603421	27.2

- DL or DR indicates drawer location.
- CFP is available on 42", 45", and 48" widths, but standard on all other widths.

**Custom Modifications**

AUTHL	AUTHR	CBO	CCO	CFNTO	CFP	CFRMO	CMAT	CND	DRWPWR	DRWTK	EXBKL	EXBKR	EXL	EXR	
•	•	•	•	•	STD	•	•*	•	•	•+	•	•	•	•	
FB	FFDL	FFDR	FPEB	FTK	FTKAV	FTKVV	ID	INVFRM	LTI	MIP	RD	RECTKLL	RECTKLBK	RECTKL	RECTKR
•	•	•	•	•	•	•	•	•	•*	•	•	•	•	•	
RT	TKP	TOTSS	TOTSSS	VTK	WLI										
				•	•										

\*Not available on 24", 27", 30", 33", and 60" wide, or on 18" deep

\*Not available on 42", 45", 48", 54" and 60" wide, or on 18" deep    +Not available on 24" wide

**Construction Upgrades**

APC	PE
•	•

**Door Options**

ALF	CG	DPSRR	MD	MFO
		•		

**VANITY SINK DRAWER BASE with FALSE PANELS, 32" HIGH, 18" or 21" DEEP**

24", 27", 30", or 33"

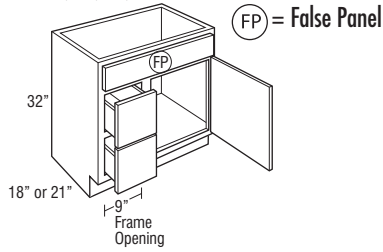

- VSD243218FP DL or DR    VSD243221FP DL or DR
- VSD273218FP DL or DR    VSD273221FP DL or DR
- VSD303218FP DL or DR    VSD303221FP DL or DR
- VSD333218FP DL or DR    VSD333221FP DL or DR

36"

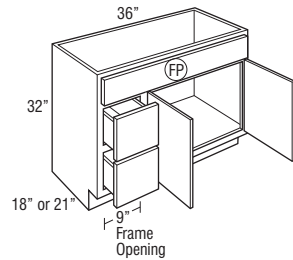

- VSD363218FP DL or DR
- VSD363221FP DL or DR

42", 45", or 48"

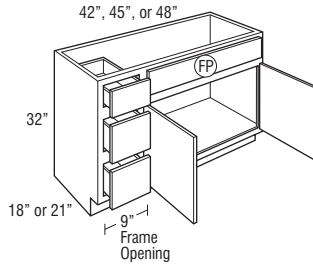

- VSD423218FP DL or DR    VSD423221FP DL or DR
- VSD453218FP DL or DR    VSD453221FP DL or DR
- VSD483218FP DL or DR    VSD483221FP DL or DR

54" or 60"

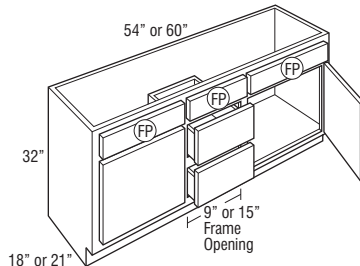

- VSD543218FP    VSD543221FP
- VSD603218FP    VSD603221FP

Model	Cubic Feet
VSD243218FP DL or DR	10.4
VSD273218FP DL or DR	11.7
VSD303218FP DL or DR	12.7
VSD333218FP DL or DR	14.1
VSD243221FP DL or DR	11.9
VSD273221FP DL or DR	13.3
VSD303221FP DL or DR	14.6
VSD333221FP DL or DR	16.1
VSD363218FP DL or DR	15.1
VSD363221FP DL or DR	17.4
VSD423218FP DL or DR	17.5
VSD453218FP DL or DR	18.5
VSD483218FP DL or DR	19.9
VSD423221FP DL or DR	20.1
VSD453221FP DL or DR	21.3
VSD483221FP DL or DR	22.9
VSD543218FP	22.1
VSD603218FP	24.7
VSD543221FP	25.3
VSD603221FP	28.4

- DL or DR indicates drawer location.
- CFP is available on 42", 45", and 48" widths, but standard on all other widths.

**Custom Modifications**

AUTHL	CBO	CCO	CFNT0	CFP	CFRMO	CMAT	CND	DRWPWR	DRWTK	EXBKL	EXL
•	•	•		STD	•	•*	•		•*	•	•
FB	FFDL	FPEB	FTK	FTKAV	ID	INVFRM	LTI	MIP	RD	RECTKLL	RECTKL
•	•	•	•	•	•		•▲	•	•	•	•
RT	TKP	TOTSS	VTK	WLI							
		•	•	•							

- \*Not available on 24", 27", 30", 33", and 60" wide, or on 18" deep
- \*Not available on 42", 45", 48", 54" and 60" wide, or on 18" deep    ▲Not available on 24" wide

**Construction Upgrades**

APC	PE
•	•

**Door Options**

ALF	CG	DPSRR	MD	MFO
		•		

**VANITY SINK DRAWER BASE with FALSE PANEL, 34 1/2" HIGH, 18" or 21" DEEP**

24", 27", 30", or 33"

(FP) = False Panel

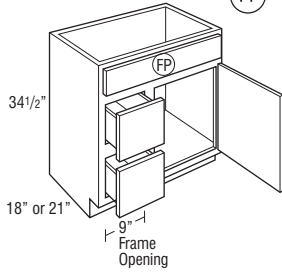

- VSD243418FP DL or DR    VSD243421FP DL or DR
- VSD273418FP DL or DR    VSD273421FP DL or DR
- VSD303418FP DL or DR    VSD303421FP DL or DR
- VSD333418FP DL or DR    VSD333421FP DL or DR

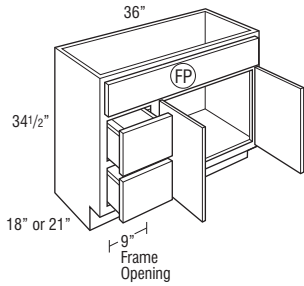

- VSD363418FP DL or DR
- VSD363421FP DL or DR

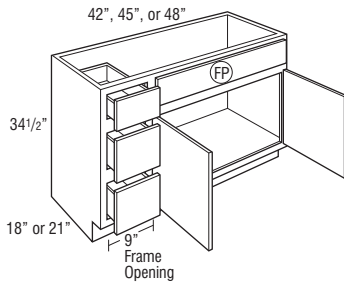

- VSD423418FP DL or DR    VSD423421FP DL or DR
- VSD453418FP DL or DR    VSD453421FP DL or DR
- VSD483418FP DL or DR    VSD483421FP DL or DR

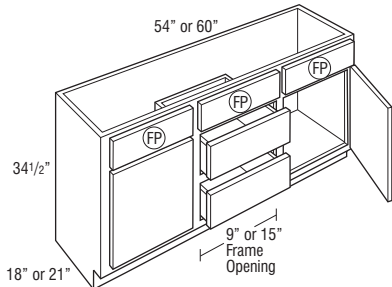

- VSD543418FP    VSD543421FP
- VSD603418FP    VSD603421FP

Model	Cubic Feet
VSD243418FP DL or DR	10.9
VSD273418FP DL or DR	12.2
VSD303418FP DL or DR	13.5
VSD333418FP DL or DR	14.7
VSD243421FP DL or DR	11.1
VSD273421FP DL or DR	14.1
VSD303421FP DL or DR	13.8
VSD333421FP DL or DR	17.1
VSD363418FP DL or DR	16.0
VSD363421FP DL or DR	16.5
VSD423418FP DL or DR	18.6
VSD453418FP DL or DR	19.9
VSD483418FP DL or DR	21.1
VSD423421FP DL or DR	22.8
VSD453421FP DL or DR	22.8
VSD483421FP DL or DR	21.9
<b>VSD543418FP</b>	22.1
<b>VSD603418FP</b>	26.3
<b>VSD543421FP</b>	25.3
<b>VSD603421FP</b>	27.2

- DL or DR indicates drawer location.
- CFP is available on 42", 45", and 48" widths, but standard on all other widths.

**Custom Modifications**

AUTHL	CBO	CCO	CFNTO	CFP	CFRMO	CMAT	CND	DRWPWR	DRWTK	EXBKL	EXL
•	•	•		STD	•	•*	•		•+	•	•
FB	FFDL FFDR	FPEB	FTK	FTKAV FTKFV	ID	INVERM	LTI	MIP	RD	RECTKALL RECTKBK	RECTKL RECTKR
•	•	•	•	•	•		•*	•	•	•	•
RT	TKP	TOTSS TOTSSS	VTK	WLI							
		•	•	•							

\*Not available on 24", 27", 30", 33", and 60" wide, or on 18" deep

\*Not available on 42", 45", 48", 54" and 60" wide, or on 18" deep    +Not available on 24" wide

**Construction Upgrades**

APC	PE
•	•

**Door Options**

ALF	CG	DPSRR	MD	MFO
		•		



**VANITY SINK THREE DRAWER BASE,  
32" HIGH, 18" or 21" DEEP**

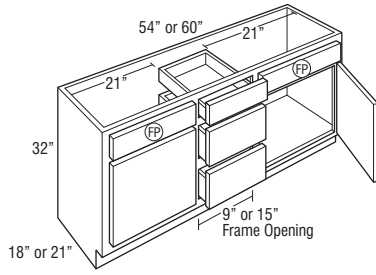

Model	Cubic Feet
<b>VS3D543218</b>	22.1
<b>VS3D603218</b>	24.4
<b>VS3D543221</b>	25.3
<b>VS3D603221</b>	28.0

**Custom Modifications**

AUTHL	AUTHR	CBO	CCO	CFNT0	CFP	CFRMO	CMAT	CND	DRWPWR	DRWTK	EXBKL	EXL	EXBKR	EXR
•	•	•	•	•	•	•	•*	•	•*	•	•	•	•	•
FB	FFDL	FFDR	FPEB	FTK	FTKAV	FTKFV	ID	INVFRM	LTI	MIP	RD	RECTKL	RECTKBK	RECTKR
•	•	•	•	•	•	•	•	•	•	•	•	•	•	•
RT	TKP	TOTSS	TOTSSS	VTK	WLI									
		•	•	•	•									

\*Not available on 18" deep \*Available only on 60" wide

**Construction Upgrades**

APC	PE
•	•

**Door Options**

ALF	CG	DPSRR	MD	MFO
		•		

**VANITY SINK THREE DRAWER BASE,  
34 1/2" HIGH, 18" or 21" DEEP**

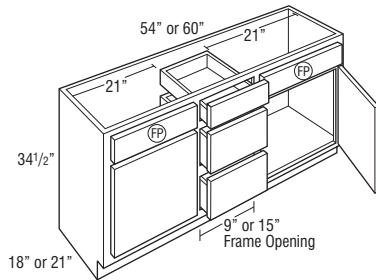

<b>VS3D543418</b>	23.7
<b>VS3D603418</b>	26.3
<b>VS3D543421</b>	27.2
<b>VS3D603421</b>	30.1

**Custom Modifications**

AUTHL	AUTHR	CBO	CCO	CFNT0	CFP	CFRMO	CMAT	CND	DRWPWR	DRWTK	EXBKL	EXL	EXBKR	EXR
•	•	•	•	•	•	•	•*	•	•*	•	•	•	•	•
FB	FFDL	FFDR	FPEB	FTK	FTKAV	FTKFV	ID	INVFRM	LTI	MIP	RD	RECTKL	RECTKBK	RECTKR
•	•	•	•	•	•	•	•	•	•	•	•	•	•	•
RT	TKP	TOTSS	TOTSSS	VTK	WLI									
		•	•	•	•									

\*Not available on 18" deep \*Available only on 60" wide

**Construction Upgrades**

APC	PE
•	•

**Door Options**

ALF	CG	DPSRR	MD	MFO
		•		

**VANITY SINK DRAWER BASE with SIX DRAWERS, 32" HIGH, 18" or 21" DEEP**

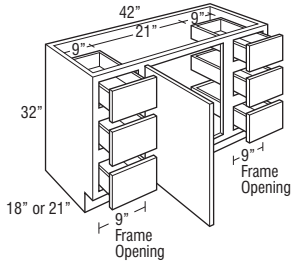

6VSD423218 L or R  
6VSD423221 L or R

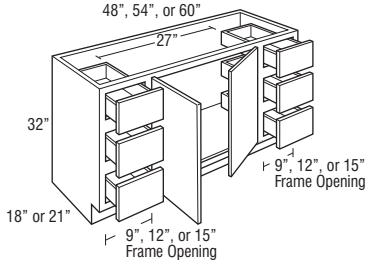

6VSD483218 6VSD543218 6VSD603218  
6VSD483221 6VSD543221 6VSD603221

Model	Cubic Feet
6VSD423218 L or R	17.3
6VSD423221 L or R	19.8
6VSD483218	19.9
6VSD483221	22.9
6VSD543218	22.1
6VSD543221	25.3
6VSD603218	24.7
6VSD603221	28.4

- 6VSD42 and 6VSD48 drawer stacks are 12" wide.
- 6VSD54 drawer stacks are 15" wide.
- 6VSD60 drawer stacks are 18" wide.
- 42" wide cabinets have a sink opening of only 21" instead of standard 27".

**Custom Modifications**

AUTHL	CBO	CCO	CFNT0	CFP	CFRMO	CMAT	CND	DRWPWR	DRWTK	EXBKL	EXL
AUTHR										EXBKR	EXR
•	•	•		•	•	•*	•	•*		•	•
FB	FFDL	FPEB	FTK	FTKAV	ID	INVFRM	LTI	MIP	RD	RECTKALL	RECTKL
	FFDR			FTKRV						RECTKBK	RECTKR
•	•	•	•	•	•		•	•	•	•	•
RT	TKP	TOTSS	VTK	WLI							
		TOTSSS									
			•	•							

\*Not available on 42" wide, or on 18" deep \*Available only on 60" wide

**Construction Upgrades**

APC	PE
•	•

**Door Options**

ALF	CG	DPSRR	MD	MFO
		•		

**VANITY SINK DRAWER BASE with SIX DRAWERS, 34 1/2" HIGH, 18" or 21" DEEP**

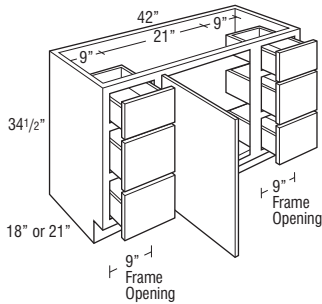

6VSD423418 L or R  
6VSD423421 L or R

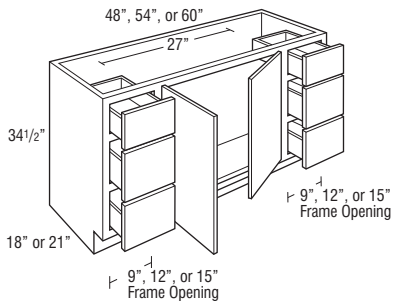

6VSD483418 6VSD543418 6VSD603418  
6VSD483421 6VSD543421 6VSD603421

6VSD423418 L or R	18.6
6VSD423421 L or R	21.3
6VSD483418	21.1
6VSD483421	21.9
6VSD543418	23.7
6VSD543421	27.2
6VSD603418	26.3
6VSD603421	27.2

- 6VSD42 and 6VSD48 drawer stacks are 12" wide.
- 6VSD54 drawer stacks are 15" wide.
- 6VSD60 drawer stacks are 18" wide.
- 42" wide cabinets have a sink opening of only 21" instead of standard 27".

**Custom Modifications**

AUTHL	CBO	CCO	CFNT0	CFP	CFRMO	CMAT	CND	DRWPWR	DRWTK	EXBKL	EXL
AUTHR										EXBKR	EXR
•	•	•		•	•	•*	•	•*		•	•
FB	FFDL	FPEB	FTK	FTKAV	ID	INVFRM	LTI	MIP	RD	RECTKALL	RECTKL
	FFDR			FTKRV						RECTKBK	RECTKR
•	•	•	•	•	•		•	•	•	•	•
RT	TKP	TOTSS	VTK	WLI							
		TOTSSS									
			•	•							

\*Not available on 42" wide, or on 18" deep \*Available only on 60" wide

**Construction Upgrades**

APC	PE
•	•

**Door Options**

ALF	CG	DPSRR	MD	MFO
		•		

**VANITY SINK DRAWER BASE with SIX DRAWERS & FALSE PANEL, 32" HIGH, 18" or 21" DEEP**

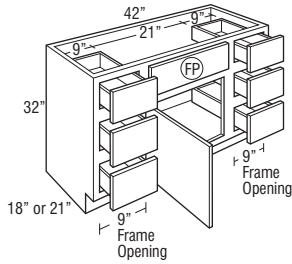

6VSD423218FP L or R  
6VSD423221FP L or R

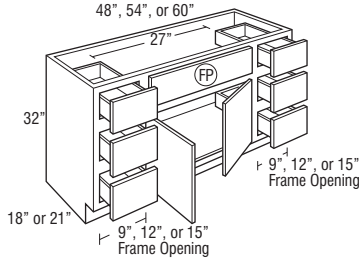

6VSD483218FP 6VSD543218FP 6VSD603218FP  
6VSD483221FP 6VSD543221FP 6VSD603221FP

Model	Cubic Feet
6VSD423218FP L or R	17.3
6VSD423221FP L or R	19.8
6VSD483218FP	19.9
6VSD483221FP	22.9
6VSD543218FP	22.1
6VSD543221FP	25.3
6VSD603218FP	24.7
6VSD603221FP	28.4

- 6VSD42 and 6VSD48 drawer stacks are 12" wide.
- 6VSD54 drawer stacks are 15" wide.
- 6VSD60 drawer stacks are 18" wide.
- 42" wide cabinets have a sink opening of only 21" instead of standard 27".

**Custom Modifications**

AUTHL AUTHR	CBO	CCO	CFNT0	CFP	CFRMO	CMAT	CND	DRWPWR	DRWTK	EXBKL EXBKR	EXL EXR
•	•	•		•	•	•*	•	•*		•	•
FB	FFDL FFDR	FPEB	FTK	FTKAV FTKFV	ID	INVFRM	LTI	MIP	RD	RECTKALL RECTKBK	RECTKL RECTKR
•		•	•	•			•	•	•	•	•
RT	TKP	TOTSS TOTSSS	VTK	WLI							
		•	•	•							

\*Not available on 42" wide, or on 18" deep \*Available only on 60" wide

**Construction Upgrades**

APC	PE
•	•

**Door Options**

ALF	CG	DPSRR	MD	MFO
		•		

**VANITY SINK DRAWER BASE with SIX DRAWERS & FALSE PANEL, 34 1/2" HIGH, 18" or 21" DEEP**

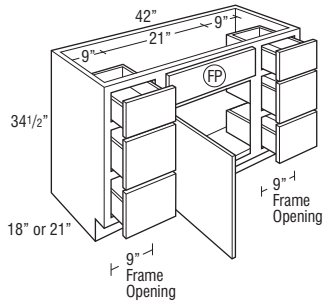

6VSD423418FP L or R  
6VSD423421FP L or R

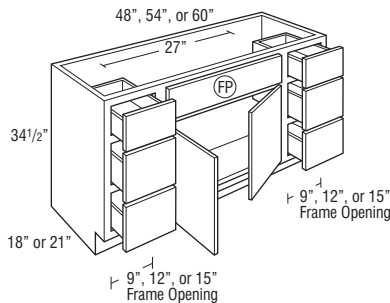

6VSD483418FP 6VSD543418FP 6VSD603418FP  
6VSD483421FP 6VSD543421FP 6VSD603421FP

6VSD423418FP L or R	18.6
6VSD423421FP L or R	21.3
6VSD483418FP	21.1
6VSD483421FP	21.9
6VSD543418FP	23.7
6VSD543421FP	27.2
6VSD603418FP	26.3
6VSD603421FP	27.2

- 6VSD42 and 6VSD48 drawer stacks are 12" wide.
- 6VSD54 drawer stacks are 15" wide.
- 6VSD60 drawer stacks are 18" wide.
- 42" wide cabinets have a sink opening of only 21" instead of standard 27".

**Custom Modifications**

AUTHL AUTHR	CBO	CCO	CFNT0	CFP	CFRMO	CMAT	CND	DRWPWR	DRWTK	EXBKL EXBKR	EXL EXR
•	•	•		•	•	•*	•	•*		•	•
FB	FFDL FFDR	FPEB	FTK	FTKAV FTKFV	ID	INVFRM	LTI	MIP	RD	RECTKALL RECTKBK	RECTKL RECTKR
•		•	•	•			•	•	•	•	•
RT	TKP	TOTSS TOTSSS	VTK	WLI							
		•	•	•							

\*Not available on 42" wide, or on 18" deep \*Available only on 60" wide

**Construction Upgrades**

APC	PE
•	•

**Door Options**

ALF	CG	DPSRR	MD	MFO
		•		

**VANITY SINK DRAWER BASE with EIGHT DRAWERS, 34 1/2" HIGH, 18" or 21" DEEP**

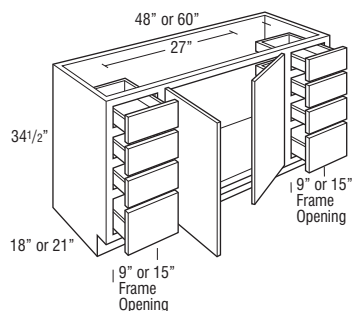

Model	Cubic Feet
<b>8VSD483418</b>	21.1
<b>8VSD603418</b>	26.3
<b>8VSD483421</b>	21.9
<b>8VSD603421</b>	27.2

- 8VSD48 drawer stacks are 12" wide.
- 8VSD60 drawer stacks are 18" wide.
- All have 27" wide space between drawers for sink.

**Custom Modifications**

AUTHL	CBO	CCO	CFNTO	CFP	CFRMO	CMAT	CND	DRWPWR	DRWTK	EXBKL	EXL
AUTHR	•	•		•	•	•*	•	•*		•	•
FB	FFDL FFDR	FPEB	FTK	FTKAV FTKRV	ID	INVFRM	LTI	MIP	RD	RECTKALL RECTKBK	RECTKL RECTKR
•	•	•	•	•	•		•	•	•	•	•
RT	TKP	TOTSS TOTSSS	VTK	WLI							
		•	•	•							

\*Not available on 18" deep      \*Available only on 60" wide

**Construction Upgrades**

APC	PE
•	•

**Door Options**

ALF	CG	DPSRR	MD	MFO
		•		

**VANITY SINK DRAWER BASE with EIGHT DRAWERS & FALSE PANEL, 34 1/2" HIGH, 18 or 21" DEEP**

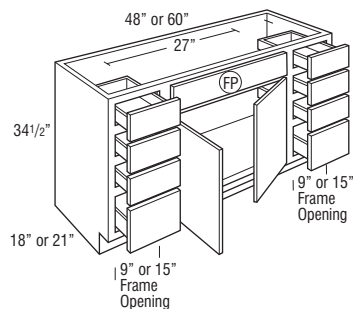

<b>8VSD483418FP</b>	21.1
<b>8VSD603418FP</b>	26.3
<b>8VSD483421FP</b>	21.9
<b>8VSD603421FP</b>	27.2

- 8VSD48 drawer stacks are 12" wide.
- 8VSD60 drawer stacks are 18" wide.
- All have 27" wide space between drawers for sink.

**Custom Modifications**

AUTHL	CBO	CCO	CFNTO	CFP	CFRMO	CMAT	CND	DRWPWR	DRWTK	EXBKL	EXL
AUTHR	•	•		•	•	•*	•	•*		•	•
FB	FFDL FFDR	FPEB	FTK	FTKAV FTKRV	ID	INVFRM	LTI	MIP	RD	RECTKALL RECTKBK	RECTKL RECTKR
•	•	•	•	•	•		•	•	•	•	•
RT	TKP	TOTSS TOTSSS	VTK	WLI							
		•	•	•							

\*Not available on 18" deep      \*Available only on 60" wide

**Construction Upgrades**

APC	PE
•	•

**Door Options**

ALF	CG	DPSRR	MD	MFO
		•		

**VANITY ANGLE CORNER SINK FRONT,  
32" HIGH**

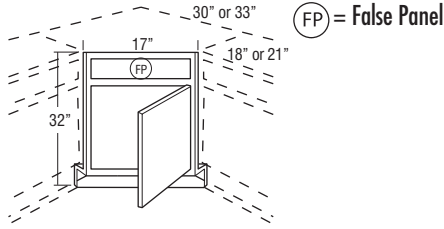

Model	Cubic Feet
VACSF L or R	3.3

- Edges are angled at 45°.
- Requires sink bottom for field installation. Order separately.
- Toekick and toekick retainer shipped unattached from the face frame.
- Full overlay styles use the same width doors as partial overlay styles (14 1/2" wide) with a partial overlay hinge (38NPOHINGE) to allow for proper door clearance with adjacent cabinets.

Adjacent Cabinet Depth	Wall Width	Frame	Maximum Sink Width	Maximum Sink Depth
21"	33" x 33"	17"	25 3/4"	22 7/8"
18"	30" x 30"	17"	25 3/4"	18 5/8"

**Custom Modifications**

AUTHL	CBO	CCO	CFNTO	CFP	CFRMO	CMAT	CND	DRWPWR	DRWTK	EXBKL	EXL
				STD	•		•				
FB	FFDL FFDR	FPEB	FTK	FTKAV FTKFV	ID	INVFRM	LTI	MIP	RD	RECTKALL RECTKBK	RECTKL RECTKR
							•				
RT	TKP	TOTSS TOTSSS	VTK	WLI							

**Construction Upgrades**

APC	PE

**Door Options**

ALF	CG	DPSRR	MD	MFO
		•		

**VANITY ANGLE CORNER SINK FRONT  
BOTTOM**

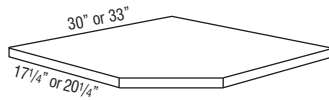

VACSF3018	1.0
VACSF3321	1.0

- Designed for use with Vanity Angle Corner Sink Front.
- 3/8" thick.
- Trimmable.

**Custom Modifications**

AUTHL	CBO	CCO	CFNTO	CFP	CFRMO	CMAT	CND	DRWPWR	DRWTK	EXBKL	EXL
FB	FFDL FFDR	FPEB	FTK	FTKAV FTKFV	ID	INVFRM	LTI	MIP	RD	RECTKALL RECTKBK	RECTKL RECTKR
RT	TKP	TOTSS TOTSSS	VTK	WLI							
							•				

**Construction Upgrades**

APC	PE
•	

**Door Options**

ALF	CG	DPSRR	MD	MFO

**UNDER COUNTER DRAWER,  
4 3/4" HIGH, 18" or 21" DEEP**

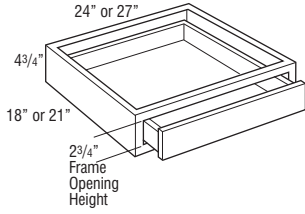

UCD2418 UCD2421  
UCD2718 UCD2721

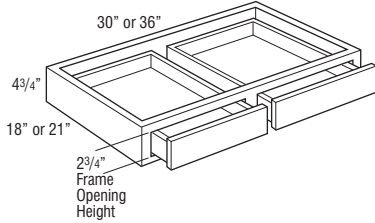

UCD3018 UCD3021  
UCD3618 UCD3621

Model	Cubic Feet	Model	Cubic Feet
UCD2418	2.6	UCD3018	2.6
UCD2718	2.6	UCD3618	2.6
UCD2421	2.6	UCD3021	2.6
UCD2721	2.6	UCD3621	2.6

- Cabinet is 4 3/4" high. Drawer box within cabinet is 2" high.
- Not trimmable.
- Drawer front is 3/4" slab front.
- The frame to end panel offset is 3/4", which is designed to accommodate the vanity desk leg.
- End panels ordered in Distinction will feature non-matching laminate exterior. When ordered in PE or APC, end panels will not be finished.
- Reduced depth is available in 3" increments.

**Custom Modifications**

AUTHL	AUTHR	CBO	CCO	CFNTO	CFP	CFRMO	CMAT	CND	DRWPWR	DRWTK	EXBKL	EXBKR	EXL	EXR
		•	•			•							•	•
FB	FFDL	FFDR	FPEB	FTK	FTKAV	FTKRV	ID	INVFRM	LTI	MIP	RD	RECTKALL	RECTKLBK	RECTKLR
										•	•			
RT	TKP	TOTSS	TOTSSS	VTK	WLI									

**Construction Upgrades**

APC	PE
•	•

**Door Options**

ALF	CG	DPSRR	MD	MFO

**SPECIAL SIZE VANITY, 32" HIGH,  
16" DEEP**

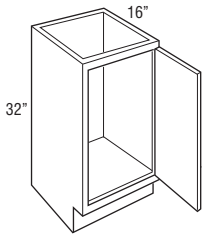

<b>MV183216 L or R</b>	<b>7.2</b>
------------------------	------------

- MV = mini-vanity.

**Custom Modifications**

AUTHL	AUTHR	CBO	CCO	CFNTO	CFP	CFRMO	CMAT	CND	DRWPWR	DRWTK	EXBKL	EXBKR	EXL	EXR
		•	•	•		•					•	•	•	•
FB	FFDL	FFDR	FPEB	FTK	FTKAV	FTKRV	ID	INVFRM	LTI	MIP	RD	RECTKALL	RECTKLBK	RECTKLR
•				•	•	•			•	•		•	•	•
RT	TKP	TOTSS	TOTSSS	VTK	WLI									
				•	•									

**Construction Upgrades**

APC	PE
•	•

**Door Options**

ALF	CG	DPSRR	MD	MFO
		•		

**SPECIAL SIZE VANITY,  
34 1/2" HIGH, 16" DEEP**

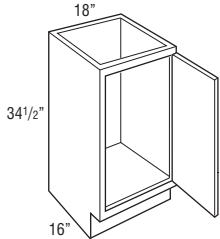

<b>MV183416 L or R</b>	<b>7.7</b>
------------------------	------------

- MV = mini-vanity.

**Custom Modifications**

AUTHL	AUTHR	CBO	CCO	CFNTO	CFP	CFRMO	CMAT	CND	DRWPWR	DRWTK	EXBKL	EXBKR	EXL	EXR
		•		•		•					•	•	•	•
FB	FFDL	FFDR	FPEB	FTK	FTKAV	FTKRV	ID	INVFRM	LTI	MIP	RD	RECTKALL	RECTKLBK	RECTKLR
•			•	•	•	•			•	•		•	•	•
RT	TKP	TOTSS	TOTSSS	VTK	WLI									
				•	•									

**Construction Upgrades**

APC	PE
•	•

**Door Options**

ALF	CG	DPSRR	MD	MFO
		•		

**VANITY HAMPER, 32" HIGH, 21" DEEP**

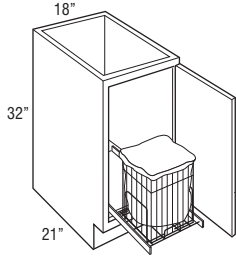

L G I X

Model	Cubic Feet
VH183221FH L or R	8.9

- Includes full extension removable chrome pull-out hamper with removable cloth liner.
- Hamper size is 19 3/8" high x 14 3/4" wide x 18" deep.

**Custom Modifications**

AUTHL AUTHR	CBO	CCO	CFNT0	CFP	CFRMO	CMAT	CND	DRWPWR	DRWTK	EXBKL EXBKR	EXL EXR
•	•	•	•	•	•		•		•	•	•
FB	FFDL FFDR	FPEB	FTK	FTKAV FTKFV	ID	INVFRM	LTI	MIP	RD	RECTKALL RECTKBK	RECTKL RECTKR
•		•	•	•				•		•	•
RT	TKP	TOTSS TOTSSS	VTK	WLI							
			•	•							

**Construction Upgrades**

APC	PE
•	•

**Door Options**

ALF	CG	DPSRR	MD	MFO
		•		

**VANITY HAMPER with DRAWER, 34 1/2" HIGH, 21" DEEP**

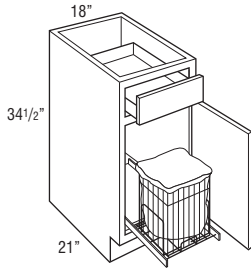

L G I X

Model	Cubic Feet
VBH183421 L or R	9.5

- Includes full extension removable chrome pull-out hamper with removable cloth liner.
- Hamper size is 19 3/8" high x 14 3/4" wide x 18" deep.

**Custom Modifications**

AUTHL AUTHR	CBO	CCO	CFNT0	CFP	CFRMO	CMAT	CND	DRWPWR	DRWTK	EXBKL EXBKR	EXL EXR
•	•	•	•	•	•		•		•	•	•
FB	FFDL FFDR	FPEB	FTK	FTKAV FTKFV	ID	INVFRM	LTI	MIP	RD	RECTKALL RECTKBK	RECTKL RECTKR
•		•	•	•				•		•	•
RT	TKP	TOTSS TOTSSS	VTK	WLI							
			•	•							

**Construction Upgrades**

APC	PE
•	•

**Door Options**

ALF	CG	DPSRR	MD	MFO
		•		

**LINEN CLOSET**

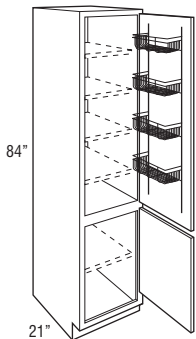

L G I X

Model	Cubic Feet
LC188421 L or R	23.0

- Upper section features a 5" deep chrome door rack.
- 15" deep adjustable shelves indicated by light dotted lines are included; packaged separately.
- If ordered in Arch door style, top door will be Arch and lower door will be Square.
- Tall non-mitered doors will have two center panels with cross rail.
- Tranter doors greater than 48" high will be two doors doweled together.
- Recommended for use with 34 1/2" high cabinets (bottom door will align with top of drawer front or top of full-height door).

**Custom Modifications**

AUTHL AUTHR	CBO	CCO	CFNT0	CFP	CFRMO	CMAT	CND	DRWPWR	DRWTK	EXBKL EXBKR	EXL EXR
	•	•	•		•					•	•
FB	FFDL FFDR	FPEB	FTK	FTKAV FTKFV	ID	INVFRM	LTI	MIP	RD	RECTKALL RECTKBK	RECTKL RECTKR
•		•	•	•		•		•			•
RT	TKP	TOTSS TOTSSS	VTK	WLI							
•	•		•	•							

**Construction Upgrades**

APC	PE
•	•

**Door Options**

ALF	CG	DPSRR	MD	MFO
		•		•

**LINEN CLOSET with REMOVABLE HAMPER**

L O G I X

Model	Cubic Feet
LCRH188421 L or R	23.0

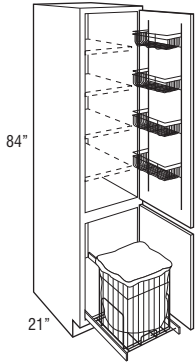

- Upper section features a 5" deep chrome door rack.
- 15" deep adjustable shelves indicated by light dotted lines are included; packaged separately.
- Includes full extension removable chrome pull-out hamper with removable cloth liner.
- Hamper size is 19 3/8" high x 14 3/4" wide x 18" deep.
- If ordered in Arch door style, top door will be Arch and lower door will be Square.
- Tall non-mitered doors will have two center panels with cross rail.
- Tranter doors greater than 48" high will be two doors doweled together.
- Recommended for use with 34 1/2" high cabinets (bottom door will align with top of drawer front or top of full-height door).

**Custom Modifications**

AUTHL AUTHR	CBO	CCO	CFNT0	CFP	CFRMO	CMAT	CND	DRWPWR	DRWTK	EXBKL EXBKR	EXL EXR
	•	•	•		•					•	•
FB	FFDL FFDR	FPEB	FTK	FTKAV FTKFV	ID	INVFRM	LTI	MIP	RD	RECTKALL RECTKBK	RECTKL RECTKR
•		•	•	•				•			•
RT	TKP	TOTSS TOTSSS	VTK	WLI							
	•		•	•							

**Construction Upgrades**

APC	PE
•	•

**Door Options**

ALF	CG	DPSRR	MD	MFO
		•		•

**LINEN STORAGE CABINET**

18" or 21"

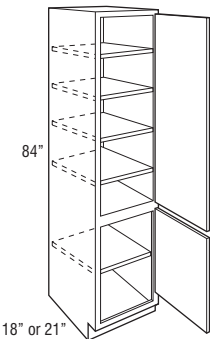

<b>LT188418 L or R</b>	<b>20.3</b>
<b>LT218418 L or R</b>	<b>23.4</b>
<b>LT188421 L or R</b>	<b>23.3</b>
<b>LT218421 L or R</b>	<b>26.8</b>

- If ordered in Arch door style, top door will be Arch and lower door will be Square.
- Tall non-mitered doors will have two center panels with cross rail.
- Tranter doors greater than 48" high will be two doors doweled together.
- Recommended for use with 34 1/2" high cabinets (bottom door will align with top of drawer front or top of full-height door).

**Custom Modifications**

AUTHL AUTHR	CBO	CCO	CFNT0	CFP	CFRMO	CMAT	CND	DRWPWR	DRWTK	EXBKL EXBKR	EXL EXR
	•	•	•		•				•*	•	•
FB	FFDL FFDR	FPEB	FTK	FTKAV FTKFV	ID	INVFRM	LTI	MIP	RD	RECTKALL RECTKBK	RECTKL RECTKR
•		•	•	•	•	•		•	•		•
RT	TKP	TOTSS TOTSSS	VTK	WLI							
•	•		•	•							

\*Not available on 18" deep

**Construction Upgrades**

APC	PE
•	•

**Door Options**

ALF	CG	DPSRR	MD	MFO
		•		•



**VANITY UTILITY,  
84" TALL, 21" DEEP**

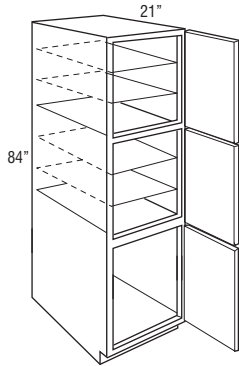

Model	Cubic Feet
<b>VU188421 L or R</b>	<b>23.0</b>

- Lower door section is drilled to accept adjustable shelf.
- Shelves indicated by light dotted lines are included; packaged separately.
- Shelves indicated by solid lines are fixed.
- Vanity utilities designed to be used with 32" tall vanities.
- If ordered in Arch door style, top door will be Arch and lower doors will be Square.

**Custom Modifications**

AUTHL AUTHR	CBO	CCO	CFNT0	CFP	CFRMO	CMAT	CND	DRWPWR	DRWTK	EXBKL EXBKR	EXL EXR
•	•	•	•		•				•	•	•
FB	FFDL FFDR	FPEB	FTK	FTKAV FTKFV	ID	INVFRM	LTI	MIP	RD	RECTKALL RECTKBK	RECTKL RECTKR
•			•	•	•			•	•		•
RT	TKP	TOTSS TOTSSS	VTK	WLI							
•	•		•	•							

**Construction Upgrades**

APC	PE
•	•

**Door Options**

ALF	CG	DPSRR	MD	MFO
		•		•

**VANITY WALL HUNG TWO DRAWER  
SINK BASE with FALSE PANEL,  
23 1/2" HIGH, 21" DEEP**

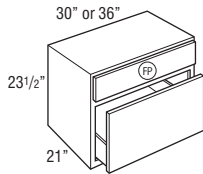

<b>VWH2D3023.521FP</b>	<b>10.7</b>
<b>VWH2D3623.521FP</b>	<b>12.7</b>

- Plumbing clearance of 15 1/16" to the top edge of the lower drawer box (6 3/8" high drawer box).
- For proper installation, cabinet must be secured on each side through both the top and bottom of the back panel into wall studs. Installation instructions and required 3 1/2" installation screws included, standard 2 1/2" installation screws are not sufficient in this application.
- 5-piece drawer front configuration will not match on door styles with unique rail widths for drawer fronts over 10" high. Check door style section on pages 10-25 for drawer rail widths by height.
- Features a full cabinet top that can be routed for sink installation.
- Approximate weight limit is 400 lbs. per cabinet (includes weight of the cabinet, countertop and contents). Proper installation is required and additional bracing may be required.

**Custom Modifications**

AUTHL AUTHR	CBO	CCO	CFNT0	CFP	CFRMO	CMAT	CND	DRWPWR	DRWTK	EXBKL EXBKR	EXL EXR
•	•	•			•						•
FB	FFDL FFDR	FPEB	FTK	FTKAV FTKFV	ID	INVFRM	LTI	MIP	RD	RECTKALL RECTKBK	RECTKL RECTKR
		STD						•	•		
RT	TKP	TOTSS TOTSSS	VTK	WLI							
				•							

**Construction Upgrades**

APC	PE
STD	

**Door Options**

ALF	CG	DPSRR	MD	MFO

**VANITY WALL HUNG TWO DRAWER  
BASE, 23 1/2" HIGH, 21" DEEP**

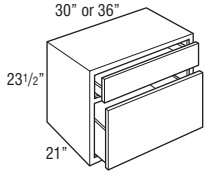

Model	Cubic Feet
VWH2D3023.521	10.7
VWH2D3623.521	12.7

- Top drawer box is 3 3/8" high, bottom drawer box is 10" high.
- Cannot be used with a sink due to drawer interference.
- For proper installation, cabinet must be secured on each side through both the top and bottom of the back panel into wall studs. Installation instructions and required 3 1/2" installation screws included, standard 2 1/2" installation screws are not sufficient in this application.
- 5-piece drawer front configuration will not match on door styles with unique rail widths for drawer fronts over 10" high. Check door style section on pages 10-25 for drawer rail widths by height.
- Approximate weight limit is 400 lbs. per cabinet (includes weight of the cabinet, countertop and contents). Proper installation is required and additional bracing may be required.

**Custom Modifications**

AUTHL AUTHR	CBO	CCO	CFNTO	CFP	CFRMO	CMAT	CND	DRWPWR	DRWTK	EXBKL EXBKR	EXL EXR
•	•	•		•	•			•			•
FB	FFDL FFDR	FPEB	FTK	FTKAV FTKRV	ID	INVFRM	LTI	MIP	RD	RECTKALL RECTKBK	RECTKL RECTKR
		STD						•	•		
RT	TKP	TOTSS TOTSSS	VTK	WLI							
				•							

**Construction Upgrades**

APC	PE
STD	

**Door Options**

ALF	CG	DPSRR	MD	MFO

**VANITY WALL HUNG DOUBLE DOOR  
with U-SHAPED PULL-OUTS,  
23 1/2" HIGH, 21" DEEP**

LOGIX

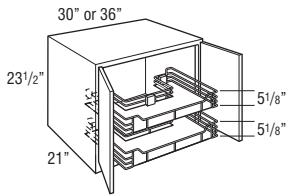

VWH3023.521U	10.7
VWH3623.521U	12.7

- Includes two chrome U-shaped Smart Stop roll-outs with non-slip gray shelf liner.
- Cut-out for U-shape on bottom roll-out is 6 1/8" from back of cabinet.
- Cut-out for U-shape on top roll-out is 12 1/8" from back of cabinet.
- For proper installation, cabinet must be secured on each side through both the top and bottom of the back panel into wall studs. Installation instructions and required 3 1/2" installation screws included, standard 2 1/2" installation screws are not sufficient in this application.
- Features a full cabinet top that can be routed for sink installation.
- Approximate weight limit is 400 lbs. per cabinet (includes weight of the cabinet, countertop and contents). Proper installation is required and additional bracing may be required.

**Custom Modifications**

AUTHL AUTHR	CBO	CCO	CFNTO	CFP	CFRMO	CMAT	CND	DRWPWR	DRWTK	EXBKL EXBKR	EXL EXR
•	•	•			•						•
FB	FFDL FFDR	FPEB	FTK	FTKAV FTKRV	ID	INVFRM	LTI	MIP	RD	RECTKALL RECTKBK	RECTKL RECTKR
		STD						•	•		
RT	TKP	TOTSS TOTSSS	VTK	WLI							
				•							

**Construction Upgrades**

APC	PE
STD	

**Door Options**

ALF	CG	DPSRR	MD	MFO
		•		

**VANITY WALL HUNG DOUBLE DOOR,  
23 1/2" HIGH, 21" DEEP**

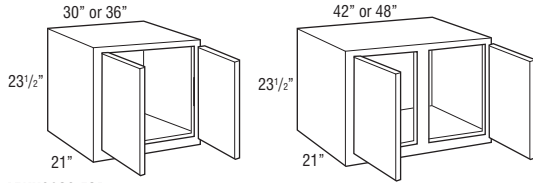

**VWH3023.521**  
**VWH3623.521**

**VWH4223.521**  
**VWH4823.521CS**

Model	Cubic Feet
<b>VWH3023.521</b>	10.7
<b>VWH3623.521</b>	12.7
<b>VWH4223.521</b>	14.8
<b>VWH4823.521CS</b>	16.8

- For proper installation, cabinet must be secured on each side through both the top and bottom of the back panel into wall studs. Installation instructions and required 3 1/2" installation screws included, standard 2 1/2" installation screws are not sufficient in this application.
- Features a full cabinet top that can be routed for sink installation.
- Approximate weight limit is 400 lbs. per cabinet (includes weight of the cabinet, countertop and contents). Proper installation is required and additional bracing may be required.

**Custom Modifications**

AUTHL	AUTHR	CBO	CCO	CFNTO	CFP	CFRMO	CMAT	CND	DRWPWR	DRWTK	EXBKL	EXBKR	EXL	EXR
			•	•		•								•
FB	FFDL FFDR	FPEB	FTK	FTKAV FTKFV	ID	INVFRM	LTI	MIP	RD	RECTKLL RECTKKB	RECTKL RECTKR			
			STD					•	•	•				
RT	TKP	TOTSS TOTSSS	VTK	WLI										
					•									

**Construction Upgrades**

APC	PE
•	STD

**Door Options**

ALF	CG	DPSRR	MD	MFO
	•	•		

**VANITY WALL TOWEL BAR**

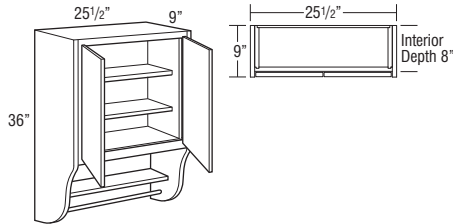

<b>VWTB24</b>	<b>6.8</b>
---------------	------------

- Includes 2 adjustable interior shelves, 1 fixed shelf, and towel rack underneath.
- Cabinet has butt doors, no center stile.
- Cabinet features factory applied 3/4" matching veneer over furniture board core end panels. Total cabinet width is 25 1/2".
- Interior cabinet case has plywood end panels.
- When ordered in APC, back, top, bottom and adjustable shelves are plywood.

**Custom Modifications**

AUTHL	AUTHR	CBO	CCO	CFNTO	CFP	CFRMO	CMAT	CND	DRWPWR	DRWTK	EXBKL	EXBKR	EXL	EXR
		•	•	•		•								
FB	FFDL FFDR	FPEB	FTK	FTKAV FTKFV	ID	INVFRM	LTI	MIP	RD	RECTKLL RECTKKB	RECTKL RECTKR			
									•					
RT	TKP	TOTSS TOTSSS	VTK	WLI										
					•									

**Construction Upgrades**

APC	PE
•	
	STD

**Door Options**

ALF	CG	DPSRR	MD	MFO
	•	•		•

**VANITY WALL, 30" HIGH, 6" DEEP**

12", 15", 18", or 24"

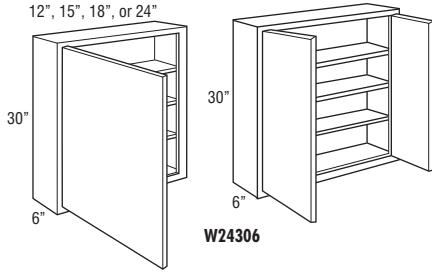

W12306 L or R  
W15306 L or R  
W18306 L or R  
W24306 L or R

Model	Cubic Feet
W12306 L or R	2.2
W15306 L or R	2.6
W18306 L or R	3.1
W24306 L or R	4.0
<b>W24306</b>	<b>4.0</b>

**Custom Modifications**

AUTHL	AUTHR	CBO	CCO	CFNTO	CFP	CFRMO	CMAT	CND	DRWPWR	DRWTK	EXBKL	EXBKR	EXL	EXR
		•	•	•		•					•	•		
FB	FFDL	FFDR	FPEB	FTK	FTKAV	FTKRV	ID	INVFRM	LTI	MIP	RD	RECTKALL	RECTKLBK	RECTKLR
•			•							•				
RT	TKP	TOTSS	TOTSSS	VTK	WLI									
					•									

**Construction Upgrades**

APC	PE
•	•

**Door Options**

ALF	CG	DPSRR	MD	MFO
•†	•	•	•	•

†Not available on 24" wide

**VANITY WALL MIRROR CABINET, 30" HIGH, 4 9/16" DEEP**

18" or 24"

30" or 36"

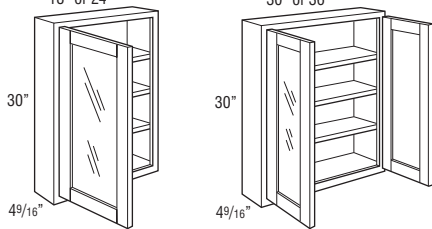

VWM1830 L or R  
VWM2430 L or R

VWM3030  
VWM3630

VWM1830 L or R	2.7
VWM2430 L or R	3.5
<b>VWM3030</b>	<b>4.3</b>
<b>VWM3630</b>	<b>5.1</b>
<b>VWM4230</b>	<b>5.9</b>

- Standard with CG doors and installed mirror glass.
- Unit intended to be surface mounted. Features standard 1/4" face frame reveal on ends.
- Not available in Catalina, Granite, Tranter, Trystan, Wixom, and Worthen styles.
- Adjustable shelves.

**Custom Modifications**

AUTHL	AUTHR	CBO	CCO	CFNTO	CFP	CFRMO	CMAT	CND	DRWPWR	DRWTK	EXBKL	EXBKR	EXL	EXR
		•	•	•		•					•	•		
FB	FFDL	FFDR	FPEB	FTK	FTKAV	FTKRV	ID	INVFRM	LTI	MIP	RD	RECTKALL	RECTKLBK	RECTKLR
•			•							•				
RT	TKP	TOTSS	TOTSSS	VTK	WLI									
					•									

**Construction Upgrades**

APC	PE
•	•

**Door Options**

ALF	CG	DPSRR	MD	MFO
	STD			

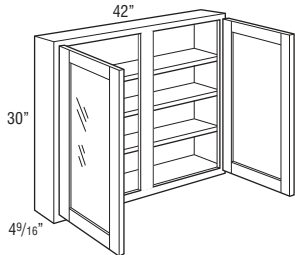

VWM4230

**VANITY MIRROR with SIDE PULL-OUTS, 32 1/2" HIGH, 4 7/8" DEEP**

L G I X

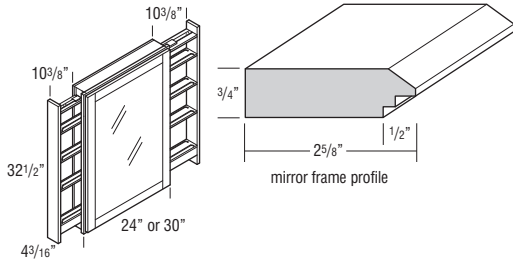

Model	Cubic Feet
VMP2432.5	3.7
VMP3032.5	4.6

- One full extension natural wood finish pull-out on each side with three adjustable shelves and chrome rail sides (Smart Stop not included).
- Pull-outs extend 10 3/8" on each side. VMP2432.5 open width is 44 3/4". VMP3032.5 open width is 50 3/4".
- Mirror frame has a shaker outside profile and a bevel inside profile with a 1/4" face frame reveal. Mirror is not removable.
- Mirror visible dimensions:  
VMP2432.5 - 26 3/4" high x 18 1/4" wide  
VMP3032.5 - 26 3/4" high x 24 1/4" wide
- Installation instructions included.
- When Distressing is selected, only fillers will receive treatment.
- When Heirlooming is selected, only mirror frame will receive treatment.
- Pull-outs feature plain fillers. If a more decorative look is desired, overlay fillers or embellishments may be ordered separately and field installed.

MODIFICATIONS
No modifications available for these products.

Finish Techniques	
Distressing	Heirlooming
•	•

**Species Availability (Wood)**

Alder	Rustic Alder	Cherry	Hickory	Maple	Oak
		•		•	

**Species Availability (All Laminates)**

High Gloss box color	Horiz. Grain on Maple box color	Vert. Grain on Maple box color	Vert. Grain on Cherry box color	Vert. Grain on Hickory	Vert. Grain on Oak	Thermofoil box color

**VANITY MIRROR**

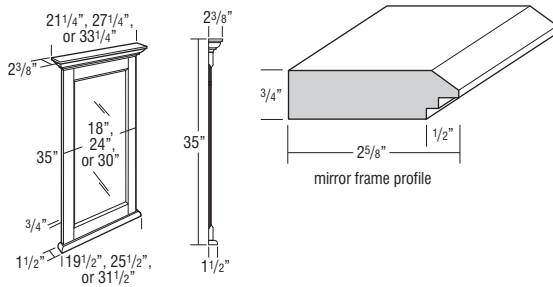

VM2135	5.4
VM2735	5.4
VM3335	5.4

- Moulding included on vanity mirror is not a standard moulding. SWLCRM8 is similar.
- Mirror glass is beveled.
- Includes two installed metal hanging hooks on back.

MODIFICATIONS
No modifications available for these products.

Finish Techniques	
Distressing	Heirlooming
	•

**Species Availability (Wood)**

Alder	Rustic Alder	Cherry	Hickory	Maple	Oak
		•		•	

**Species Availability (All Laminates)**

High Gloss box color	Horiz. Grain on Maple box color	Vert. Grain on Maple box color	Vert. Grain on Cherry box color	Vert. Grain on Hickory	Vert. Grain on Oak	Thermofoil box color

Model	Overall Dimensions Width	Overall Dimensions Height	Mirror - Visible Dimensions Width	Mirror - Visible Dimensions Height
VM2135	21 1/4"	35"	12 15/16"	26 15/16"
VM2735	27 1/4"	35"	18 15/16"	26 15/16"
VM3335	33 1/4"	35"	24 15/16"	26 15/16"

**SINGLE DOOR MEDICINE CABINET**

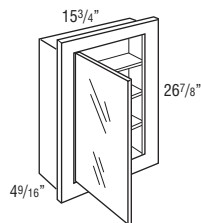

Model	Cabinet Dimensions			Cut-out Dimensions		
	Width	Height	Depth	Width	Height	Depth
MC16	15 3/4"	26 7/8"	4 9/16"	14 7/16"	25 5/8"	4"

Model	Cubic Feet
MC16	2.5

- Unit can be surface mounted or recessed.
- Door of cabinet is glass mirror.
- Matching cabinet doors not available.
- Cabinet has wood frame.
- Finished exterior.
- Standard interior.
- Face frame has a profiled inside and outside edge.
- If ordered with Heirloom Technique, will not feature sand-through characteristics.

**Custom Modifications**

AUTHL	CBO	CCO	CFNT0	CFP	CFRMO	CMAT	CND	DRWPWR	DRWTK	EXBKL	EXL
	•	•			•						
FB	FFDL FFDR	FPEB	FTK	FTKAV FTKRV	ID	INVERM	LTI	MIP	RD	RECTKALL RECTKBK	RECTKL RECTKR
STD								•			
RT	TKP	TOTSS TOTSSS	VTK	WLI							
				•							

**Construction Upgrades**

APC	PE
STD	

**Door Options**

ALF	CG	DPSRR	MD	MFO

**TRI-VIEW MEDICINE CABINET**

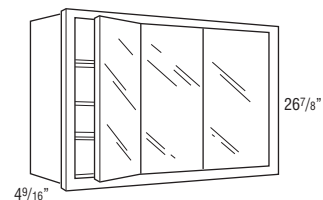

Model	Cabinet Dimensions			Cut-out Dimensions		
	Width	Height	Depth	Width	Height	Depth
TV30	30"	26 7/8"	4 9/16"	28 11/16"	25 5/8"	4"
TV36	36"	26 7/8"	4 9/16"	34 11/16"	25 5/8"	4"
TV48	48"	26 7/8"	4 9/16"	46 11/16"	25 5/8"	4"

<b>TV30</b>	5.4
<b>TV36</b>	6.5
<b>TV48</b>	8.5

- Cabinet has wood frame.
- Door of cabinet is glass mirror.
- Unit can be surface mounted or recessed.
- Finished exterior.
- Standard interior.
- Face frame has a profiled inside and outside edge.
- If ordered with Heirloom Technique, will not feature sand-through characteristics.

**Custom Modifications**

AUTHL	CBO	CCO	CFNT0	CFP	CFRMO	CMAT	CND	DRWPWR	DRWTK	EXBKL	EXL
	•	•			•						
FB	FFDL FFDR	FPEB	FTK	FTKAV FTKRV	ID	INVERM	LTI	MIP	RD	RECTKALL RECTKBK	RECTKL RECTKR
STD								•			
RT	TKP	TOTSS TOTSSS	VTK	WLI							
				•							

**Construction Upgrades**

APC	PE
STD	

**Door Options**

ALF	CG	DPSRR	MD	MFO

## SPECIES AVAILABILITY

Species Availability charts list the availability of each product code by species and any substitutions that are made. Exceptions within a section are noted below the species availability chart.

For panels with doors and/or fillers attached, species availability is shown for the panel and filler only.

For Species Availability, look for this chart throughout. For trim items ordered with Laminates, trim items matching the cabinet box color are noted in the charts.

MDF door styles will use Maple for trim and panels, refer to Maple in the Species Availability charts.

### Species Availability (Wood)

Alder	Rustic Alder	Cherry	Hickory	Maple	Oak
•	•	•	•	•	•

### Species Availability (All Laminates)

High Gloss	Horiz. Grain on Maple	Vert. Grain on Maple	Vert. Grain on Cherry	Vert. Grain on Hickory	Vert. Grain on Oak	Thermofoil
box color	box color	box color	box color	box color	box color	box color

## DESCRIPTION

## MODEL

### FILLERS

#### 3" WIDE FILLERS

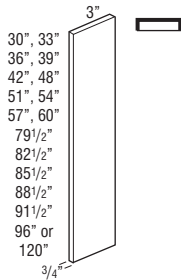

F3



F330

F333

F336

F339

F342

F348

F351

F354

F357

F360

TF384

TF387

TF390

TF393

TF396

TF396FH

TF3120FH† ♦

- 3/4" thick.
- Finished on front and all edges (backs are not finished).
- †5 day Express Response not available.

#### Finish Techniques

Distressing	Heirlooming
•	

#### Species Availability (Wood)

Alder	Rustic Alder	Cherry	Hickory	Maple	Oak
•	•	•	•	•	•

♦ Only available in Cherry and Maple.

#### Species Availability (All Laminates)

High Gloss	Horiz. Grain on Maple	Vert. Grain on Maple	Vert. Grain on Cherry	Vert. Grain on Hickory	Vert. Grain on Oak	Thermofoil
box color	box color	box color	box color	box color	box color	box color

♦ Only available in Cherry and Maple box colors.

#### 3" WIDE FILLER RETURN



F3R



F3R

- Creates a toekick appearance when used with 3" wide fillers.
- 3/8" thick, Natural Maple laminated furniture board.

## DESCRIPTION

## MODEL

#### 3" WIDE CORNER FILLER

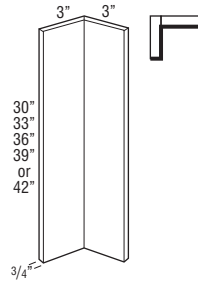

CF3



CF330

CF333

CF336

CF339

CF342

- 3/4" thick.
- Finished on front and all edges (backs are not finished).

#### Finish Techniques

Distressing	Heirlooming
•	

#### Species Availability (Wood)

Alder	Rustic Alder	Cherry	Hickory	Maple	Oak
•	•	•	•	•	•

#### Species Availability (All Laminates)

High Gloss	Horiz. Grain on Maple	Vert. Grain on Maple	Vert. Grain on Cherry	Vert. Grain on Hickory	Vert. Grain on Oak	Thermofoil
box color	box color	box color	box color	box color	box color	box color

#### 6" WIDE FILLERS

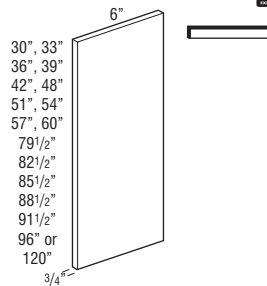

F6



F630

F633

F636

F639

F642

F648

F651

F654

F657

F660

TF684

TF687

TF690

TF693

TF696

TF696FH

TF6120FH† ♦

- 3/4" thick.
- Finished on front and all edges (backs are not finished).
- †5 day Express Response not available.

#### Finish Techniques

Distressing	Heirlooming
•	

#### Species Availability (Wood)

Alder	Rustic Alder	Cherry	Hickory	Maple	Oak
•	•	•	•	•	•

♦ Only available in Cherry and Maple.

#### Species Availability (All Laminates)

High Gloss	Horiz. Grain on Maple	Vert. Grain on Maple	Vert. Grain on Cherry	Vert. Grain on Hickory	Vert. Grain on Oak	Thermofoil
box color	box color	box color	box color	box color	box color	box color

♦ Only available in Cherry and Maple box colors.

#### 6" WIDE FILLER RETURN

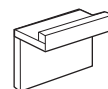

F6R



F6R

- Creates a toekick appearance when used with 6" wide fillers.
- 3/8" thick, Natural Maple laminated furniture board.

Finished edges indicated by bold lines on side view drawings.  
Glazed edges indicated by arrows on side view drawings.

DESCRIPTION

MODEL

SPACE FILLERS



S96X14 (1/4" thick)

S96X12 (1/2" thick)

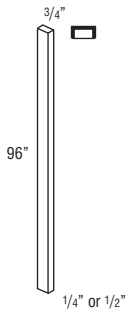

- S96 is 1/4" or 1/2" thick.
- Designed to fill space between adjacent cabinets; i.e. W1830 butted against side of U188424.
- Finished on front and all edges (backs are not finished).

Finish Techniques

Distressing	Heirlooming
•	•

Species Availability (Wood)

Alder	Rustic Alder	Cherry	Hickory	Maple	Oak
•	•	•	•	•	•

Species Availability (All Laminates)

High Gloss box color	Horiz. Grain on Maple box color	Vert. Grain on Maple box color	Vert. Grain on Cherry box color	Vert. Grain on Hickory box color	Vert. Grain on Oak box color	Thermofoil box color
						•

OVERLAY FILLER, 2 1/2" WIDE



OL312 (11 1/2"H)

OL315 (14 1/2"H)

OL318 (17 1/2"H)

OL321 (20 1/2"H)

OL324 (23 1/2"H)

OL327 (26 1/2"H)

OL330 (28"H or 29 1/2"H)

OL333 (31"H or 32 1/2"H)

OL336 (34"H or 35 1/2"H)

OL339 (37"H or 38 1/2"H)

OL342 (40"H or 41 1/2"H)

OL384 (79"H)

OL387 (82"H)

OL390 (85"H)

OL393 (88"H)

OL396 (91"H)

VOL332 (27"H)

DOL329 (24"H)

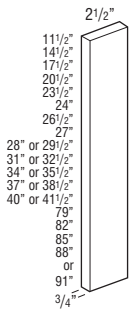

- All overlay fillers available in full overlay door styles.
- OL330, OL333, OL336, OL339, OL342 also available in partial overlay door styles. Overlays for partial overlay door styles will match partial overlay door height.
- 2 1/2" wide overlay fillers can be applied to Wall Message Centers to create custom finished look.
- Overlays match door profile and thickness.
- See page 7 for list of full overlay styles.
- Finished on front and all edges (backs are not finished).
- See OL\_\_MFO (on right) for use with Modified Full Overlay modification.
- Maple will be used for MDF overlays.

Finish Techniques

Distressing	Heirlooming
•	•

Species Availability (Wood)

Alder	Rustic Alder	Cherry	Hickory	Maple	Oak
•	•	•	•	•	•

Species Availability (All Laminates)

High Gloss	Horiz. Grain on Maple	Vert. Grain on Maple	Vert. Grain on Cherry	Vert. Grain on Hickory	Vert. Grain on Oak	Thermofoil
						•

DESCRIPTION

MODEL

OVERLAY FILLER for MODIFIED FULL OVERLAY, 2 1/2" WIDE



OL312MFO (10 3/4"H)

OL315MFO (13 3/4"H)

OL318MFO (16 3/4"H)

OL321MFO (19 3/4"H)

OL324MFO (22 3/4"H)

OL327MFO (25 3/4"H)

OL330MFO (28 3/4"H)

OL333MFO (31 3/4"H)

OL336MFO (34 3/4"H)

OL339MFO (37 3/4"H)

OL342MFO (40 3/4"H)

OL384MFO (78 1/4"H)

OL387MFO (81 1/4"H)

OL390MFO (84 1/4"H)

OL393MFO (87 1/4"H)

OL396MFO (90 1/4"H)

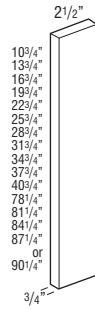

- All overlay fillers available in full overlay door styles except Catalina, Trystan, and Worthen.
- Height will align with doors specified with Modified Full Overlay modification. See page 40 for MFO details.
- 2 1/2" wide overlay fillers can be applied to Wall Message Centers to create a custom finished look.
- Overlays match door profile and thickness.
- Finished on front and all edges (backs are not finished).
- Not available in MDF door styles.

Finish Techniques

Distressing	Heirlooming
•	•

Species Availability (Wood)

Alder	Rustic Alder	Cherry	Hickory	Maple	Oak
•	•	•	•	•	•

Species Availability (All Laminates)

High Gloss	Horiz. Grain on Maple	Vert. Grain on Maple	Vert. Grain on Cherry	Vert. Grain on Hickory	Vert. Grain on Oak	Thermofoil
						•

Finished edges indicated by bold lines on side view drawings.  
Glazed edges indicated by arrows on side view drawings.



**DESCRIPTION**

**OVERLAY FILLER, PREMIUM,  
2 1/2" WIDE**

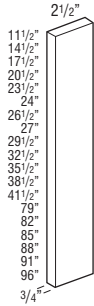

**MODEL**

- OL312P** (11 1/2"H)
- OL315P** (14 1/2"H)
- OL318P** (17 1/2"H)
- OL321P** (20 1/2"H)
- OL324P** (23 1/2"H)
- OL327P** (26 1/2"H)
- OL330P** (29 1/2"H)
- OL333P** (32 1/2"H)
- OL336P** (35 1/2"H)
- OL339P** (38 1/2"H)
- OL342P** (41 1/2"H)
- OL384P** (79"H)
- OL387P** (82"H)
- OL390P** (85"H)
- OL393P** (88"H)
- OL396P** (91"H)
- OL396FHP** (96"H)
- VOL332P** (27"H)
- DOL329P** (24"H)

- Overlays match door profile and thickness.
- Front, edges, and backs match door and drawer front construction.
- Wixom edgebanding will match door and drawer front edgebanding selection.
- Tranter overlays feature horizontal grain. Overlays greater than 48" high will be two overlays and require field assembly (allow 3/16" gap between overlays for alignment with adjacent doors).

**Finish Techniques**

Distressing	Heirlooming

**Species Availability (Wood)**

Alder	Rustic Alder	Cherry	Hickory	Maple	Oak

**Species Availability (All Laminates)**

High Gloss	Horiz. Grain on Maple	Vert. Grain on Maple	Vert. Grain on Cherry	Vert. Grain on Hickory	Vert. Grain on Oak	Thermofoil
•	•	•	•	•	•	

**DESCRIPTION**

**NEW** **OVERLAY FILLER  
for MODIFIED FULL  
OVERLAY, PREMIUM,  
2 1/2" WIDE**

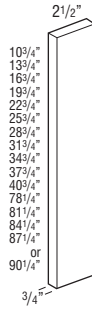

**MODEL**

- OL312MFOP** (10 3/4"H)
- OL315MFOP** (13 3/4"H)
- OL318MFOP** (16 3/4"H)
- OL321MFOP** (19 3/4"H)
- OL324MFOP** (22 3/4"H)
- OL327MFOP** (25 3/4"H)
- OL330MFOP** (28 3/4"H)
- OL333MFOP** (31 3/4"H)
- OL336MFOP** (34 3/4"H)
- OL339MFOP** (37 3/4"H)
- OL342MFOP** (40 3/4"H)
- OL384MFOP** (78 1/4"H)
- OL387MFOP** (81 1/4"H)
- OL390MFOP** (84 1/4"H)
- OL393MFOP** (87 1/4"H)
- OL396MFOP** (90 1/4"H)

- Overlays match door profile and thickness.
- Front, edges, and backs match door and drawer front construction.
- Height will align with doors specified with Modified Full Overlay modification. See page 40 for MFO details.
- Wixom edgebanding will match door and drawer front edgebanding selection.
- Tranter overlays feature horizontal grain. Overlays greater than 48" high will be two overlays and require field assembly (allow 3/16" gap between overlays for alignment with adjacent doors).

**Finish Techniques**

Distressing	Heirlooming

**Species Availability (Wood)**

Alder	Rustic Alder	Cherry	Hickory	Maple	Oak

**Species Availability (All Laminates)**

High Gloss	Horiz. Grain on Maple	Vert. Grain on Maple	Vert. Grain on Cherry	Vert. Grain on Hickory	Vert. Grain on Oak	Thermofoil
•	•	•	•	•	•	

Finished edges indicated by bold lines on side view drawings.  
Glazed edges indicated by arrows on side view drawings.

**DESCRIPTION**

**OVERLAY FILLER,  
5 1/2" WIDE**

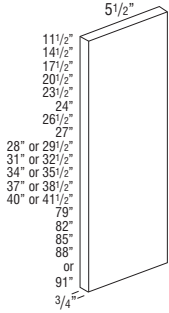

**MODEL**

- OL612** (11 1/2"H)
- OL615** (14 1/2"H)
- OL618** (17 1/2"H)
- OL621** (20 1/2"H)
- OL624** (23 1/2"H)
- OL627** (26 1/2"H)
- OL630** (28"H or 29 1/2"H)
- OL633** (31"H or 32 1/2"H)
- OL636** (34"H or 35 1/2"H)
- OL639** (37"H or 38 1/2"H)
- OL642** (40"H or 41 1/2"H)
- OL684** (79"H)
- OL687** (82"H)
- OL690** (85"H)
- OL693** (88"H)
- OL696** (91"H)
- VOL632** (27"H)
- DOL629** (24"H)

- All overlay fillers available in full overlay door styles.
- OL630, OL633, OL636, OL639, OL642 also available in partial overlay door styles. Overlays for partial overlay door styles will match partial overlay door height.
- Overlays match door profile and thickness.
- See page 7 for list of full overlay styles.
- Finished on front and all edges (backs are not finished).
- See OL\_\_MFO (on right) for use with Modified Full Overlay modification.
- Maple will be used for MDF overlays.

**Finish Techniques**

Distressing	Heirlooming
•	•

**Species Availability (Wood)**

Alder	Rustic Alder	Cherry	Hickory	Maple	Oak
•	•	•	•	•	•

**Species Availability (All Laminates)**

High Gloss	Horiz. Grain on Maple	Vert. Grain on Maple	Vert. Grain on Cherry	Vert. Grain on Hickory	Vert. Grain on Oak	Thermofoil
						•

**DESCRIPTION**

**OVERLAY FILLER  
for MODIFIED FULL  
OVERLAY, 5 1/2" WIDE**

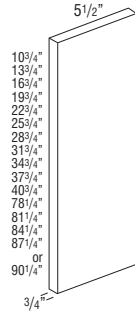

**MODEL**

- OL612MFO** (10 3/4"H)
- OL615MFO** (13 3/4"H)
- OL618MFO** (16 3/4"H)
- OL621MFO** (19 3/4"H)
- OL624MFO** (22 3/4"H)
- OL627MFO** (25 3/4"H)
- OL630MFO** (28 3/4"H)
- OL633MFO** (31 3/4"H)
- OL636MFO** (34 3/4"H)
- OL639MFO** (37 3/4"H)
- OL642MFO** (40 3/4"H)
- OL684MFO** (78 1/4"H)
- OL687MFO** (81 1/4"H)
- OL690MFO** (84 1/4"H)
- OL693MFO** (87 1/4"H)
- OL696MFO** (90 1/4"H)

- All overlay fillers available in full overlay door styles except Catalina, Trystan, and Worthen.
- Height will align with doors specified with Modified Full Overlay modification. See page 40 for MFO details.
- Overlays match door profile and thickness.
- Finished on front and all edges (backs are not finished).
- Not available in MDF door styles.

**Finish Techniques**

Distressing	Heirlooming
•	•

**Species Availability (Wood)**

Alder	Rustic Alder	Cherry	Hickory	Maple	Oak
•	•	•	•	•	•

**Species Availability (All Laminates)**

High Gloss	Horiz. Grain on Maple	Vert. Grain on Maple	Vert. Grain on Cherry	Vert. Grain on Hickory	Vert. Grain on Oak	Thermofoil

Finished edges indicated by bold lines on side view drawings.  
Glazed edges indicated by arrows on side view drawings.

**DESCRIPTION**

**MODEL**

**OVERLAY FILLER, PREMIUM,  
5 1/2" WIDE**

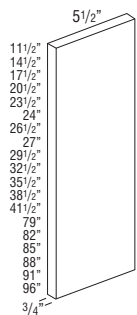

<b>OL612P</b> (11 1/2"H)
<b>OL615P</b> (14 1/2"H)
<b>OL618P</b> (17 1/2"H)
<b>OL621P</b> (20 1/2"H)
<b>OL624P</b> (23 1/2"H)
<b>OL627P</b> (26 1/2"H)
<b>OL630P</b> (29 1/2"H)
<b>OL633P</b> (32 1/2"H)
<b>OL636P</b> (35 1/2"H)
<b>OL639P</b> (38 1/2"H)
<b>OL642P</b> (41 1/2"H)
<b>OL684P</b> (79"H)
<b>OL687P</b> (82"H)
<b>OL690P</b> (85"H)
<b>OL693P</b> (88"H)
<b>OL696P</b> (91"H)
<b>OL696FHP</b> (96"H)
<b>VOL632P</b> (27"H)
<b>DOL629P</b> (24"H)

- Overlays match door profile and thickness.
- Front, edges, and backs match door and drawer front construction.
- Wixom edgebanding will match door and drawer front edgebanding selection.
- Tranter overlays feature horizontal grain. Overlays greater than 48" high will be two overlays and require field assembly (allow 3/16" gap between overlays for alignment with adjacent doors).

**Finish Techniques**

Distressing	Heirlooming

**Species Availability (Wood)**

	Rustic Alder	Cherry	Hickory	Maple	Oak

**Species Availability (All Laminates)**

High Gloss	Horiz. Grain on Maple	Vert. Grain on Maple	Vert. Grain on Cherry	Vert. Grain on Hickory	Vert. Grain on Oak	Thermofoil
•	•	•	•	•	•	

**DESCRIPTION**

**MODEL**

**NEW** **OVERLAY FILLER  
for MODIFIED FULL  
OVERLAY, PREMIUM,  
5 1/2" WIDE**

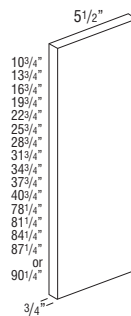

<b>OL612MFOP</b> (10 3/4"H)
<b>OL615MFOP</b> (13 3/4"H)
<b>OL618MFOP</b> (16 3/4"H)
<b>OL621MFOP</b> (19 3/4"H)
<b>OL624MFOP</b> (22 3/4"H)
<b>OL627MFOP</b> (25 3/4"H)
<b>OL630MFOP</b> (28 3/4"H)
<b>OL633MFOP</b> (31 3/4"H)
<b>OL636MFOP</b> (34 3/4"H)
<b>OL639MFOP</b> (37 3/4"H)
<b>OL642MFOP</b> (40 3/4"H)
<b>OL684MFOP</b> (78 1/4"H)
<b>OL687MFOP</b> (81 1/4"H)
<b>OL690MFOP</b> (84 1/4"H)
<b>OL693MFOP</b> (87 1/4"H)
<b>OL696MFOP</b> (90 1/4"H)

- Overlays match door profile and thickness.
- Front, edges, and backs match door and drawer front construction.
- Height will align with doors specified with Modified Full Overlay modification. See page 40 for MFO details.
- Wixom edgebanding will match door and drawer front edgebanding selection.
- Tranter overlays feature horizontal grain. Overlays greater than 48" high will be two overlays and require field assembly (allow 3/16" gap between overlays for alignment with adjacent doors).

**Finish Techniques**

Distressing	Heirlooming

**Species Availability (Wood)**

	Rustic Alder	Cherry	Hickory	Maple	Oak

**Species Availability (All Laminates)**

High Gloss	Horiz. Grain on Maple	Vert. Grain on Maple	Vert. Grain on Cherry	Vert. Grain on Hickory	Vert. Grain on Oak	Thermofoil
•	•	•	•	•	•	

Finished edges indicated by bold lines on side view drawings.  
Glazed edges indicated by arrows on side view drawings.

DESCRIPTION

MODEL

FLUTED/BEADED 3" WIDE REVERSIBLE FILLERS



FBF330 (3" x 30")  
 FBF336 (3" x 36")  
 TFBF396 (3" x 96")

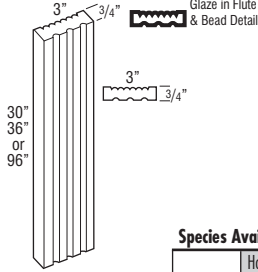

Finish Techniques

Distressing	Heirlooming
	•

Species Availability (Wood)

Alder	Rustic Alder	Cherry	Hickory	Maple	Oak
•	Alder	•	•	•	•

Species Availability (All Laminates)

High Gloss box color	Horiz. Grain on Maple box color	Vert. Grain on Maple box color	Vert. Grain on Cherry box color	Vert. Grain on Hickory box color	Vert. Grain on Oak box color	Thermofoil box color
----------------------	---------------------------------	--------------------------------	---------------------------------	----------------------------------	------------------------------	----------------------

FLUTED/BEADED 6" WIDE REVERSIBLE FILLERS



FBF630 (6" x 30")  
 FBF636 (6" x 36")  
 TFBF696 (6" x 96")

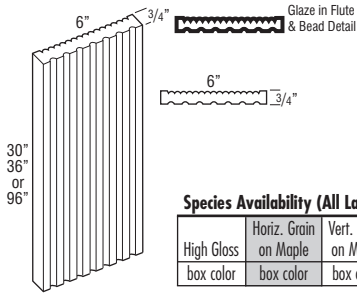

Finish Techniques

Distressing	Heirlooming
	•

Species Availability (Wood)

Alder	Rustic Alder	Cherry	Hickory	Maple	Oak
•	Alder	•	•	•	•

Species Availability (All Laminates)

High Gloss box color	Horiz. Grain on Maple box color	Vert. Grain on Maple box color	Vert. Grain on Cherry box color	Vert. Grain on Hickory box color	Vert. Grain on Oak box color	Thermofoil box color
----------------------	---------------------------------	--------------------------------	---------------------------------	----------------------------------	------------------------------	----------------------

ANGLED FLUTED/PLAIN 3" WIDE REVERSIBLE FILLERS



BLVDF30 (3" x 30")  
 BLVDF34.5 (3" x 34 1/2")  
 BLVDTF96 (3" x 96")

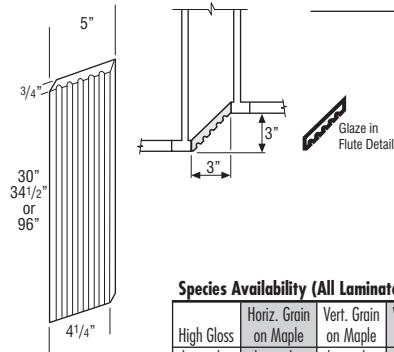

Finish Techniques

Distressing	Heirlooming
	•

Species Availability (Wood)

Alder	Rustic Alder	Cherry	Hickory	Maple	Oak
•	Alder	•	•	•	•

Species Availability (All Laminates)

High Gloss box color	Horiz. Grain on Maple box color	Vert. Grain on Maple box color	Vert. Grain on Cherry box color	Vert. Grain on Hickory box color	Vert. Grain on Oak box color	Thermofoil box color
----------------------	---------------------------------	--------------------------------	---------------------------------	----------------------------------	------------------------------	----------------------

DESCRIPTION

MODEL

BOX COLUMN FILLERS, 3" WIDE Wall - Plain Column 15" Deep

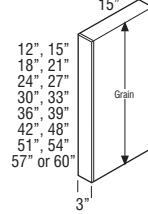

W312BCFP  
 W315BCFP  
 W318BCFP  
 W321BCFP  
 W324BCFP  
 W327BCFP  
 W330BCFP  
 W333BCFP  
 W336BCFP  
 W339BCFP  
 W342BCFP  
 W348BCFP  
 W351BCFP  
 W354BCFP  
 W357BCFP  
 W360BCFP

Custom Modifications

ID	RD
•	•

Finish Techniques

Distressing	Heirlooming
•	

Species Availability (Wood)

Alder	Rustic Alder	Cherry	Hickory	Maple	Oak
•	Alder	•	•	•	•

Species Availability (All Laminates)

High Gloss box color	Horiz. Grain on Maple box color	Vert. Grain on Maple box color	Vert. Grain on Cherry box color	Vert. Grain on Hickory box color	Vert. Grain on Oak box color	Thermofoil box color
----------------------	---------------------------------	--------------------------------	---------------------------------	----------------------------------	------------------------------	----------------------

Wall - Fluted Column 15" Deep

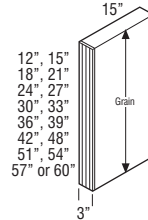

W312BCFF  
 W315BCFF  
 W318BCFF  
 W321BCFF  
 W324BCFF  
 W327BCFF  
 W330BCFF  
 W333BCFF  
 W336BCFF  
 W339BCFF  
 W342BCFF  
 W348BCFF  
 W351BCFF  
 W354BCFF  
 W357BCFF  
 W360BCFF

Custom Modifications

ID	RD
•	•

Finish Techniques

Distressing	Heirlooming
•	•

Species Availability (Wood)

Alder	Rustic Alder	Cherry	Hickory	Maple	Oak
•	Alder	•	•	•	•

Species Availability (All Laminates)

High Gloss box color	Horiz. Grain on Maple box color	Vert. Grain on Maple box color	Vert. Grain on Cherry box color	Vert. Grain on Hickory box color	Vert. Grain on Oak box color	Thermofoil box color
----------------------	---------------------------------	--------------------------------	---------------------------------	----------------------------------	------------------------------	----------------------

Finished edges indicated by bold lines on side view drawings.  
 Glazed edges indicated by arrows on side view drawings.

**DESCRIPTION**

**MODEL**

**BOX COLUMN FILLERS,  
3" WIDE (cont'd)  
Wall - Beaded Column  
15" Deep**

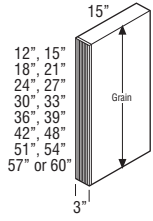

- W312BCFB
- W315BCFB
- W318BCFB
- W321BCFB
- W324BCFB
- W327BCFB
- W330BCFB
- W333BCFB
- W336BCFB
- W339BCFB
- W342BCFB
- W348BCFB
- W351BCFB
- W354BCFB
- W357BCFB
- W360BCFB

- Available in 1" depth increments from 6" to 27".
- Reversible, may be used on either left or right end.
- Front and both sides finished.
- Enclosed top and bottom.
- 1/2" plywood construction.
- Finished veneer on end panel exterior.
- No reveal on filler.

Custom Modifications		Finish Techniques	
ID	RD	Distressing	Heirlooming
•	•		•

Species Availability (Wood)					
Alder	Rustic Alder	Cherry	Hickory	Maple	Oak
•	Alder	•	•	•	•

Species Availability (All Laminates)						
High Gloss	Horiz. Grain on Maple	Vert. Grain on Maple	Vert. Grain on Cherry	Vert. Grain on Hickory	Vert. Grain on Oak	Thermofoil
box color	box color	box color	box color	box color	box color	box color

**DESCRIPTION**

**MODEL**

**BOX COLUMN FILLERS, 3" WIDE  
Base - Plain, Fluted, Beaded Column  
27" Deep**

Custom Modifications		Finish Techniques	
ID	RD	Distressing	Heirlooming
	•	•	

Species Availability (Wood)					
Alder	Rustic Alder	Cherry	Hickory	Maple	Oak
•	Alder	•	•	•	•

Species Availability (All Laminates)						
High Gloss	Horiz. Grain on Maple	Vert. Grain on Maple	Vert. Grain on Cherry	Vert. Grain on Hickory	Vert. Grain on Oak	Thermofoil
box color	box color	box color	box color	box color	box color	box color

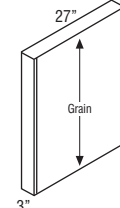

3" Plain

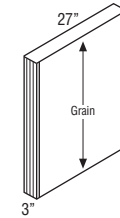

3" Fluted

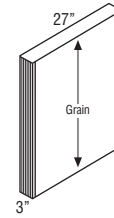

3" Beaded

**B334.527BCFF  
B334.527BCFB**

- Available in 1" depth increments from 6" to 27".
- Reversible, may be used on either left or right end.
- Front and both sides finished.
- Enclosed top and bottom.
- 1/2" plywood construction.
- Finished veneer on end panel exterior.
- No reveal on filler.

Custom Modifications		Finish Techniques	
ID	RD	Distressing	Heirlooming
	•		•

Species Availability (Wood)					
Alder	Rustic Alder	Cherry	Hickory	Maple	Oak
•	Alder	•	•	•	•

Species Availability (All Laminates)						
High Gloss	Horiz. Grain on Maple	Vert. Grain on Maple	Vert. Grain on Cherry	Vert. Grain on Hickory	Vert. Grain on Oak	Thermofoil
box color	box color	box color	box color	box color	box color	box color

**DESCRIPTION**

**BOX COLUMN FILLERS, 3" WIDE**  
**Tall - Plain Column**  
**15" & 27" Deep**

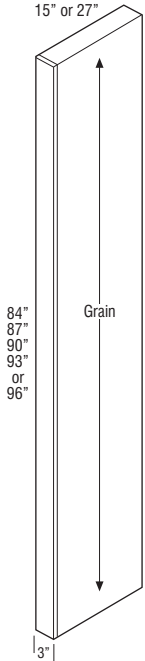

**Tall - Fluted Column**  
**15" & 27" Deep**

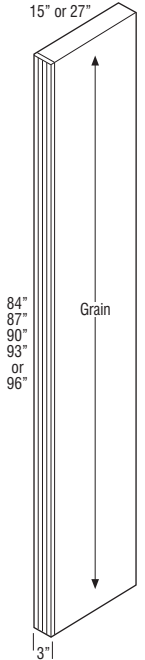

**MODEL**

- T38415BCFP (15" Deep)
- T38715BCFP (15" Deep)
- T39015BCFP (15" Deep)
- T39315BCFP (15" Deep)
- T39615BCFP (15" Deep)
- T38427BCFP (27" Deep)
- T38727BCFP (27" Deep)
- T39027BCFP (27" Deep)
- T39327BCFP (27" Deep)
- T39627BCFP (27" Deep)

Custom Modifications		Finish Techniques	
ID	RD	Distressing	Heirlooming
•*	•	•	•

\*ID only available on 15" deep.

**Species Availability (Wood)**

Alder	Rustic Alder	Cherry	Hickory	Maple	Oak
•	•	•	•	•	•

**Species Availability (All Laminates)**

High Gloss box color	Horiz. Grain on Maple box color	Vert. Grain on Maple box color	Vert. Grain on Cherry box color	Vert. Grain on Hickory box color	Vert. Grain on Oak box color	Thermofoil box color
•	•	•	•	•	•	•

**DESCRIPTION**

**BOX COLUMN FILLERS, 3" WIDE (cont'd)**  
**Tall - Beaded Column**  
**15" & 27" Deep**

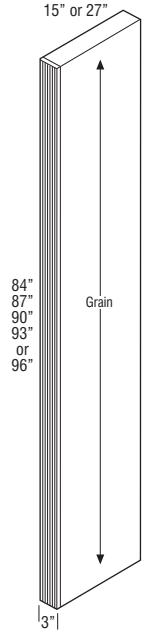

**MODEL**

- T38415BCFB (15" Deep)
- T38715BCFB (15" Deep)
- T39015BCFB (15" Deep)
- T39315BCFB (15" Deep)
- T39615BCFB (15" Deep)
- T38427BCFB (27" Deep)
- T38727BCFB (27" Deep)
- T39027BCFB (27" Deep)
- T39327BCFB (27" Deep)
- T39627BCFB (27" Deep)

- Available in 1" depth increments from 6" to 27".
- Reversible, may be used on either left or right end.
- Front and both sides finished.
- Enclosed top and bottom.
- 1/2" plywood construction.
- Finished veneer on end panel exterior.
- No reveal on filler.

Custom Modifications		Finish Techniques	
ID	RD	Distressing	Heirlooming
•*	•	•	•

\*ID only available on 15" deep.

**Species Availability (Wood)**

Alder	Rustic Alder	Cherry	Hickory	Maple	Oak
•	•	•	•	•	•

**Species Availability (All Laminates)**

High Gloss box color	Horiz. Grain on Maple box color	Vert. Grain on Maple box color	Vert. Grain on Cherry box color	Vert. Grain on Hickory box color	Vert. Grain on Oak box color	Thermofoil box color
•	•	•	•	•	•	•

**BOX COLUMN FILLERS, 6" WIDE**  
**Wall - Plain Column**  
**15" Deep**

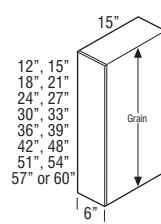

- W612BCFP
- W615BCFP
- W618BCFP
- W621BCFP
- W624BCFP
- W627BCFP
- W630BCFP
- W633BCFP
- W636BCFP
- W639BCFP
- W642BCFP
- W648BCFP
- W651BCFP
- W654BCFP
- W657BCFP
- W660BCFP

- T38415BCFF (15" Deep)
- T38715BCFF (15" Deep)
- T39015BCFF (15" Deep)
- T39315BCFF (15" Deep)
- T39615BCFF (15" Deep)
- T38427BCFF (27" Deep)
- T38727BCFF (27" Deep)
- T39027BCFF (27" Deep)
- T39327BCFF (27" Deep)
- T39627BCFF (27" Deep)

Custom Modifications		Finish Techniques	
ID	RD	Distressing	Heirlooming
•*	•	•	•

\*ID only available on 15" deep.

**Species Availability (Wood)**

Alder	Rustic Alder	Cherry	Hickory	Maple	Oak
•	•	•	•	•	•

**Species Availability (All Laminates)**

High Gloss box color	Horiz. Grain on Maple box color	Vert. Grain on Maple box color	Vert. Grain on Cherry box color	Vert. Grain on Hickory box color	Vert. Grain on Oak box color	Thermofoil box color
•	•	•	•	•	•	•

Custom Modifications		Finish Techniques	
ID	RD	Distressing	Heirlooming
•	•	•	•

**Species Availability (Wood)**

Alder	Rustic Alder	Cherry	Hickory	Maple	Oak
•	•	•	•	•	•

**Species Availability (All Laminates)**

High Gloss box color	Horiz. Grain on Maple box color	Vert. Grain on Maple box color	Vert. Grain on Cherry box color	Vert. Grain on Hickory box color	Vert. Grain on Oak box color	Thermofoil box color
•	•	•	•	•	•	•

**DESCRIPTION**

**MODEL**

**BOX COLUMN FILLERS,  
6" WIDE (cont'd)  
Wall - Fluted Column  
15" Deep**

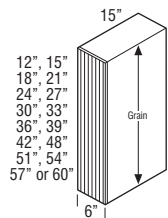

- W612BCFF
- W615BCFF
- W618BCFF
- W621BCFF
- W624BCFF
- W627BCFF
- W630BCFF
- W633BCFF
- W636BCFF
- W639BCFF
- W642BCFF
- W648BCFF
- W651BCFF
- W654BCFF
- W657BCFF
- W660BCFF

**Custom Modifications**

ID	RD
•	•

**Finish Techniques**

Distressing	Heirlooming
	•

**Species Availability (Wood)**

Alder	Rustic Alder	Cherry	Hickory	Maple	Oak
•	Alder	•	•	•	•

**Species Availability (All Laminates)**

High Gloss	Horiz. Grain on Maple	Vert. Grain on Maple	Vert. Grain on Cherry	Vert. Grain on Hickory	Vert. Grain on Oak	Thermofoil
box color	box color	box color	box color	box color	box color	box color

**DESCRIPTION**

**MODEL**

**BOX COLUMN FILLERS,  
6" WIDE (cont'd)  
Wall - Beaded Column  
15" Deep**

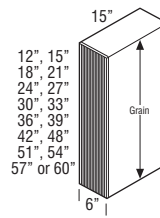

- W612BCFB
- W615BCFB
- W618BCFB
- W621BCFB
- W624BCFB
- W627BCFB
- W630BCFB
- W633BCFB
- W636BCFB
- W639BCFB
- W642BCFB
- W648BCFB
- W651BCFB
- W654BCFB
- W657BCFB
- W660BCFB

- Available in 1" depth increments from 6" to 27".
- Reversible, may be used on either left or right end.
- Front and both sides finished.
- Enclosed top and bottom.
- 1/2" plywood construction.
- Finished veneer on end panel exterior.
- No reveal on filler.

**Custom Modifications**

ID	RD
•	•

**Finish Techniques**

Distressing	Heirlooming
	•

**Species Availability (Wood)**

Alder	Rustic Alder	Cherry	Hickory	Maple	Oak
•	Alder	•	•	•	•

**Species Availability (All Laminates)**

High Gloss	Horiz. Grain on Maple	Vert. Grain on Maple	Vert. Grain on Cherry	Vert. Grain on Hickory	Vert. Grain on Oak	Thermofoil
box color	box color	box color	box color	box color	box color	box color

DESCRIPTION

MODEL

**BOX COLUMN FILLERS, 6" WIDE**  
**Base - Plain, Fluted, Beaded Column**  
**27" Deep**

**B634.527BCFP**

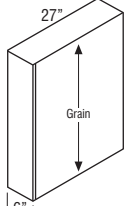

Plain

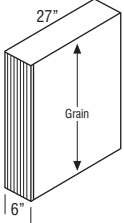

Fluted

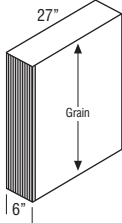

Beaded

**Custom Modifications**

ID	RD
	•

**Finish Techniques**

Distressing	Heirlooming
•	

**Species Availability (Wood)**

Alder	Rustic Alder	Cherry	Hickory	Maple	Oak
•	Alder	•	•	•	•

**Species Availability (All Laminates)**

High Gloss box color	Horiz. Grain on Maple box color	Vert. Grain on Maple box color	Vert. Grain on Cherry box color	Vert. Grain on Hickory box color	Vert. Grain on Oak box color	Thermofoil box color

**B634.527BCFF**

**B634.527BCFB**

- Available in 1" depth increments from 6" to 27".
- Reversible, may be used on either left or right end.
- Front and both sides finished.
- Enclosed top and bottom.
- 1/2" plywood construction.
- Finished veneer on end panel exterior.
- No reveal on filler.

**Custom Modifications**

ID	RD
	•

**Finish Techniques**

Distressing	Heirlooming
	•

**Species Availability (Wood)**

Alder	Rustic Alder	Cherry	Hickory	Maple	Oak
•	Alder	•	•	•	•

**Species Availability (All Laminates)**

High Gloss box color	Horiz. Grain on Maple box color	Vert. Grain on Maple box color	Vert. Grain on Cherry box color	Vert. Grain on Hickory box color	Vert. Grain on Oak box color	Thermofoil box color

**BOX COLUMN FILLERS, 6" WIDE**  
**Tall - Plain Column**  
**15" & 27" Deep**

**T68415BCFP** (15" Deep)

**T68715BCFP** (15" Deep)

**T69015BCFP** (15" Deep)

**T69315BCFP** (15" Deep)

**T69615BCFP** (15" Deep)

**T68427BCFP** (27" Deep)

**T68727BCFP** (27" Deep)

**T69027BCFP** (27" Deep)

**T69327BCFP** (27" Deep)

**T69627BCFP** (27" Deep)

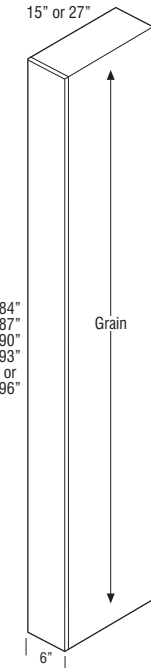

**Custom Modifications**

ID	RD
•*	•

**Finish Techniques**

Distressing	Heirlooming
•	

\*ID only available on 15" deep.

**Species Availability (Wood)**

Alder	Rustic Alder	Cherry	Hickory	Maple	Oak
•	Alder	•	•	•	•

**Species Availability (All Laminates)**

High Gloss box color	Horiz. Grain on Maple box color	Vert. Grain on Maple box color	Vert. Grain on Cherry box color	Vert. Grain on Hickory box color	Vert. Grain on Oak box color	Thermofoil box color

DESCRIPTION

MODEL

**BOX COLUMN FILLERS, 6" WIDE (cont'd)**  
**Tall - Fluted Column**  
**15" & 27" Deep**

**T68415BCFF** (15" Deep)

**T68715BCFF** (15" Deep)

**T69015BCFF** (15" Deep)

**T69315BCFF** (15" Deep)

**T69615BCFF** (15" Deep)

**T68427BCFF** (27" Deep)

**T68727BCFF** (27" Deep)

**T69027BCFF** (27" Deep)

**T69327BCFF** (27" Deep)

**T69627BCFF** (27" Deep)

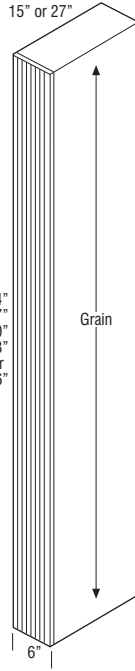

84"  
87"  
90"  
93"  
or  
96"

**Custom Modifications**

ID	RD
•*	•

**Finish Techniques**

Distressing	Heirlooming
	•

\*ID only available on 15" deep.

**Species Availability (Wood)**

Alder	Rustic Alder	Cherry	Hickory	Maple	Oak
•	Alder	•	•	•	•

**Species Availability (All Laminates)**

High Gloss box color	Horiz. Grain on Maple box color	Vert. Grain on Maple box color	Vert. Grain on Cherry box color	Vert. Grain on Hickory box color	Vert. Grain on Oak box color	Thermofoil box color

**Tall - Beaded Column**  
**15" & 27" Deep**

**T68415BCFB** (15" Deep)

**T68715BCFB** (15" Deep)

**T69015BCFB** (15" Deep)

**T69315BCFB** (15" Deep)

**T69615BCFB** (15" Deep)

**T68427BCFB** (27" Deep)

**T68727BCFB** (27" Deep)

**T69027BCFB** (27" Deep)

**T69327BCFB** (27" Deep)

**T69627BCFB** (27" Deep)

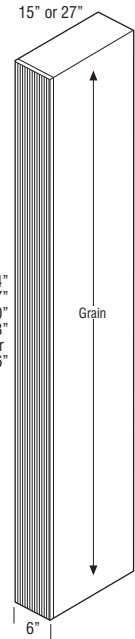

84"  
87"  
90"  
93"  
or  
96"

**Custom Modifications**

ID	RD
•*	•

**Finish Techniques**

Distressing	Heirlooming
	•

\*ID only available on 15" deep.

**Species Availability (Wood)**

Alder	Rustic Alder	Cherry	Hickory	Maple	Oak
•	Alder	•	•	•	•

**Species Availability (All Laminates)**

High Gloss box color	Horiz. Grain on Maple box color	Vert. Grain on Maple box color	Vert. Grain on Cherry box color	Vert. Grain on Hickory box color	Vert. Grain on Oak box color	Thermofoil box color



**WAINSCOTING, 34 1/2" or 40 1/2" HIGH**

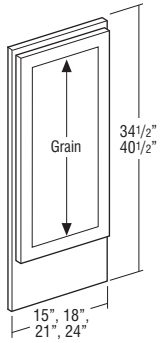

WAIN1534.5 WAIN1540.5  
 WAIN1834.5 WAIN1840.5  
 WAIN2134.5 WAIN2140.5  
 WAIN2434.5 WAIN2440.5

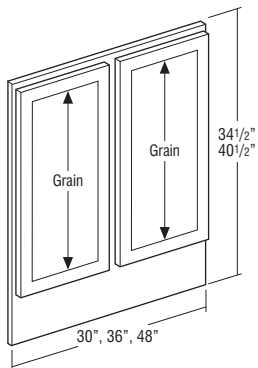

WAIN3034.5 WAIN3040.5  
 WAIN3634.5 WAIN3640.5  
 WAIN4834.5 WAIN4840.5

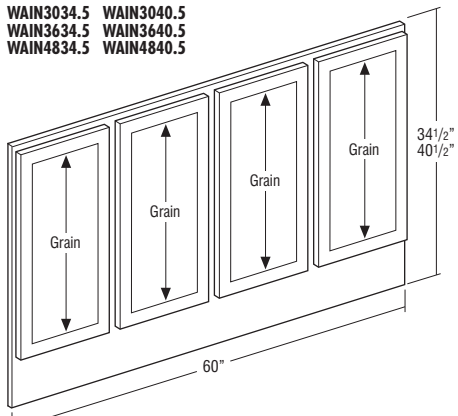

WAIN6034.5 WAIN6040.5

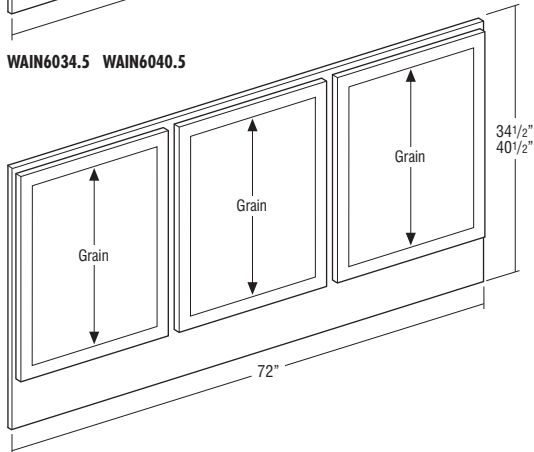

WAIN7234.5 WAIN7240.5

Model	Cubic Feet
WAIN1534.5	1.2
WAIN1834.5	1.4
WAIN2134.5	1.7
WAIN2434.5	1.9
WAIN1540.5	1.4
WAIN1840.5	1.7
WAIN2140.5	1.9
WAIN2440.5	2.2
WAIN3034.5	2.3
WAIN3634.5	2.8
WAIN4834.5	3.6
WAIN3040.5	2.7
WAIN3640.5	3.2
WAIN4840.5	7.3
WAIN6034.5	4.5
WAIN6040.5	5.3
WAIN7234.5	5.4
WAIN7240.5	6.3

- Full Overlay Styles only.
- Panel is 1 1/2" thick including doors. Non-operating doors are applied to 3/4" thick rail and stile frame.
- Flush ToeKick standard.
- Wainscoting panel backs are not finished, but are sealed to prevent warping and cracking.
- All faces and edges will be finished.
- If order is placed in Arch door style, panel will have Square doors.
- For use on bars or islands, attach panel by securing the panel face frame through the inside of the applicable cabinet.
- For wall applications, the screw heads used for the panel face frame attachment to the wall can be concealed behind the doors and drawer fronts.

Product Code	Overall Width	Number of Doors	Number of Frame Center Stiles	Door Width
WAIN15..	15"	1	0	14 1/2"
WAIN18..	18"	1	0	17 1/2"
WAIN21..	21"	1	0	20 1/2"
WAIN24..	24"	1	0	23 1/2"
WAIN30..	30"	2	1	14 1/2"
WAIN36..	36"	2	1	17 1/2"
WAIN48..	48"	2	1	23 1/2"
WAIN60..	60"	4	3	14 1/2"
WAIN72..	72"	3	2	23 1/2"

Door height on 34 1/2" high panels is 29 1/2".  
 Door height on 40 1/2" high panels is 35 1/2".

**Custom Modifications**

EXL	FTK	VTK
EXR	STD	
•		•

**Door Options**

DPSRR
•

**Finish Techniques**

Distressing	Heirlooming
•	•

**CUSTOM HINGED DOORS**

**Custom Doors with Hinge Routing**

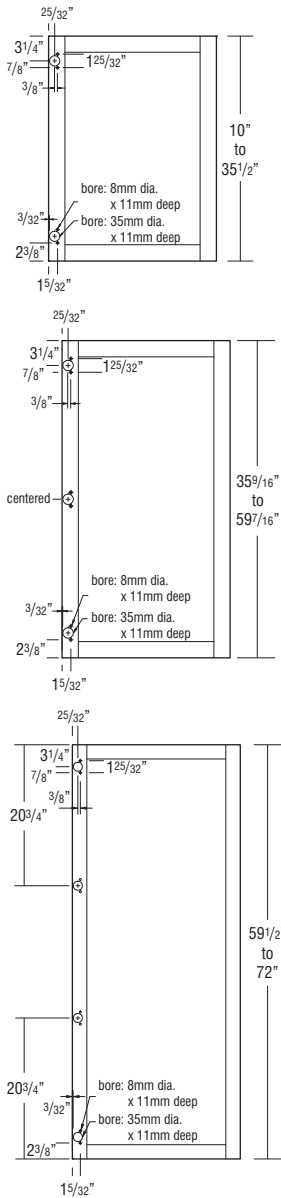

**DOORB**

**DOORBR**

**DOORWL**

**DOORWR**

- Base doors (DOORB and DOORBR) will always be square.
- Wall doors must specify square/arch.
- Plastic mollies pressed in 8mm holes to accept screws to anchor the hinges to the back of these doors.
- Hinges must be ordered separately and specified full or partial overlay.
- Available in all door styles except Catalina, Graniti, Tranter, Trystan, Wixom, and Worthen. For Graniti, Tranter, and Wixom, use DOORSLAB (see page 361). For Catalina, Trystan, and Worthen, standard door sizes must be ordered.
- Doors are finished on both sides and routed for hinges.
- CG modification available, maximum size is 23 1/2" x 43".
- Custom dimensions are required when placing order and can be specified in 20/20 or on the order form.
- Not available on MDF door styles. If desired for use with MDF, order as Maple.

**Finish Techniques**

Distressing	Heirlooming
•	•

	Model	Door Style Type	Available Width Range*	Available Height Range
	DOORB.. and DOORW..	Non-Miter Square or Arch Styles	7 1/2" to 24" (<3" wide rails/stiles) 8 1/2" to 24" (3" wide rails/stiles)	10" to 47 7/16" (<3" wide rails/stiles) 10" to 47 7/16" (3" wide rails/stiles)
	DOORB.. and DOORW..	Non-Miter Square or Arch Styles	7 1/2" to 24" (<3" wide rails/stiles) 8 1/2" to 24" (3" wide rails/stiles)	47 1/2" to 72" (<3" wide rails/stiles) 47 1/2" to 72" (3" wide rails/stiles)
	DOORB.. and DOORW..	Miter Styles	8" to 24"	10" to 61"

\*Any door with a minimum width dimension less than 10" will receive a flat center panel.

**DESCRIPTION**

**MODEL**

**Custom Doors with Hinge Routing, Slab Styles**

**DOORSLAB**

- Available in slab door styles: Graniti, Tranter, and Wixom.
- Doors are finished on both sides and routed for hinges.
- Hinges must be ordered separately and specified full overlay.
- Plastic mollies pressed in 8mm holes to accept screws to anchor the hinges to the back of these doors.
- Custom dimensions are required when placing order and can be specified in 20/20 or on the order form.

**Finish Techniques**

Distressing	Heirlooming
-------------	-------------

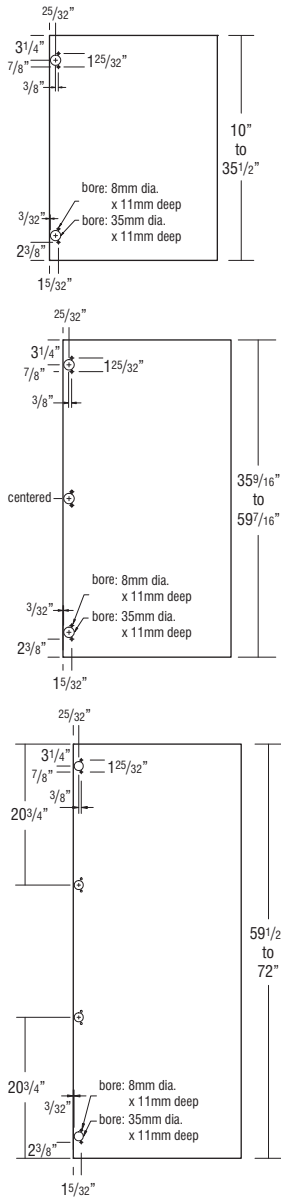

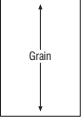
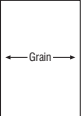
	Model	Door Style Type	Available Width Range	Available Height Range
	DOORSLAB	Vertical Grain or High Gloss	5" to 24"	10" to 72"
	DOORSLAB	Horizontal Grain	5" to 24"	10" to 48"

**DESCRIPTION MODEL**  
**DECORATIVE APPLIANCE PANELS**

All custom panels and doors can be ordered through 20/20. For manual orders, please fax the order form to customer service. See page 364.

Due to customized ordering, Decorative Appliance Panels may not be returned.

**Custom Panels & Doors (DAPNL.. and DADOOR..) square footage requirements are calculated by multiplying the height and width for each panel and door (square footage = width x height (in inches)/144).**

**Custom Panels**

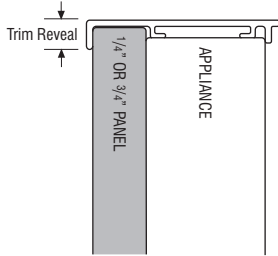

**DAPNL1/4**  
**DAPNL3/4**

- DAPNL1/4 includes 1/4" finished veneer on MDF core, panel cut to fit appliance doors. Panels mount to the appliance using trim kits provided by the appliance supplier.
- DAPNL1/4 is finished on face only, edges are not finished.
- DAPNL3/4 kit includes 3/4" furniture board core veneer panel finished on both sides, and all four edges. Panel is cut to fit appliance doors, and mounts to the appliance using trim kits provided by the appliance supplier.
- Custom sizes available in 1/16" increments.
- DAPNL3/4 can be ordered in APC.

	Maximum Width	Minimum Width	Maximum Height	Minimum Height
DAPNL1/4	48"	5"	96"	5"
DAPNL3/4*	48"	5"	48"	5"
DAPNL3/4**	30"	5"	96"	5"

\*If DAPNL3/4 is 48" high or less  
\*\*If DAPNL3/4 is greater than 48" high  
Grain on panels will follow the height dimension (vertical)

**Finish Techniques**

Distressing	Heirlooming

**Species Availability (Wood)**

Alder	Rustic Alder	Cherry	Hickory	Maple	Oak
•		•	•	•	•

**Species Availability (All Laminates)**

High Gloss	Horiz. Grain on Maple	Vert. Grain on Maple	Vert. Grain on Cherry	Vert. Grain on Hickory	Vert. Grain on Oak	Thermofoil
box color	box color	box color	box color	box color	box color	box color

**DESCRIPTION MODEL**  
**Custom Panels, Premium**

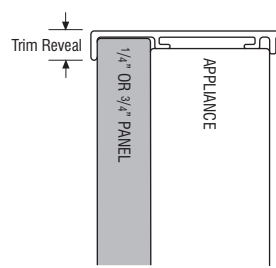

**DAPNL1/4P**  
**DAPNL3/4P**  
**DAPNL1/4HGP**  
**DAPNL3/4HGP**

- DAPNL1/4P and DAPNL1/4HGP are 1/4" thick laminated MDF panels cut to fit appliance doors. Laminated on face only, edges are not finished.
- DAPNL3/4P and DAPNL3/4HGP are 3/4" thick laminated MDF panels. Vertical and horizontal grain panels are laminated on both sides with edgebanding on all four edges. High Gloss panels have high gloss on front of panel, back of panel is white melamine. Edgebanding on all four edges will match door and drawer front edgebanding selection.
- DAPNL1/4P and DAPNL3/4P are available for use with Granit or Worthen featuring vertical grain or with Wixom featuring high gloss.
- DAPNL1/4HGP and DAPNL3/4HGP are available for use with Tranter featuring horizontal grain.
- Panel is cut to fit appliance doors, and mounts to the appliance using trim kits provided by the appliance supplier.
- Custom sizes available in 1/16" increments.

Model	Panel Type	Maximum Width	Minimum Width	Maximum Height	Minimum Height
DAPNL1/4P	Vertical Grain or High Gloss	48"	5"	96"	5"
DAPNL3/4P (48" high or less)	Vertical Grain or High Gloss	48"	5"	48"	5"
DAPNL3/4P (>48" high)	Vertical Grain or High Gloss	30"	5"	96"	5"
DAPNL1/4HGP	Horizontal Grain	96"	5"	48"	5"
DAPNL3/4HGP	Horizontal Grain	48"	5"	48"	5"
DAPNL3/4HGP (>48" wide)	Horizontal Grain	96"	5"	30"	5"

**Finish Techniques**

Distressing	Heirlooming

**Species Availability (Wood)**

Alder	Rustic Alder	Cherry	Hickory	Maple	Oak

**Species Availability (All Laminates)**

High Gloss	Horiz. Grain on Maple	Vert. Grain on Maple	Vert. Grain on Cherry	Vert. Grain on Hickory	Vert. Grain on Oak	Thermofoil
•	•*	•	•	•	•	

\*Only available on DAPNL1/4HGP and DAPNL3/4HGP.

**DESCRIPTION**

**MODEL**

**Custom Doors**

Overlay Application (with Backer Panel)

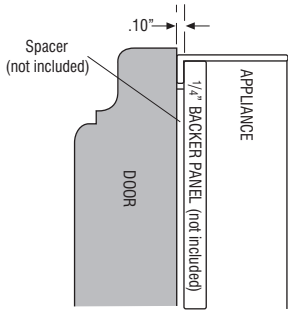

Overlay Application (no Backer Panel)

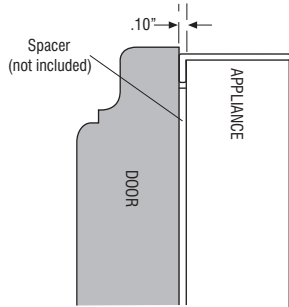

Framed Application

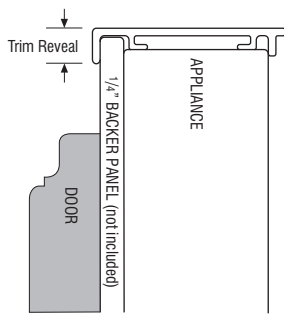

**Square Profile:**

**DADOORB**

**Arch Profile:**

**DADOORW**

**Horizontal Grain, Square Profile:**

**DADOORHG**

- DADOORB is a custom sized door with a square door profile (Arch styles will always be square).
- DADOORW is a custom sized door with the door profile matching the selected door style profile (Arch styles will be Arch).
- DADOORHG is a custom sized door with a square door profile (even when ordered in an Arch style). Stiles and rails are built as doors with a single center panel.
- DADOORHG center panel grain runs horizontal.
- DADOORHG will utilize a flat panel on raised panel styles when width or height is less than 10".
- Includes a 3/4" thick door made to a custom size for the appliance front. No backer panel included.
  - Some appliances require a .10" spacer and/or a 1/4" backer panel.
  - The 1/4" backer panel may be ordered separately (see DAPNLI/4).
- All doors will be specified "NO HINGE ROUTE". Backs may have identification marks, be unfinished, and have 3/16" diameter holes used during finish processing. For these reasons, these doors are not suitable for use as cabinet doors.
- DADOORB and DADOORW not available in Catalina, Graniti, Tranter, Trystan, Wixom, and Warthen. DADOORHG not available in Catalina, Graniti, Liberty, Tranter, Trystan, Wixom, and Warthen. For Decorative Appliance Panels, standard door sizes must be ordered.
- Custom sizes available in 1/16" increments.
- CG modification available, maximum size is 23 1/2" x 43" for DADOORB and DADOORW, and 43" x 23 1/2" for DADOORHG.
- Not available on MDF door styles. If desired for use with MDF, order as Maple.

**Finish Techniques**

Distressing	Heirlooming
•	•

	Model	Door Style Type	Available Width Range*	Available Height Range*
	DADOORB and DADOORW	Non-Miter Square or Arch Styles	7 1/2" to 25 7/8" (<3" wide rails/stiles) 8 1/2" to 25 7/8" (3" wide rails/stiles)	7 1/2" to 47 7/16" (<3" wide rails/stiles) 8 1/2" to 47 7/16" (3" wide rails/stiles)
	DADOORB and DADOORW	Non-Miter Square or Arch Styles	7 1/2" to 25 7/8" (<3" wide rails/stiles) 8 1/2" to 25 7/8" (3" wide rails/stiles)	47 1/2" to 72" (<3" wide rails/stiles) 47 1/2" to 72" (3" wide rails/stiles)
	DADOORB and DADOORW	Non-Miter Square Styles	25 15/16" to 35 3/4" (<3" wide rails/stiles) 25 15/16" to 35 3/4" (3" wide rails/stiles)	7 1/2" to 47 7/16" (<3" wide rails/stiles) 8 1/2" to 47 7/16" (3" wide rails/stiles)
	DADOORB and DADOORW	Non-Miter Square Styles	25 15/16" to 35 3/4" (<3" wide rails/stiles) 25 15/16" to 35 3/4" (3" wide rails/stiles)	47 1/2" to 72" (<3" wide rails/stiles) 47 1/2" to 72" (3" wide rails/stiles)
	DADOORB and DADOORW	Miter Styles	8" to 25 7/8"	8" to 61"
	DADOORHG	Non-Miter Square Styles	7 1/2" to 42 1/4" (<3" wide rails/stiles) 8 1/2" to 42 1/4" (3" wide rails/stiles)	7 1/2" to 23 3/4" (<3" wide rails/stiles) 8 1/2" to 23 3/4" (3" wide rails/stiles)
	DADOORHG	Miter Styles	8" to 61"	8" to 24"

\*Any door with a minimum width or height dimension less than 10" will receive a flat center panel.

# DECORATIVE APPLIANCE PANEL ORDER FORM

Use one order form per appliance.

Refer to Spec Book for door style availability, door style limitations and center panel configurations.

## STEP 1: Provide Order Information\*

Account #: \_\_\_\_\_  
 Date: \_\_\_\_\_  
 Bill To: \_\_\_\_\_

PO #: \_\_\_\_\_  
 Order #: \_\_\_\_\_  
 Ship To: \_\_\_\_\_

## STEP 2: Appliance Application or No Appliance\* — Circle Choice (For appliance applications, circle one appliance type below per order form)

Appliance Brand Name and Model Number \_\_\_\_\_

Refrigerator/Freezer

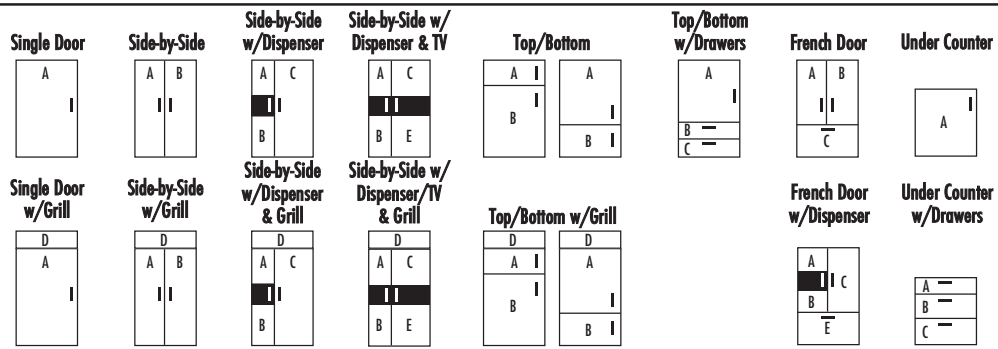

Dishwasher/Trash Compactor/  
Ice Maker/Wine Cooler

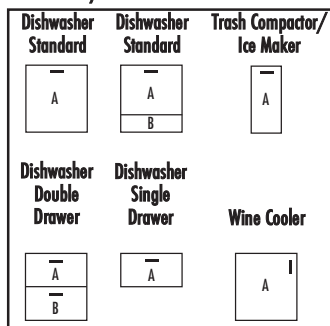

## STEP 3: Provide Dimensions in Inches for Panels and/or Doors Needed as Listed Above\*

Custom Panels — Dimensions for Custom Size Panel(s) and/or Door(s)

DAPNL1/4, DAPNL1/4P, DAPNL3/4, DAPNL3/4P, DAPNL1/4HGP, or DAPNL3/4HGP — Circle Choice

A \_\_\_\_\_ in. width x \_\_\_\_\_ in. height = \_\_\_\_\_ square inches  
 B \_\_\_\_\_ in. width x \_\_\_\_\_ in. height = \_\_\_\_\_ square inches  
 C \_\_\_\_\_ in. width x \_\_\_\_\_ in. height = \_\_\_\_\_ square inches  
 D \_\_\_\_\_ in. width x \_\_\_\_\_ in. height = \_\_\_\_\_ square inches  
 E \_\_\_\_\_ in. width x \_\_\_\_\_ in. height = \_\_\_\_\_ square inches

} total square inches

Standard or Custom Doors — Circle Choice

Standard Door Sizes — Dimensions for Panels with Standard Door Sizes (Chosen by Manufacturer)

\*Supply overall dimensions (width and height for each panel only). Doors will be selected by manufacturer to best fit panel dimensions.

DADOORB (Square Profile) and/or DADOORW (Arch Profile) and/or DADOORHG (Horizontal Grain, Square Profile) — Circle Door Choice Below For Each Door

DADOORB or DADOORW or DADOORHG \_\_\_\_\_ in. width x \_\_\_\_\_ in. height = \_\_\_\_\_ square inches  
 DADOORB or DADOORW or DADOORHG \_\_\_\_\_ in. width x \_\_\_\_\_ in. height = \_\_\_\_\_ square inches  
 DADOORB or DADOORW or DADOORHG \_\_\_\_\_ in. width x \_\_\_\_\_ in. height = \_\_\_\_\_ square inches  
 DADOORB or DADOORW or DADOORHG \_\_\_\_\_ in. width x \_\_\_\_\_ in. height = \_\_\_\_\_ square inches  
 DADOORB or DADOORW or DADOORHG \_\_\_\_\_ in. width x \_\_\_\_\_ in. height = \_\_\_\_\_ square inches

} total square inches

\*ALL FIELDS REQUIRED TO PROCESS ORDER.

**DESCRIPTION**  
**PANELS & SKINS**

**MODEL**

**END PANEL SKINS, BASE**

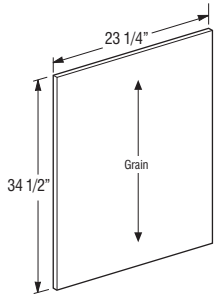

1/4" Finished

**BEPS34.5WD**

- Stains: 1/4" thick veneered furniture board.
- Paints: 1/4" thick veneered or solid furniture board.
- 1/4" (WD) skins recommended for use with PFINBTMB modification.

**Custom Modifications**

ID	RD
•	•

**Finish Techniques**

Distressing	Heirlooming

**Species Availability (Wood)**

Alder	Rustic Alder	Cherry	Hickory	Maple	Oak
•	Alder	•	•	•	•

**Species Availability (All Laminates)**

High Gloss box color	Horiz. Grain on Maple box color	Vert. Grain on Maple box color	Vert. Grain on Cherry box color	Vert. Grain on Hickory box color	Vert. Grain on Oak box color	Thermofoil box color
•						

**END PANEL SKINS, PREMIUM - BASE**

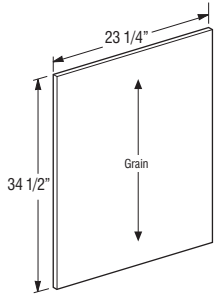

**BEPS34.5P**

- 1/4" thick laminated MDF.
- Not compatible with FPFB.
- High Gloss panels do not have grain.
- 1/4" skins recommended for use with PFINBTMB modification.

**Custom Modifications**

ID	RD
•	•

**Finish Techniques**

Distressing	Heirlooming

**Species Availability (Wood)**

Alder	Rustic Alder	Cherry	Hickory	Maple	Oak
•					

**Species Availability (All Laminates)**

High Gloss	Horiz. Grain on Maple	Vert. Grain on Maple	Vert. Grain on Cherry	Vert. Grain on Hickory	Vert. Grain on Oak	Thermofoil
•						

**DESCRIPTION**

**MODEL**

**END PANEL SKINS, TALL**



1/4" Finished

**TEPS1248WD**

**TEPS1296WD†**

**TEPS12102WD† ♦**

**TEPS12108WD† ♦**

**TEPS12120WD† ♦**

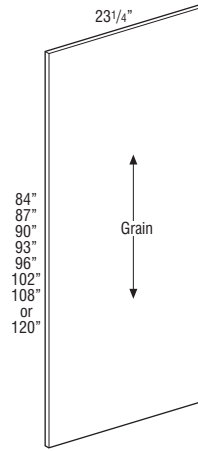
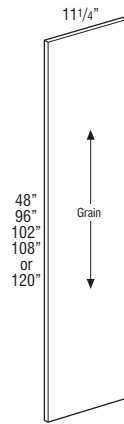

1/4" Finished

**TEPS84WD†**

**TEPS87WD†**

**TEPS90WD†**

**TEPS93WD†**

**TEPS96WD†**

**TEPS102WD† ♦**

**TEPS108WD† ♦**

**TEPS120WD† ♦**

- Stains: 1/4" thick veneered furniture board.
- Paints: 1/4" thick veneered or solid furniture board.
- 1/4" (WD) skins recommended for use with PFINBTMB modification.

†5 day Express Response not available on items greater than 48".

**Custom Modifications**

ID	RD
•	•

**Finish Techniques**

Distressing	Heirlooming

**Species Availability (Wood)**

Alder	Rustic Alder	Cherry	Hickory	Maple	Oak
•	Alder	•	•	•	•

♦ Only available in Cherry and Maple.

**Species Availability (All Laminates)**

High Gloss box color	Horiz. Grain on Maple box color	Vert. Grain on Maple box color	Vert. Grain on Cherry box color	Vert. Grain on Hickory box color	Vert. Grain on Oak box color	Thermofoil box color
•						

♦ Only available in Cherry and Maple box colors.

**DESCRIPTION**

**END PANEL SKINS, PREMIUM - TALL**

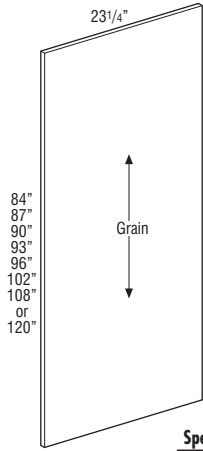
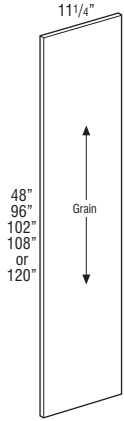

- TEPS1248P
- TEPS1296P†
- TEPS12102P†
- TEPS12108P†
- TEPS12120P†
- TEPS84P†
- TEPS87P†
- TEPS90P†
- TEPS93P†
- TEPS96P†
- TEPS102P†
- TEPS108P†
- TEPS120P†

- 1/4" thick laminated MDF.
- Not compatible with FPEB.
- High Gloss panels do not have grain.
- †5 day Express Response not available on items greater than 48"
- 1/4" skins recommended for use with PFINBTMB modification.

Custom Modifications		Finish Techniques	
ID	RD	Distressing	Heirlooming
•	•		

Species Availability (Wood)					
Alder	Rustic Alder	Cherry	Hickory	Maple	Oak

Species Availability (All Laminates)						
High Gloss	Horiz. Grain on Maple	Vert. Grain on Maple	Vert. Grain on Cherry	Vert. Grain on Hickory	Vert. Grain on Oak	Thermofoil
•		•	•	•	•	

**END PANEL SKINS, WALL**

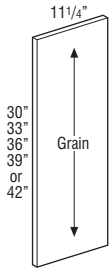

- 1/4" Finished
- WEPS30WD
- WEPS33WD
- WEPS36WD
- WEPS39WD
- WEPS42WD

- Stains: 1/4" thick veneered furniture board.
- Paints: 1/4" thick veneered or solid furniture board.
- Not compatible with Furniture Ends (FPEB).
- 1/4" (WD) skins recommended for use with PFINBTMB modification.

Custom Modifications		Finish Techniques	
ID	RD	Distressing	Heirlooming
•	•		

Species Availability (Wood)					
Alder	Rustic Alder	Cherry	Hickory	Maple	Oak
•		•	•	•	•

Species Availability (All Laminates)						
High Gloss box color	Horiz. Grain on Maple box color	Vert. Grain on Maple box color	Vert. Grain on Cherry box color	Vert. Grain on Hickory box color	Vert. Grain on Oak box color	Thermofoil box color

**DESCRIPTION**

**END PANEL SKINS, PREMIUM - WALL**

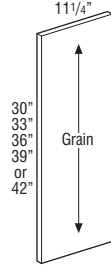

- WEPS30P
- WEPS33P
- WEPS36P
- WEPS39P
- WEPS42P

- 1/4" thick laminated MDF.
- Not compatible with FPEB.
- High Gloss panels do not have grain.
- 1/4" skins recommended for use with PFINBTMB modification.

Custom Modifications		Finish Techniques	
ID	RD	Distressing	Heirlooming
•	•		

Species Availability (Wood)					
Alder	Rustic Alder	Cherry	Hickory	Maple	Oak

Species Availability (All Laminates)						
High Gloss	Horiz. Grain on Maple	Vert. Grain on Maple	Vert. Grain on Cherry	Vert. Grain on Hickory	Vert. Grain on Oak	Thermofoil
•		•	•	•	•	

**FINISHED BACK SKINS**



- 1/4" Finished
- BP4830WD
- BP4834.5WD
- BP4840.5WD

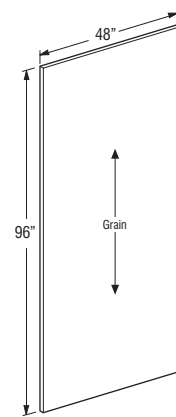
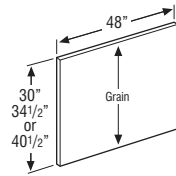

- 1/4" Finished
- BP4896WD†

- BP\_ \_WD in Stains: 1/4" thick veneered furniture board.
- BP\_ \_WD in Paints: 1/4" thick veneered or solid furniture board.
- For custom sizes refer to DAPNL 1/4.
- †5 day Express Response not available on items greater than 48".

Custom Modifications		Finish Techniques	
ID	RD	Distressing	Heirlooming

Species Availability (Wood)					
Alder	Rustic Alder	Cherry	Hickory	Maple	Oak
•	•	•	•	•	•

Species Availability (All Laminates)						
High Gloss box color	Horiz. Grain on Maple box color	Vert. Grain on Maple box color	Vert. Grain on Cherry box color	Vert. Grain on Hickory box color	Vert. Grain on Oak box color	Thermofoil box color

**BACK SKIN, INTERIOR**

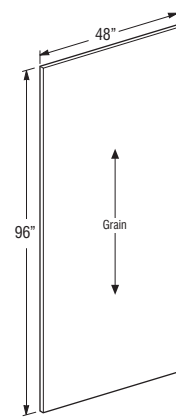

- 1/4" Natural Maple Laminate
- BP4896LAM

- 1/4" Clear Coated Veneer Plywood



- BP4896NIP

- BP4896LAM is 1/4" thick furniture board with Natural Maple laminate to match standard cabinet interior.
- BP4896NIP is 1/4" thick plywood with clear coated veneer to match APC cabinet interior.



**DESCRIPTION**

**MODEL**

**FINISHED BACK SKINS, PREMIUM**



**BP4830P**  
**BP4834.5P**  
**BP4840.5P**

**BP4896P†**

- 1/4" thick laminated MDF.
  - High Gloss panels do not have grain.
  - Not compatible with FPFB.
- †5 day Express Response not available on items greater than 48"

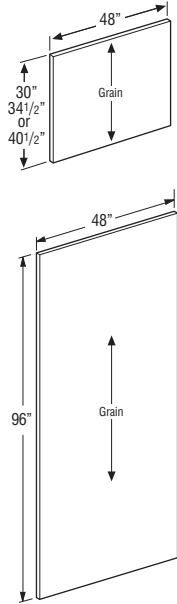

Custom Modifications		Finish Techniques	
ID	RD	Distressing	Heirlooming

Species Availability (Wood)					
Alder	Rustic Alder	Cherry	Hickory	Maple	Oak
•		•		•	•

Species Availability (All Laminates)						
High Gloss	Horiz. Grain on Maple	Vert. Grain on Maple	Vert. Grain on Cherry	Vert. Grain on Hickory	Vert. Grain on Oak	Thermofoil
box color		box color	box color	box color	box color	box color

**DESCRIPTION**

**MODEL**

**WOOD V-GROOVED BEADED SKIN 1/4" PANELS**



**BP4830VG**  
**BP4834.5VG**  
**BP4896VG†**

- BP48\_\_VG is a 1/4" thick veneered panel with an MDF core.
  - V-groove on 3" centers.
  - When used as a skin, not compatible in conjunction with Furniture Ends (FPFB) or Authentic Ends (AUTHL/AUTHR).
- †5 day Express Response not available on items greater than 48"

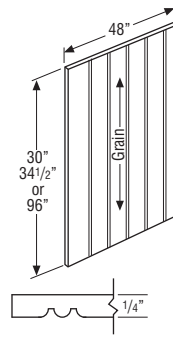

Custom Modifications		Finish Techniques	
ID	RD	Distressing	Heirlooming
			•

Species Availability (Wood)					
Alder	Rustic Alder	Cherry	Hickory	Maple	Oak
•		•	•	•	•

Species Availability (All Laminates)						
High Gloss	Horiz. Grain on Maple	Vert. Grain on Maple	Vert. Grain on Cherry	Vert. Grain on Hickory	Vert. Grain on Oak	Thermofoil
box color	box color	box color	box color	box color	box color	box color

**CROSS GRAIN VENEER BACK SKIN 1/4" PANELS**

**BP9634.5CRSGR**  
**BP9640.5CRSGR**  
**BP9648CRSGR**

- BP96\_\_CRSGR is a 1/4" thick veneered panel with an MDF core.
- When ordered in Paint finishes, panels will use vertical grain as grain will not be visible.

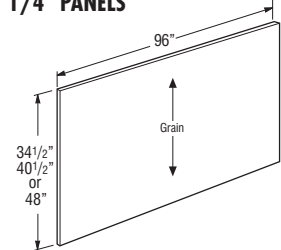

Custom Modifications		Finish Techniques	
ID	RD	Distressing	Heirlooming

Species Availability (Wood)					
Alder	Rustic Alder	Cherry	Hickory	Maple	Oak
•		•	•	•	•

Species Availability (All Laminates)						
High Gloss	Horiz. Grain on Maple	Vert. Grain on Maple	Vert. Grain on Cherry	Vert. Grain on Hickory	Vert. Grain on Oak	Thermofoil
box color	box color	box color	box color	box color	box color	box color

**HORIZONTAL GRAIN 1/4" SKIN, PREMIUM**



**14PANEL11.2530P**  
**14PANEL11.2548P**

**14PANEL2334.5P**

**14PANEL4830P**

**14PANEL4834.5P**

**14PANEL4848P**

**14PANEL9634.5P†**

**14PANEL9648P†**

- 1/4" thick laminated MDF.
  - Not compatible with FPFB.
- †5 day Express Response not available on items greater than 48"

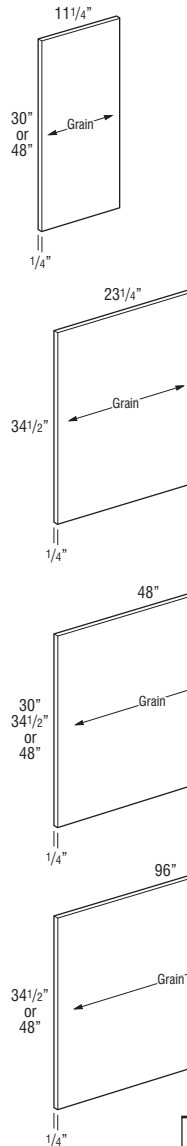

Custom Modifications		Finish Techniques	
ID	RD	Distressing	Heirlooming

Species Availability (Wood)					
Alder	Rustic Alder	Cherry	Hickory	Maple	Oak

Species Availability (All Laminates)						
High Gloss	Horiz. Grain on Maple	Vert. Grain on Maple	Vert. Grain on Cherry	Vert. Grain on Hickory	Vert. Grain on Oak	Thermofoil
	•					

**DESCRIPTION**

**HORIZONTAL GRAIN  
3/4" PANEL, PREMIUM**



**MODEL**  
34PANEL1230P

34PANEL1248P

34PANEL2434.5P

34PANEL4812P

34PANEL4834.5P

34PANEL4848P

34PANEL9612P†

34PANEL9624P†

34PANEL9630P†

- 3/4" thick laminated MDF.
  - Not compatible with FPEB.
  - 34PANEL4812P and 34PANEL9612P recommended for exterior shelf material.
  - Edgebanded on one short side and one long side only. Other edges will require moulding if exposed.
- †5 day Express Response not available on items greater than 48"

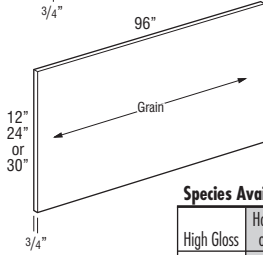
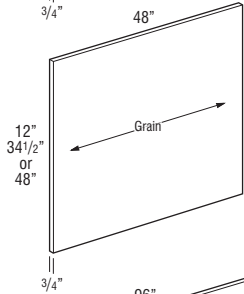
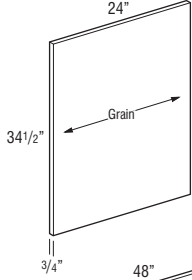
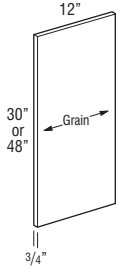

Custom Modifications				Finish Techniques	
ID	RD	APC	MIP	Distressing	Heirlooming

Species Availability (Wood)					
Alder	Rustic Alder	Cherry	Hickory	Maple	Oak
•	•	•	•	•	•

Species Availability (All Laminates)						
High Gloss	Horiz. Grain on Maple	Vert. Grain on Maple	Vert. Grain on Cherry	Vert. Grain on Hickory	Vert. Grain on Oak	Thermofoil
•						

**END PANELS, WALL**



**3/4" Finished**

**WEP1230WD**

**3/4" White Laminate**

**WEP1230LAM ♦**

- WEP1230WD in Stains: 3/4" thick veneered furniture board.
- WEP1230WD in Paints: 3/4" thick veneered or solid furniture board.
- WEP1230LAM is 3/4" thick laminated furniture board (white only).
- Panels are finished on two sides and front edge.

Custom Modifications				Finish Techniques	
ID	RD	APC	MIP	Distressing	Heirlooming
Laminate	•	•			
Wood	•	•			

Species Availability (Wood)					
Alder	Rustic Alder	Cherry	Hickory	Maple	Oak
•	•	•	•	•	•

♦ Only available in White laminate.

Species Availability (All Laminates)						
High Gloss	Horiz. Grain on Maple	Vert. Grain on Maple	Vert. Grain on Cherry	Vert. Grain on Hickory	Vert. Grain on Oak	Thermofoil
•						

♦ Only available in White laminate.

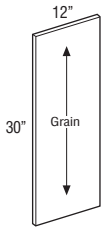

**DESCRIPTION**

**END PANELS,  
PREMIUM - WALL**



**WEP1230P**

- 3/4" thick laminated MDF.
- High Gloss panels will have high gloss on front of panel and back of panel will be white melamine.
- High Gloss panels do not have grain.
- Front of panel and edgebanding on front, top, and bottom of panel will match doors.

Custom Modifications				Finish Techniques	
ID	RD	APC	MIP	Distressing	Heirlooming
•	•				

Species Availability (Wood)					
Alder	Rustic Alder	Cherry	Hickory	Maple	Oak
•	•	•	•	•	•

Species Availability (All Laminates)						
High Gloss	Horiz. Grain on Maple	Vert. Grain on Maple	Vert. Grain on Cherry	Vert. Grain on Hickory	Vert. Grain on Oak	Thermofoil
•						

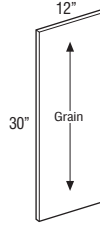

**END PANELS, BASE**



**3/4" Finished**

**BEPWD**

**3/4" White Laminate**

**BEPLAM ♦**

- BEPWD in Stains: 3/4" thick veneered furniture board.
- BEPWD in Paints: 3/4" thick veneered or solid furniture board.
- BEPLAM is 3/4" thick laminated furniture board (white only).
- Panels are finished on two sides and front edge.

Custom Modifications				Finish Techniques	
ID	RD	APC	MIP	Distressing	Heirlooming
Laminate	•	•			
Wood	•	•			

Species Availability (Wood)					
Alder	Rustic Alder	Cherry	Hickory	Maple	Oak
•	•	•	•	•	•

♦ Only available in White laminate.

Species Availability (All Laminates)						
High Gloss	Horiz. Grain on Maple	Vert. Grain on Maple	Vert. Grain on Cherry	Vert. Grain on Hickory	Vert. Grain on Oak	Thermofoil
•						

♦ Only available in White laminate.

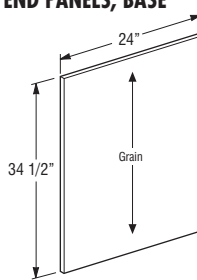

**END PANELS,  
PREMIUM - BASE**



**BEPP**

- 3/4" thick laminated MDF.
- High Gloss panels will have high gloss on front of panel and back of panel will be white melamine. Edgebanding on front edge will match door and drawer front edgebanding selection.
- High Gloss panels do not have grain.

Custom Modifications				Finish Techniques	
ID	RD	APC	MIP	Distressing	Heirlooming
•	•				

Species Availability (Wood)					
Alder	Rustic Alder	Cherry	Hickory	Maple	Oak
•	•	•	•	•	•

Species Availability (All Laminates)						
High Gloss	Horiz. Grain on Maple	Vert. Grain on Maple	Vert. Grain on Cherry	Vert. Grain on Hickory	Vert. Grain on Oak	Thermofoil
•						

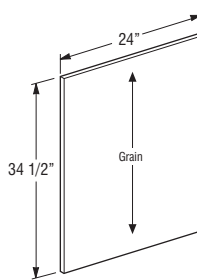

**DESCRIPTION**

**END PANELS, LAZY SUSAN**

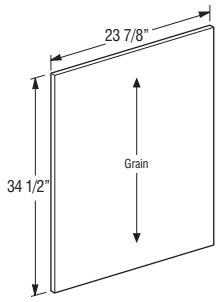

**MODEL**



1/2" Finished

**BLSBEPWD**

1/2" White Laminate

**BLSBEPLAM** ♦

- BLSBEPWD panels have veneer finished exterior and Natural Maple laminate interior. Specify MIP for veneered interior or APC for clear coated veneer.
- BLSBEPLAM panels have White laminated exterior and Natural Maple laminated interior.

**Custom Modifications**

	ID	RD	APC	MIP
Laminate	•	•		
Wood	•	•	•	•

**Finish Techniques**

Distressing	Heirlooming

**Species Availability (Wood)**

Alder	Rustic Alder	Cherry	Hickory	Maple	Oak
•	•		•	•	•

♦ Only available in White laminate.

**Species Availability (All Laminates)**

High Gloss box color	Horiz. Grain on Maple box color	Vert. Grain on Maple box color	Vert. Grain on Cherry box color	Vert. Grain on Hickory box color	Vert. Grain on Oak box color	Thermofoil box color

♦ Only available in White laminate.

**DESCRIPTION**

**END PANELS, TALL**

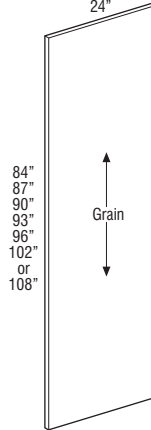
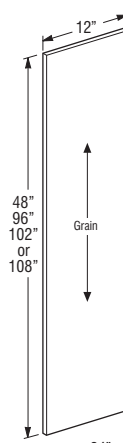

**MODEL**



3/4" Finished

**TEP1248WD**

**TEP1296WD**†

**TEP12102WD**† ♦♦

**TEP12108WD**† ♦♦

3/4" White Laminate

**TEP1248LAM** ♦

**TEP1296LAM**† ♦

3/4" Finished

**TEP2484WD**†♦

**TEP2487WD**†♦

**TEP2490WD**†♦

**TEP2493WD**†♦

**TEP2496WD**†♦

**TEP24102WD**† ♦♦

**TEP24108WD**† ♦♦

3/4" White Laminate

**TEP2484LAM**† ♦

**TEP2487LAM**† ♦

**TEP2490LAM**† ♦

**TEP2493LAM**† ♦

**TEP2496LAM**† ♦

- TEP\_ \_WD in Stains: 3/4" thick veneered furniture board.
  - TEP\_ \_WD in Paints: 3/4" thick veneered or solid furniture board.
  - TEP\_ \_LAM is 3/4" thick laminated furniture board (white only).
  - Panels are finished on two sides and front edge.
  - 102" and 108" will have APC and MIP standard.
- †5 day Express Response not available on items greater than 48".

**Custom Modifications**

	ID	RD	APC	MIP
Laminate	•	•		
Wood	•♦	•	•	•

**Finish Techniques**

Distressing	Heirlooming

♦Tall wood panels will be plywood when ID31-ID36 is specified.

**Species Availability (Wood)**

Alder	Rustic Alder	Cherry	Hickory	Maple	Oak
•	•	•	•	•	•

♦ Only available in White laminate.

♦♦ Only available in Cherry and Maple.

**Species Availability (All Laminates)**

High Gloss box color	Horiz. Grain on Maple box color	Vert. Grain on Maple box color	Vert. Grain on Cherry box color	Vert. Grain on Hickory box color	Vert. Grain on Oak box color	Thermofoil box color

♦ Only available in White laminate.

♦♦ Only available in Cherry and Maple box colors.

**DESCRIPTION**

**END PANELS, PREMIUM - TALL**

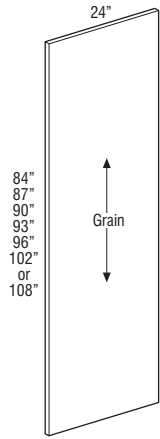
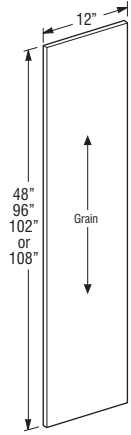

**MODEL**

TEP1248P

TEP1296P†

TEP12102P†

TEP12108P†

TEP2484P†

TEP2487P†

TEP2490P†

TEP2493P†

TEP2496P†

TEP24102P†

TEP24108P†

- 3/4" thick laminated MDF.
  - High Gloss panels will have high gloss on front of panel and back of panel will be white melamine. Edgebanding on front edge will match door and drawer front edgebanding selection.
  - High Gloss panels do not have grain.
- †5 day Express Response not available on items greater than 48"

**Custom Modifications**

ID	RD	APC	MIP
•*	•		

\*ID available on TEP2484P-TEP2496P up to 30".  
ID not available on TEP24102P and TEP24108P.

**Finish Techniques**

Distressing	Heirlooming

**Species Availability (Wood)**

Alder	Rustic Alder	Cherry	Hickory	Maple	Oak
•					

**Species Availability (All Laminates)**

High Gloss	Horiz. Grain on Maple	Vert. Grain on Maple	Vert. Grain on Cherry	Vert. Grain on Hickory	Vert. Grain on Oak	Thermofoil
•		•	•	•	•	

**END PANELS, VANITY**

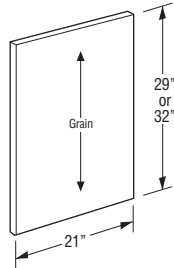

3/4" Finished

VBEP2129WD

VBEP2132WD

3/4" White Laminate

VBEP2129LAM ♦

VBEP2132LAM ♦

- VBEP\_\_WD in Stains: 3/4" thick veneered furniture board.
- VBEP\_\_WD in Paints: 3/4" thick veneered or solid furniture board.
- VBEP\_\_LAM is 3/4" thick laminated furniture board (white only).
- Panels are finished on two sides and front edge.

**Custom Modifications**

	ID	RD	APC	MIP
Laminate	•	•		
Wood	•	•	•	

**Finish Techniques**

Distressing	Heirlooming

**Species Availability (Wood)**

Alder	Rustic Alder	Cherry	Hickory	Maple	Oak
•		•	•	•	•

♦ Only available in White laminate.

**Species Availability (All Laminates)**

High Gloss	Horiz. Grain on Maple	Vert. Grain on Maple	Vert. Grain on Cherry	Vert. Grain on Hickory	Vert. Grain on Oak	Thermofoil
box color	box color	box color	box color	box color	box color	box color

♦ Only available in White laminate.

**DESCRIPTION**

**WALL PANEL with FILLER ATTACHED**

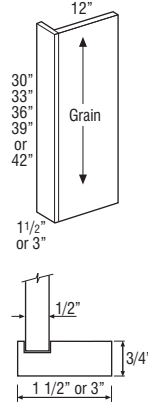

**MODEL**

1/2" Finished

WEP1230F1.5WD

WEP1230F3WD

WEP1233F1.5WD

WEP1233F3WD

WEP1236F1.5WD

WEP1236F3WD

WEP1239F1.5WD

WEP1239F3WD

WEP1242F1.5WD

WEP1242F3WD

1/2" White Laminate

WEP1230F1.5LAM ♦

WEP1230F3LAM ♦

WEP1233F1.5LAM ♦

WEP1233F3LAM ♦

WEP1236F1.5LAM ♦

WEP1236F3LAM ♦

WEP1239F1.5LAM ♦

WEP1239F3LAM ♦

WEP1242F1.5LAM ♦

WEP1242F3LAM ♦

- WEP\_\_F\_WD in Stains: 1/2" thick veneered furniture board.
- WEP\_\_F\_WD in Paints: 1/2" thick veneered or solid furniture board.
- WD panels have Natural Maple laminate interior. **Specify MIP for veneered interior or APC for clear coated veneer.**
- WEP\_\_F\_LAM is 1/2" thick laminated furniture board (White exterior with Natural Maple interior).

**Custom Modifications**

	ID	RD	APC	MIP	WLI
Laminate	•	•			•
Wood	•	•	•	•	•

**Finish Techniques**

Distressing	Heirlooming
•*	

\*Distressing on filler only, not on panel. Not available on laminate panels.

**Species Availability (Wood)**

Alder	Rustic Alder	Cherry	Hickory	Maple	Oak
•		•	•	•	•

♦ Only available in White laminate.

**Species Availability (All Laminates)**

High Gloss	Horiz. Grain on Maple	Vert. Grain on Maple	Vert. Grain on Cherry	Vert. Grain on Hickory	Vert. Grain on Oak	Thermofoil
box color	box color	box color	box color	box color	box color	box color

♦ Only available in White laminate.

**DESCRIPTION**

**BASE and TALL PANELS with FILLER ATTACHED**

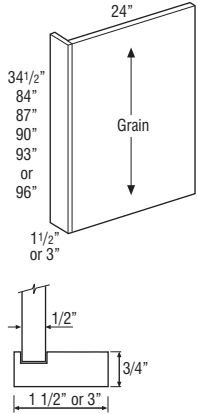

**MODEL**

- 1/2" Finished
- BEPF1.5WD**
- BEPF3WD**
- 1/2" White Laminate
- BEPF1.5LAM** ♦
- BEPF3LAM** ♦

- 1/2" Finished
- TEP2484F1.5WD**†
- TEP2484F3WD**†
- TEP2487F1.5WD**†
- TEP2487F3WD**†
- TEP2490F1.5WD**†
- TEP2490F3WD**†
- TEP2493F1.5WD**†
- TEP2493F3WD**†
- TEP2496F1.5WD**†
- TEP2496F3WD**†

- 1/2" White Laminate
- TEP2484F1.5LAM**† ♦
- TEP2484F3LAM**† ♦
- TEP2487F1.5LAM**† ♦
- TEP2487F3LAM**† ♦
- TEP2490F1.5LAM**† ♦
- TEP2490F3LAM**† ♦
- TEP2493F1.5LAM**† ♦
- TEP2493F3LAM**† ♦
- TEP2496F1.5LAM**† ♦
- TEP2496F3LAM**† ♦

- BEPF\_WD and TEP\_ \_F\_WD in Stains: 1/2" thick veneered furniture board.
- BEPF\_WD and TEP\_ \_F\_WD in Paints: 1/2" thick veneered or solid furniture board.
- WD panels have Natural Maple laminate interior. **Specify MIP for veneered interior or APC for clear coated veneer.**
- BEPF\_LAM and TEP\_ \_F\_LAM is 1/2" thick laminated furniture board (White exterior with Natural Maple interior).

†5 day Express Response not available on items greater than 48".

**Custom Modifications**

	ID	RD	APC	MIP	WLI
Laminate	•	•			•
Wood	•	•	•	•	•

**Finish Techniques**

	Distressing	Heirlooming
	•*	

\*Distressing on filler only, not on panel. Not available on laminate panels.

**Species Availability (Wood)**

	Alder	Rustic Alder	Cherry	Hickory	Maple	Oak
	•	Alder	•	•	•	•

♦ Only available in White laminate.

**Species Availability (All Laminates)**

High Gloss	Horiz. Grain on Maple	Vert. Grain on Maple	Vert. Grain on Cherry	Vert. Grain on Hickory	Vert. Grain on Oak	Thermofoil
box color	box color	box color	box color	box color	box color	box color

♦ Only available in White laminate.

**DESCRIPTION**

**WALL PANEL with FILLER ATTACHED and FURNITURE ENDS**

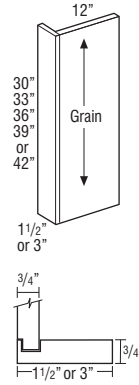

**MODEL**

- WEP1230F1.5FPE**
- WEP1230F3FPE**
- WEP1233F1.5FPE**
- WEP1233F3FPE**
- WEP1236F1.5FPE**
- WEP1236F3FPE**
- WEP1239F1.5FPE**
- WEP1239F3FPE**
- WEP1242F1.5FPE**
- WEP1242F3FPE**

- 3/4" thick veneered plywood.
- Panel will have veneered exterior and Natural Maple laminated interior standard. For veneered interior, specify MIP.

**Custom Modifications**

	ID	RD	APC	MIP
Wood	•	•		•

**Finish Techniques**

	Distressing	Heirlooming
	•	

**Species Availability (Wood)**

	Alder	Rustic Alder	Cherry	Hickory	Maple	Oak
	•	Alder	•	•	•	•

**Species Availability (All Laminates)**

High Gloss	Horiz. Grain on Maple	Vert. Grain on Maple	Vert. Grain on Cherry	Vert. Grain on Hickory	Vert. Grain on Oak	Thermofoil
box color	box color	box color	box color	box color	box color	box color

**BASE and TALL PANELS with FILLER ATTACHED and FURNITURE ENDS**

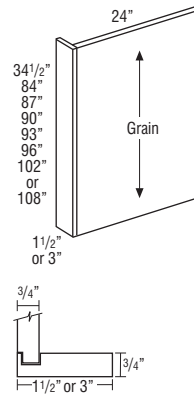

- BEPF1.5FPE**
- BEPF3FPE**

- TEP2484F1.5FPE**†
- TEP2484F3FPE**†
- TEP2487F1.5FPE**†
- TEP2487F3FPE**†
- TEP2490F1.5FPE**†
- TEP2490F3FPE**†
- TEP2493F1.5FPE**†
- TEP2493F3FPE**†
- TEP2496F1.5FPE**†
- TEP2496F3FPE**†
- TEP24102F1.5FPE**† ♦
- TEP24102F3FPE**† ♦
- TEP24108F1.5FPE**† ♦
- TEP24108F3FPE**† ♦

- 3/4" thick veneered plywood.
- Panel will have veneered exterior and Natural Maple laminated interior standard. For veneered interior, specify MIP.
- 102" and 108" are MIP standard.
- †5 day Express Response not available on items greater than 48".

**Custom Modifications**

	ID	RD	APC	MIP
Wood	•	•		•

**Finish Techniques**

	Distressing	Heirlooming
	•	

**Species Availability (Wood)**

	Alder	Rustic Alder	Cherry	Hickory	Maple	Oak
	•	Alder	•	•	•	•

♦ Only available in Cherry and Maple.

**Species Availability (All Laminates)**

High Gloss	Horiz. Grain on Maple	Vert. Grain on Maple	Vert. Grain on Cherry	Vert. Grain on Hickory	Vert. Grain on Oak	Thermofoil
box color	box color	box color	box color	box color	box color	box color

♦ Only available in Cherry and Maple box colors.

DESCRIPTION

WALL PANEL with FILLER ATTACHED and AUTHENTIC ENDS

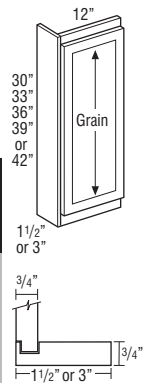

MODEL

- WEP1230F1.5AEL
- WEP1230F1.5AER
- WEP1230F3AEL
- WEP1230F3AER
- WEP1233F1.5AEL
- WEP1233F1.5AER
- WEP1233F3AEL
- WEP1233F3AER
- WEP1236F1.5AEL
- WEP1236F1.5AER
- WEP1236F3AEL
- WEP1236F3AER
- WEP1239F1.5AEL
- WEP1239F1.5AER
- WEP1239F3AEL
- WEP1239F3AER
- WEP1242F1.5AEL
- WEP1242F1.5AER
- WEP1242F3AEL
- WEP1242F3AER

- 3/4" thick veneered plywood with doors attached.
- Depth can be increased in 3" increments up to 24" deep.
- Panel will have veneered exterior and Natural Maple laminated interior standard. For veneered interior, specify MIP.
- Wixom doors will be high gloss and match edgebanding selection.
- Tranter doors will have horizontal grain with matching edgebanding.
- Graniti doors will have vertical grain with matching edgebanding.

Custom Modifications						Finish Techniques	
ID	RD	APC	MFO	MIP	Distressing	Heirlooming	
Wood	•	•	•	•	•	•	

Species Availability (Wood)						
Alder	Rustic Alder	Cherry	Hickory	Maple	Oak	
•	•	•	•	•	•	

Species Availability (All Laminates)						
High Gloss box color	Horiz. Grain on Maple box color	Vert. Grain on Maple box color	Vert. Grain on Cherry box color	Vert. Grain on Hickory box color	Vert. Grain on Oak box color	Thermofoil box color
•	•	•	•	•	•	•

DESCRIPTION

BASE PANEL with FILLER ATTACHED and AUTHENTIC ENDS

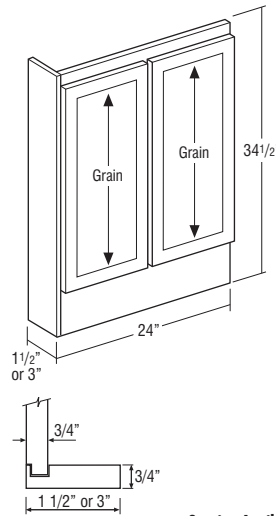

MODEL

- BEPF1.5AEL
- BEPF1.5AER
- BEPF3AEL
- BEPF3AER

- 3/4" thick veneered plywood with doors attached.
- Depth can be increased in 3" increments up to 36" deep.
- Panel will have veneered exterior and Natural Maple laminated interior standard. For veneered interior, specify MIP.
- Wixom doors will be high gloss and match edgebanding selection.
- Tranter doors will have horizontal grain with matching edgebanding.
- Graniti doors will have vertical grain with matching edgebanding.

Custom Modifications						Finish Techniques	
ID	RD	APC	MFO	MIP	Distressing	Heirlooming	
Wood	•	•	•	•	•	•	

Species Availability (Wood)					
Alder	Rustic Alder	Cherry	Hickory	Maple	Oak
•	•	•	•	•	•

Species Availability (All Laminates)						
High Gloss box color	Horiz. Grain on Maple box color	Vert. Grain on Maple box color	Vert. Grain on Cherry box color	Vert. Grain on Hickory box color	Vert. Grain on Oak box color	Thermofoil box color
•	•	•	•	•	•	•

BASE PANEL with FILLER ATTACHED and AUTHENTIC ENDS, SINGLE DOOR

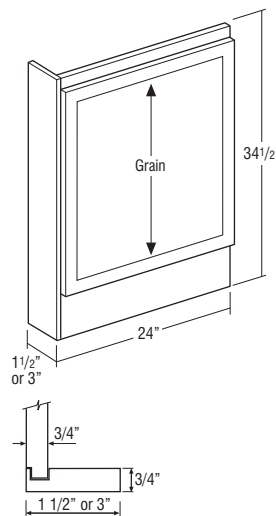

- BEPF1.5AELSD
- BEPF1.5AERSD
- BEPF3AELSD
- BEPF3AERSD

- 3/4" thick veneered plywood with doors attached.
- Depth can be reduced in 3" increments down to 9" deep.
- Panel will have veneered exterior and Natural Maple laminated interior standard. For veneered interior, specify MIP.
- Wixom doors will be high gloss and match edgebanding selection.
- Tranter doors will have horizontal grain with matching edgebanding.
- Graniti doors will have vertical grain with matching edgebanding.

Custom Modifications						Finish Techniques	
ID	RD	APC	MFO	MIP	Distressing	Heirlooming	
Wood	•	•	•	•	•	•	

Species Availability (Wood)					
Alder	Rustic Alder	Cherry	Hickory	Maple	Oak
•	•	•	•	•	•

Species Availability (All Laminates)						
High Gloss box color	Horiz. Grain on Maple box color	Vert. Grain on Maple box color	Vert. Grain on Cherry box color	Vert. Grain on Hickory box color	Vert. Grain on Oak box color	Thermofoil box color
•	•	•	•	•	•	•

**DESCRIPTION**

**MODEL**

**TALL PANEL with FILLER ATTACHED and AUTHENTIC ENDS**

- TEP2484F1.5AEL
- TEP2484F1.5AER
- TEP2484F3AEL
- TEP2484F3AER
- TEP2487F1.5AEL
- TEP2487F1.5AER
- TEP2487F3AEL
- TEP2487F3AER
- TEP2490F1.5AHAL
- TEP2490F1.5AHAR
- TEP2490F3AHAL
- TEP2490F3AHAR
- TEP2493F1.5AHAL
- TEP2493F1.5AHAR
- TEP2493F3AHAL
- TEP2493F3AHAR
- TEP2496F1.5AEL
- TEP2496F1.5AER
- TEP2496F3AEL
- TEP2496F3AER

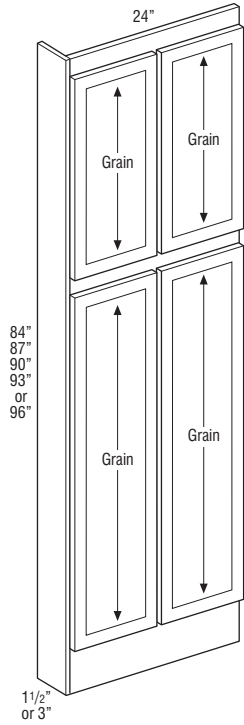

- AH represents upper section alignment with doors on 24" or 27" high cabinets.
- 3/4" thick veneered plywood with doors attached.
- Depth can be increased in 3" increments up to 36" deep.
- Panel will have veneered exterior and Natural Maple laminated interior standard. For veneered interior, specify MIP.
- Wixom doors will be high gloss and match edgebanding selection.
- Tranter doors will have horizontal grain with matching edgebanding.
- Graniti doors will have vertical grain with matching edgebanding.

**Custom Modifications**

	ID	RD	APC	MFO	MIP	INVFRM
Wood	•			•	•	•

**Finish Techniques**

	Distressing	Heirlooming
	•	•

**Species Availability (Wood)**

	Alder	Rustic Alder	Cherry	Hickory	Maple	Oak
	•	•	•	•	•	•

**Species Availability (All Laminates)**

	High Gloss	Horiz. Grain on Maple	Vert. Grain on Maple	Vert. Grain on Cherry	Vert. Grain on Hickory	Vert. Grain on Oak	Thermofoil
box color	box color	box color	box color	box color	box color	box color	box color

**DESCRIPTION**

**MODEL**

**TALL PANEL with FILLER ATTACHED and AUTHENTIC ENDS, SINGLE DOOR**

- TEP84F1.5AELSD
- TEP84F1.5AERSD
- TEP84F3AELSD
- TEP84F3AERSD
- TEP87F1.5AELSD
- TEP87F1.5AERSD
- TEP87F3AELSD
- TEP87F3AERSD
- TEP90F1.5AHALSD
- TEP90F1.5AHARSD
- TEP90F3AHALSD
- TEP90F3AHARSD
- TEP93F1.5AHALSD
- TEP93F1.5AHARSD
- TEP93F3AHALSD
- TEP93F3AHARSD
- TEP96F1.5AELSD
- TEP96F1.5AERSD
- TEP96F3AELSD
- TEP96F3AERSD

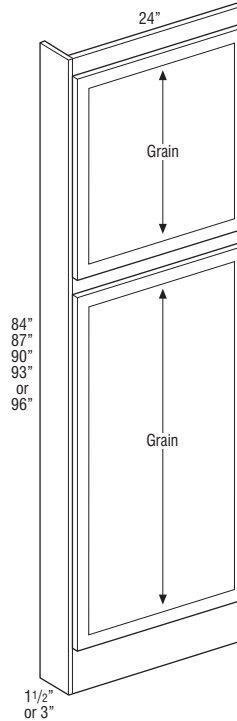

- AH represents upper section alignment with doors on 24" or 27" high cabinets.
- 3/4" thick veneered plywood with doors attached.
- Depth can be reduced in 3" increments down to 9" deep.
- On non-miter doors, the tall door on the bottom will have two vertical panels.
- Panel will have veneered exterior and Natural Maple laminated interior standard. For veneered interior, specify MIP.
- Wixom doors will be high gloss and match edgebanding selection.
- Tranter doors will have horizontal grain with matching edgebanding.
- Graniti doors will have vertical grain with matching edgebanding.

**Custom Modifications**

	ID	RD	APC	MFO	MIP	INVFRM
Wood	•			•	•	•

**Finish Techniques**

	Distressing	Heirlooming
	•	•

**Species Availability (Wood)**

	Alder	Rustic Alder	Cherry	Hickory	Maple	Oak
	•	•	•	•	•	•

**Species Availability (All Laminates)**

	High Gloss	Horiz. Grain on Maple	Vert. Grain on Maple	Vert. Grain on Cherry	Vert. Grain on Hickory	Vert. Grain on Oak	Thermofoil
box color	box color	box color	box color	box color	box color	box color	box color

**VANITY DESK LEGS**

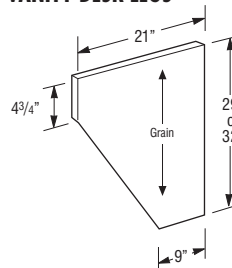

**VDL2129WD**

**VDL2132WD**

- All panels are finished 2 sides and front edge.
- VDL\_ \_WD in Stains: 3/4" thick veneered furniture board.
- VDL\_ \_WD in Paints: 3/4" thick veneered or solid furniture board.

**Custom Modifications**

	ID	RD

**Finish Techniques**

	Distressing	Heirlooming

**Species Availability (Wood)**

	Alder	Rustic Alder	Cherry	Hickory	Maple	Oak
	•	•	•	•	•	•

**Species Availability (All Laminates)**

	High Gloss	Horiz. Grain on Maple	Vert. Grain on Maple	Vert. Grain on Cherry	Vert. Grain on Hickory	Vert. Grain on Oak	Thermofoil
box color	box color	box color	box color	box color	box color	box color	box color

DESCRIPTION

MODEL

WOOD V-GROOVED with TRIPLE BEADED FRONT 3/4" PANELS

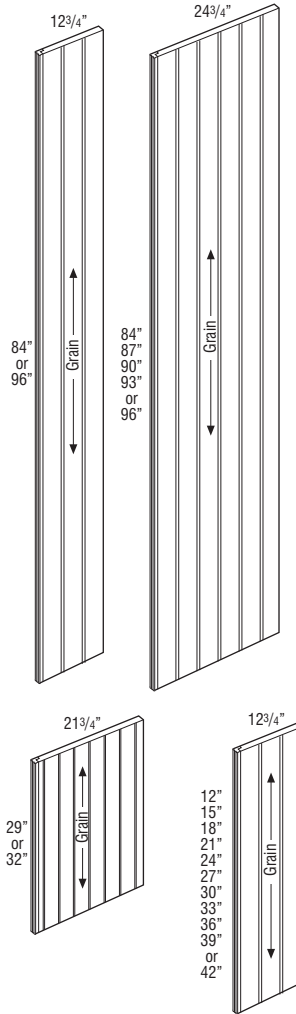

	Depth
BEPVG (34 1/2")	24 3/4"
BEPPVG (Peninsula)	25 1/2"
TEP1284VG†	12 3/4"
TEP1296VG†	12 3/4"
TEP84VG†	24 3/4"
TEP87VG†	24 3/4"
TEP90VG†	24 3/4"
TEP93VG†	24 3/4"
TEP96VG†	24 3/4"
VBEP29VG	21 3/4"
VBEP32VG	21 3/4"
WEP12VG	12 3/4"
WEP15VG	12 3/4"
WEP18VG	12 3/4"
WEP21VG	12 3/4"
WEP24VG	12 3/4"
WEP27VG	12 3/4"
WEP30VG	12 3/4"
WEP33VG	12 3/4"
WEP36VG	12 3/4"
WEP39VG	12 3/4"
WEP42VG	12 3/4"
WEPP42VG (Peninsula)	13 1/2"

- Veneer on MDF core.
  - V-groove on 3" centers.
- †5 day Express Response not available on items greater than 48".

Custom Modifications		Finish Techniques	
ID	RD	Distressing	Heirlooming
			•

Species Availability (Wood)					
Alder	Rustic Alder	Cherry	Hickory	Maple	Oak
•	•			•	

Species Availability (All Laminates)						
High Gloss	Horiz. Grain on Maple	Vert. Grain on Maple	Vert. Grain on Cherry	Vert. Grain on Hickory	Vert. Grain on Oak	Thermofoil
box color	box color	box color				box color

DESCRIPTION

MODEL

DECORATIVE DOOR PANEL KITS Base End



BED

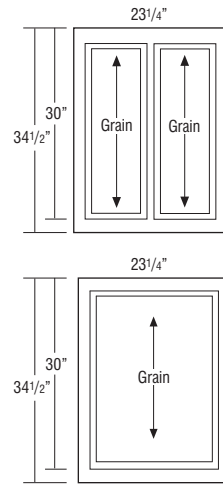

BEDSD

- Door panel kits include Base End Panel Skin and doors with attachment screws for field installation.
- Not compatible on cabinets specified with FPBE. Use Authentic Ends modification for decorative doors with FPBE.
- Wixom doors will be high gloss and match edgebanding selection.
- Tranter doors will have horizontal grain with matching edgebanding.
- Graniti doors will have vertical grain with matching edgebanding.

Custom Modifications			Finish Techniques	
ID	RD	MFO	Distressing	Heirlooming
			•	•

Species Availability (Wood)

Alder	Rustic Alder	Cherry	Hickory	Maple	Oak
•	•	•	•	•	•

Species Availability (All Laminates)

High Gloss	Horiz. Grain on Maple	Vert. Grain on Maple	Vert. Grain on Cherry	Vert. Grain on Hickory	Vert. Grain on Oak	Thermofoil
box color	box color	box color	box color	box color	box color	box color



**DESCRIPTION**

**MODEL**

**DECORATIVE DOOR  
PANEL KITS  
Tall End**

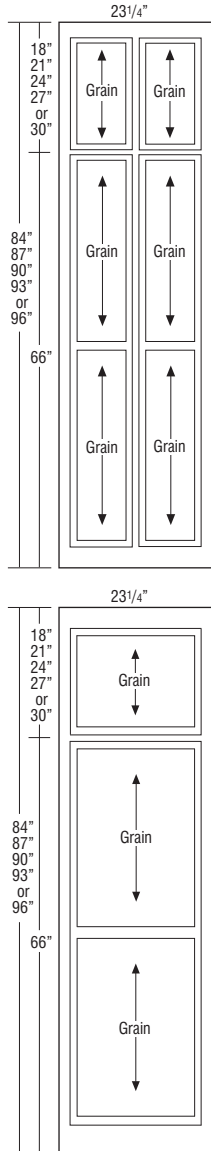

- TED2484
- TED2487
- TED2490AH
- TED2493AH
- TED2496

- TED2484SD
- TED2487SD
- TED2490SDAH
- TED2493SDAH
- TED2496SD

- AH represents upper section alignment with doors on 24" or 27" high cabinets.
- Door panel kits include Tall End Panel Skin and doors with attachment screws for field installation.
- Not compatible on cabinets specified with FPEB. Use Authentic Ends modification for decorative doors with FPEB.
- On non-miter doors, the tall door on the bottom will have two vertical panels.
- Wixom doors will be high gloss and match edgebanding selection.
- Tranter doors will have horizontal grain with matching edgebanding.
- Graniti doors will have vertical grain with matching edgebanding.

**Custom Modifications**

ID	RD	MFO
		•

**Finish Techniques**

Distressing	Heirlooming
•	•

**Species Availability (Wood)**

	Rustic Alder	Cherry	Hickory	Maple	Oak
•	•	•	•	•	•

**Species Availability (All Laminates)**

High Gloss	Horiz. Grain on Maple	Vert. Grain on Maple	Vert. Grain on Cherry	Vert. Grain on Hickory	Vert. Grain on Oak	Thermofoil
box color	box color	box color	box color	box color	box color	box color

**DESCRIPTION**

**MODEL**

**DECORATIVE DOOR  
PANEL KITS  
Wall End**

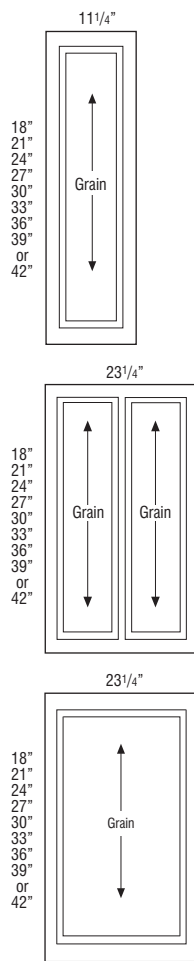

- WED1218
- WED1221
- WED1224
- WED1227
- WED1230
- WED1233
- WED1236
- WED1239
- WED1242
- WED2418
- WED2421
- WED2424
- WED2427
- WED2430
- WED2433
- WED2436
- WED2439
- WED2442

- WED2418SD
- WED2421SD
- WED2424SD
- WED2427SD
- WED2430SD
- WED2433SD
- WED2436SD
- WED2439SD
- WED2442SD

- Door panel kits include Wall End Panel Skin and doors with attachment screws for field installation.
- Custom door sizes not available.
- Not compatible on cabinets specified with FPEB. Use Authentic Ends modification for decorative doors with FPEB.
- Wixom doors will be high gloss and match edgebanding selection.
- Tranter doors will have horizontal grain with matching edgebanding.
- Graniti doors will have vertical grain with matching edgebanding.

**Custom Modifications**

ID	RD	MFO
		•

**Finish Techniques**

Distressing	Heirlooming
•	•

**Species Availability (Wood)**

Alder	Rustic Alder	Cherry	Hickory	Maple	Oak
•	•	•	•	•	•

**Species Availability (All Laminates)**

High Gloss	Horiz. Grain on Maple	Vert. Grain on Maple	Vert. Grain on Cherry	Vert. Grain on Hickory	Vert. Grain on Oak	Thermofoil
box color	box color	box color	box color	box color	box color	box color



## ARCHITECTURAL ACCENTS



All embellishments marked with the follow these guidelines:

### Program Details

- Products are shown with availability and exceptions noted.
- Items will be shipped loose for field attachment.

### Product Characteristics

- Natural characteristics of wood carved items are wider color range, irregularity of surface texture, and more noticeable variations in finish. It is imperative to understand the variations these characteristics entail and therefore will not be considered defective.

### Ordering Process

- To ensure product ships with the cabinet order, include on same order. Orders not placed together may not ship together.
  - Express Response program is available for 12 day delivery.
- Must specify wood species, finish, and technique, if different than the rest of the order.
- Since these items are ordered on an "as-required" basis, **no changes or cancellations will be accepted after 24 hours from acknowledgment of order.**

### MOULDING SPECIFICATIONS

Mouldings specified as 8' nominal length have a usable length range of 93" up to 99".  
Mouldings specified as 10' nominal length have a usable length range of 117" up to 123".  
Be sure to order the correct amount of moulding length to work around required cuts with minimal butt joints.

376

## DESCRIPTION

## CROWN MOULDING

### CLASSIC TALL CROWN



## MODEL

### CLTCROWN8

### CLTCROWN10 ♦

- CLTCROWN8 is one 8' section.
- CLTCROWN10 is one 10' section. 5 day Express Response not available.
- Cleat shipped unattached can be used for top mount or face frame applications.

### Finish Techniques

Distressing	Heirlooming
•	•

### Species Availability (Wood)

Alder	Rustic Alder	Cherry	Hickory	Maple	Oak
•	•	•	•	•	•

♦ Only available in Cherry and Maple.

### Species Availability (All Laminates)

High Gloss box color	Horiz. Grain on Maple box color	Vert. Grain on Maple box color	Vert. Grain on Cherry box color	Vert. Grain on Hickory box color	Vert. Grain on Oak box color	Thermofoil box color
----------------------	---------------------------------	--------------------------------	---------------------------------	----------------------------------	------------------------------	----------------------

♦ Only available in Cherry and Maple box colors.

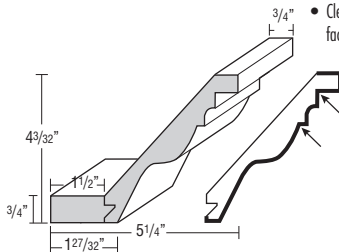

### CORNICE TALL CROWN



## MODEL

### COTCROWN8

### COTCROWN10 ♦

- COTCROWN8 is one 8' section.
- COTCROWN10 is one 10' section. 5 day Express Response not available.
- Cleat shipped unattached can be used for top mount or face frame applications.

### Finish Techniques

Distressing	Heirlooming
•	•

### Species Availability (Wood)

Alder	Rustic Alder	Cherry	Hickory	Maple	Oak
•	•	•	•	•	•

♦ Only available in Cherry and Maple.

### Species Availability (All Laminates)

High Gloss box color	Horiz. Grain on Maple box color	Vert. Grain on Maple box color	Vert. Grain on Cherry box color	Vert. Grain on Hickory box color	Vert. Grain on Oak box color	Thermofoil box color
----------------------	---------------------------------	--------------------------------	---------------------------------	----------------------------------	------------------------------	----------------------

♦ Only available in Cherry and Maple box colors.

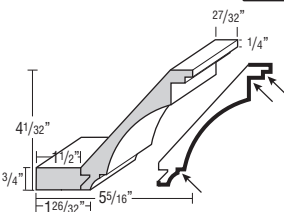

## DESCRIPTION

### COVE CROWN



## MODEL

### COVECROWN8

### COVECROWN10 ♦

- COVECROWN8 is one 8' section.
- COVECROWN10 is one 10' section. 5 day Express Response not available.
- Cleat shipped unattached can be used for top mount or face frame applications.

### Finish Techniques

Distressing	Heirlooming
•	•

### Species Availability (Wood)

Alder	Rustic Alder	Cherry	Hickory	Maple	Oak
•	•	•	•	•	•

♦ Only available in Cherry and Maple.

### Species Availability (All Laminates)

High Gloss box color	Horiz. Grain on Maple box color	Vert. Grain on Maple box color	Vert. Grain on Cherry box color	Vert. Grain on Hickory box color	Vert. Grain on Oak box color	Thermofoil box color
----------------------	---------------------------------	--------------------------------	---------------------------------	----------------------------------	------------------------------	----------------------

♦ Only available in Cherry and Maple box colors.

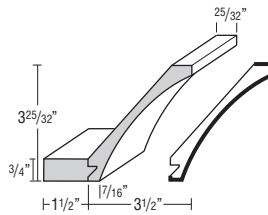

## DESCRIPTION

### FULL OVERLAY CROWN



## MODEL

### FOLCROWN8

- One 8' section.

### Finish Techniques

Distressing	Heirlooming
	•

### Species Availability (Wood)

Alder	Rustic Alder	Cherry	Hickory	Maple	Oak
•	•	•	•	•	•

### Species Availability (All Laminates)

High Gloss box color	Horiz. Grain on Maple box color	Vert. Grain on Maple box color	Vert. Grain on Cherry box color	Vert. Grain on Hickory box color	Vert. Grain on Oak box color	Thermofoil box color
----------------------	---------------------------------	--------------------------------	---------------------------------	----------------------------------	------------------------------	----------------------

♦ Only available in Cherry and Maple box colors.

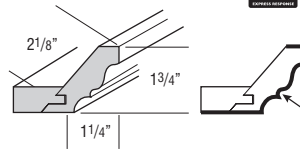

## DESCRIPTION

### INSERT CROWN



## MODEL

### INSCROWN8

- One 8' section.
- Designed for use with all 2 1/4" insert mouldings.

### Finish Techniques

Distressing	Heirlooming
	•

### Species Availability (Wood)

Alder	Rustic Alder	Cherry	Hickory	Maple	Oak
•	•	•	•	•	•

### Species Availability (All Laminates)

High Gloss box color	Horiz. Grain on Maple box color	Vert. Grain on Maple box color	Vert. Grain on Cherry box color	Vert. Grain on Hickory box color	Vert. Grain on Oak box color	Thermofoil box color
----------------------	---------------------------------	--------------------------------	---------------------------------	----------------------------------	------------------------------	----------------------

♦ Only available in Cherry and Maple box colors.

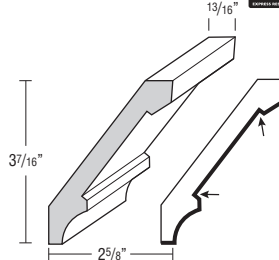

Finished edges indicated by bold lines on side view drawings.  
Glazed edges indicated by arrows on side view drawings.

**DESCRIPTION**

**MODEL**

**LARGE STRAIGHT ANGLE CROWN**



**LSACROWN8**

**LSACROWN10 ♦**

- LSACROWN8 is one 8' section.
- LSACROWN10 is one 10' section. 5 day Express Response not available.
- Cleat shipped unattached can be used for top mount or face frame applications.

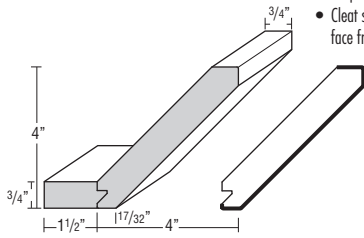

**Finish Techniques**

Distressing	Heirlooming
•	•

**Species Availability (Wood)**

Alder	Rustic Alder	Cherry	Hickory	Maple	Oak
•	•	•	•	•	•

♦ Only available in Cherry and Maple.

**Species Availability (All Laminates)**

High Gloss box color	Horiz. Grain on Maple box color	Vert. Grain on Maple box color	Vert. Grain on Cherry box color	Vert. Grain on Hickory box color	Vert. Grain on Oak box color	Thermofoil box color
•	•	•	•	•	•	•

♦ Only available in Cherry and Maple box colors.

**DESCRIPTION**

**MODEL**

**TALL CROWN**



**MTCROWN8**

**MTCROWN10 ♦**

- MTCROWN8 is one 8' section.
- MTCROWN10 is one 10' section. 5 day Express Response not available.

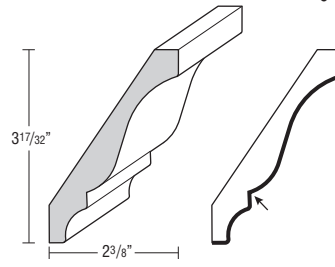

**Finish Techniques**

Distressing	Heirlooming
•	•

**Species Availability (Wood)**

Alder	Rustic Alder	Cherry	Hickory	Maple	Oak
•	•	•	•	•	•

♦ Only available in Cherry and Maple.

**Species Availability (All Laminates)**

High Gloss box color	Horiz. Grain on Maple box color	Vert. Grain on Maple box color	Vert. Grain on Cherry box color	Vert. Grain on Hickory box color	Vert. Grain on Oak box color	Thermofoil box color
•	•	•	•	•	•	•

♦ Only available in Cherry and Maple box colors.

**MEDIUM STRAIGHT ANGLE CROWN**



**MSACROWN8**

**MSACROWN10 ♦**

- MSACROWN8 is one 8' section.
- MSACROWN10 is one 10' section. 5 day Express Response not available.
- Cleat shipped unattached can be used for top mount or face frame applications.

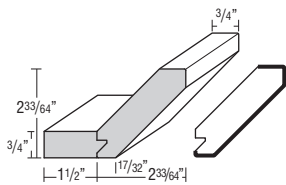

**Finish Techniques**

Distressing	Heirlooming
•	•

**Species Availability (Wood)**

Alder	Rustic Alder	Cherry	Hickory	Maple	Oak
•	•	•	•	•	•

♦ Only available in Cherry and Maple.

**Species Availability (All Laminates)**

High Gloss box color	Horiz. Grain on Maple box color	Vert. Grain on Maple box color	Vert. Grain on Cherry box color	Vert. Grain on Hickory box color	Vert. Grain on Oak box color	Thermofoil box color
•	•	•	•	•	•	•

♦ Only available in Cherry and Maple box colors.

**SHAKER CROWN**



**SHKRCRM8**

- Top mount moulding.
- One 8' section.

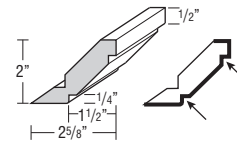

**Finish Techniques**

Distressing	Heirlooming
•	•

**Species Availability (Wood)**

Alder	Rustic Alder	Cherry	Hickory	Maple	Oak
•	•	•	•	•	•

**Species Availability (All Laminates)**

High Gloss box color	Horiz. Grain on Maple box color	Vert. Grain on Maple box color	Vert. Grain on Cherry box color	Vert. Grain on Hickory box color	Vert. Grain on Oak box color	Thermofoil box color
•	•	•	•	•	•	•

**STRAIGHT ANGLE CROWN**



**SACROWN8**

**SACROWN10 ♦**

- SACROWN8 is one 8' section.
- SACROWN10 is one 10' section. 5 day Express Response not available.
- Cleat shipped unattached can be used for top mount or face frame applications.

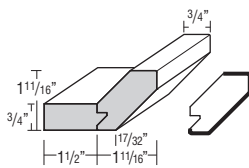

**Finish Techniques**

Distressing	Heirlooming
•	•

**Species Availability (Wood)**

Alder	Rustic Alder	Cherry	Hickory	Maple	Oak
•	•	•	•	•	•

♦ Only available in Cherry and Maple.

**Species Availability (All Laminates)**

High Gloss box color	Horiz. Grain on Maple box color	Vert. Grain on Maple box color	Vert. Grain on Cherry box color	Vert. Grain on Hickory box color	Vert. Grain on Oak box color	Thermofoil box color
•	•	•	•	•	•	•

♦ Only available in Cherry and Maple box colors.

**LARGE SHAKER CROWN**



**LSHAKER8**

**LSHAKER10 ♦**

- LSHAKER8 is one 8' section.
- LSHAKER10 is one 10' section. 5 day Express Response not available.

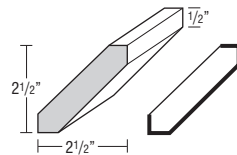

**Finish Techniques**

Distressing	Heirlooming
•	•

**Species Availability (Wood)**

Alder	Rustic Alder	Cherry	Hickory	Maple	Oak
•	•	•	•	•	•

♦ Only available in Cherry and Maple.

**Species Availability (All Laminates)**

High Gloss box color	Horiz. Grain on Maple box color	Vert. Grain on Maple box color	Vert. Grain on Cherry box color	Vert. Grain on Hickory box color	Vert. Grain on Oak box color	Thermofoil box color
•	•	•	•	•	•	•

♦ Only available in Cherry and Maple box colors.

Finished edges indicated by bold lines on side view drawings.  
Glazed edges indicated by arrows on side view drawings.

**DESCRIPTION**

**LARGE SHAKER CROWN, PREMIUM**

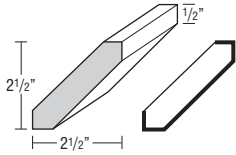

**MODEL**

**LSHAKER8P  
LSHAKER10P**

- LSHAKER8P is one 8" section.
- LSHAKER10P is one 10" section. 5 day Express Response not available.
- Horizontal grain except on High Gloss.

**Finish Techniques**

Distressing	Heirlooming

**Species Availability (Wood)**

Alder	Rustic Alder	Cherry	Hickory	Maple	Oak

**Species Availability (All Laminates)**

High Gloss	Horiz. Grain on Maple	Vert. Grain on Maple	Vert. Grain on Cherry	Vert. Grain on Hickory	Vert. Grain on Oak	Thermofoil
•	•	•	•	•	•	

**SMALL COVE CROWN MOULDING**

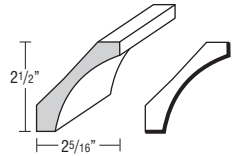

**SMCOVECROWN8**

**SMCOVECROWN10 ♦**

- SMCOVECROWN8 is one 8" section.
- SMCOVECROWN10 is one 10" section. 5 day Express Response not available.

**Finish Techniques**

Distressing	Heirlooming
•	•

**Species Availability (Wood)**

Alder	Rustic Alder	Cherry	Hickory	Maple	Oak
•	•	•	•	•	•

♦ Only available in Cherry and Maple.

**Species Availability (All Laminates)**

High Gloss	Horiz. Grain on Maple	Vert. Grain on Maple	Vert. Grain on Cherry	Vert. Grain on Hickory	Vert. Grain on Oak	Thermofoil
box color	box color	box color	box color	box color	box color	box color

♦ Only available in Cherry and Maple box colors.

**SMALL CROWN**



**SCM8**

**SCM10 ♦**

- Face mounts on Partial Overlay doors. May be face mounted on Full Overlay if used with a cleat.
- SCM8 is one 8" section.
- SCM10 is one 10" section. 5 day Express Response not available.
- Moulding can be used as standard or inverted.

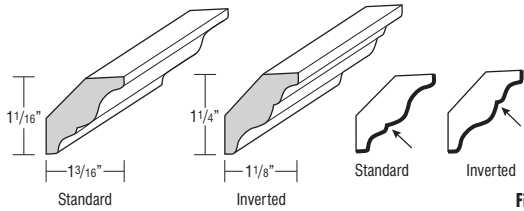

**Finish Techniques**

Distressing	Heirlooming
•	•

**Species Availability (Wood)**

Alder	Rustic Alder	Cherry	Hickory	Maple	Oak
•	•	•	•	•	•

♦ Only available in Cherry and Maple.

**Species Availability (All Laminates)**

High Gloss	Horiz. Grain on Maple	Vert. Grain on Maple	Vert. Grain on Cherry	Vert. Grain on Hickory	Vert. Grain on Oak	Thermofoil
box color	box color	box color	box color	box color	box color	box color

♦ Only available in Cherry and Maple box colors.

**DESCRIPTION**

**SOLID-WOOD CROWN**



**MODEL**

**SWCRM8  
SWCRM10 ♦**

- Face mounts on Partial Overlay doors. May be face mounted on Full Overlay if used with a cleat.
- SWCRM8 is one 8" section.
- SWCRM10 is one 10" section. 5 day Express Response not available.
- Moulding can be used as standard or inverted.

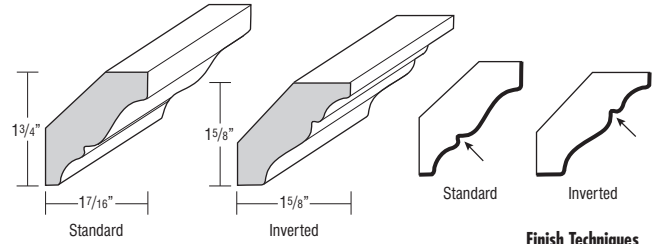

**Finish Techniques**

Distressing	Heirlooming
•	•

**Species Availability (Wood)**

Alder	Rustic Alder	Cherry	Hickory	Maple	Oak
•	•	•	•	•	•

♦ Only available in Cherry and Maple.

**Species Availability (All Laminates)**

High Gloss	Horiz. Grain on Maple	Vert. Grain on Maple	Vert. Grain on Cherry	Vert. Grain on Hickory	Vert. Grain on Oak	Thermofoil
box color	box color	box color	box color	box color	box color	box color

♦ Only available in Cherry and Maple box colors.

**SOLID-WOOD LARGE CROWN**



**SWLCRM8**

**SWLCRM10 ♦**

- Face mounts on Partial Overlay doors. May be face mounted on Full Overlay if used with a cleat.
- SWLCRM8 is one 8" section.
- SWLCRM10 is one 10" section. 5 day Express Response not available.
- Moulding can be used as standard or inverted.

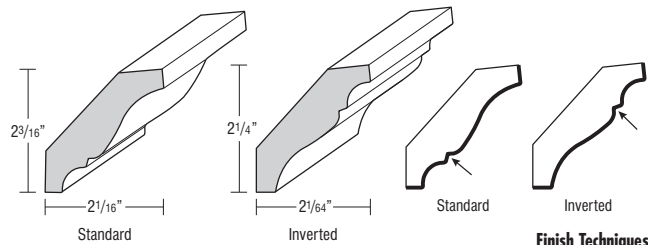

**Finish Techniques**

Distressing	Heirlooming
•	•

**Species Availability (Wood)**

Alder	Rustic Alder	Cherry	Hickory	Maple	Oak
•	•	•	•	•	•

♦ Only available in Cherry and Maple.

**Species Availability (All Laminates)**

High Gloss	Horiz. Grain on Maple	Vert. Grain on Maple	Vert. Grain on Cherry	Vert. Grain on Hickory	Vert. Grain on Oak	Thermofoil
box color	box color	box color	box color	box color	box color	box color

♦ Only available in Cherry and Maple box colors.

Finished edges indicated by bold lines on side view drawings.  
Glazed edges indicated by arrows on side view drawings.

**DESCRIPTION**

**MODEL**

**SOLID-WOOD TALL CROWN**



**SWTCRM8  
SWTCRM10 ♦**

- Face mounts on Partial Overlay doors. May be face mounted on Full Overlay if used with a cleat.
- SWTCRM8 is one 8" section.
- SWTCRM10 is one 10" section. 5 day Express Response not available.
- Moulding can be used as standard or inverted.

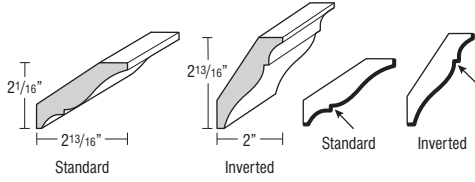

**Finish Techniques**

Distressing	Heirlooming
•	•

**Species Availability (Wood)**

Alder	Rustic Alder	Cherry	Hickory	Maple	Oak
•	•	•	•	•	•

♦ Only available in Cherry and Maple.

**Species Availability (All Laminates)**

High Gloss	Horiz. Grain on Maple	Vert. Grain on Maple	Vert. Grain on Cherry	Vert. Grain on Hickory	Vert. Grain on Oak	Thermofoil
box color	box color	box color	box color	box color	box color	box color

♦ Only available in Cherry and Maple box colors.

**SOLID-WOOD VICTORIAN CROWN**



**SWVCRM8  
SWVCRM10 ♦**

- Face mounts on Partial Overlay doors. May be face mounted on Full Overlay if used with a cleat.
- Designed for braided, dentil, egg & dart, or rope moulding application.
- SWVCRM8 is one 8" section.
- SWVCRM10 is one 10" section. 5 day Express Response not available.

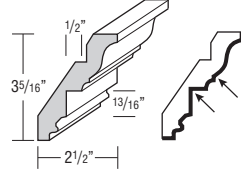

**Finish Techniques**

Distressing	Heirlooming
•	•

**Species Availability (Wood)**

Alder	Rustic Alder	Cherry	Hickory	Maple	Oak
•	•	•	•	•	•

♦ Only available in Cherry and Maple.

**Species Availability (All Laminates)**

High Gloss	Horiz. Grain on Maple	Vert. Grain on Maple	Vert. Grain on Cherry	Vert. Grain on Hickory	Vert. Grain on Oak	Thermofoil
box color	box color	box color	box color	box color	box color	box color

♦ Only available in Cherry and Maple box colors.

**DESCRIPTION**

**MODEL**

**STARTER MOULDINGS**

**SOFFIT FILLER MOULDING**



**SFM8  
SFM10 ♦**

- SFM8 is one 8" section.
- SFM10 is one 10" section. 5 day Express Response not available.
- Includes an unattached cleat.

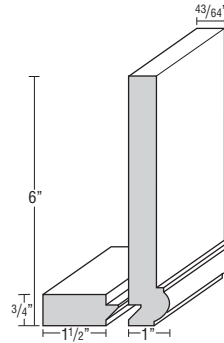

**Finish Techniques**

Distressing	Heirlooming
	•

**Species Availability (Wood)**

Alder	Rustic Alder	Cherry	Hickory	Maple	Oak
•	•	•	•	•	•

♦ Only available in Cherry and Maple.

**Species Availability (All Laminates)**

High Gloss	Horiz. Grain on Maple	Vert. Grain on Maple	Vert. Grain on Cherry	Vert. Grain on Hickory	Vert. Grain on Oak	Thermofoil
box color	box color	box color	box color	box color	box color	box color

♦ Only available in Cherry and Maple box colors.

**STARTER MOULDING**



**STR8  
STR10 ♦**

- STR8 is one 8" section.
- STR10 is one 10" section. 5 day Express Response not available.

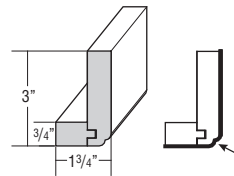

**Finish Techniques**

Distressing	Heirlooming
	•

**Species Availability (Wood)**

Alder	Rustic Alder	Cherry	Hickory	Maple	Oak
•	•	•	•	•	•

♦ Only available in Cherry and Maple.

**Species Availability (All Laminates)**

High Gloss	Horiz. Grain on Maple	Vert. Grain on Maple	Vert. Grain on Cherry	Vert. Grain on Hickory	Vert. Grain on Oak	Thermofoil
box color	box color	box color	box color	box color	box color	box color

♦ Only available in Cherry and Maple box colors.

**STARTER MOULDING, SHAKER**



**STRS8  
STRS10 ♦**

- STRS8 is one 8" section.
- STRS10 is one 10" section. 5 day Express Response not available.

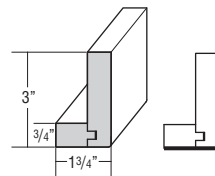

**Finish Techniques**

Distressing	Heirlooming
•	•

**Species Availability (Wood)**

Alder	Rustic Alder	Cherry	Hickory	Maple	Oak
•	•	•	•	•	•

♦ Only available in Cherry and Maple.

**Species Availability (All Laminates)**

High Gloss	Horiz. Grain on Maple	Vert. Grain on Maple	Vert. Grain on Cherry	Vert. Grain on Hickory	Vert. Grain on Oak	Thermofoil
box color	box color	box color	box color	box color	box color	box color

♦ Only available in Cherry and Maple box colors.

Finished edges indicated by bold lines on side view drawings.  
Glazed edges indicated by arrows on side view drawings.

DESCRIPTION

MODEL

**NEW** STARTER MOULDING, SHAKER PREMIUM



STRS8P

- One 8' section.
- Horizontal grain except on High Gloss.

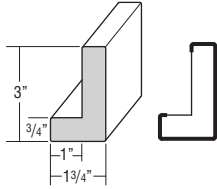

Finish Techniques

Distressing	Heirlooming

Species Availability (Wood)

Alder	Rustic Alder	Cherry	Hickory	Maple	Oak

Species Availability (All Laminates)

High Gloss	Horiz. Grain on Maple	Vert. Grain on Maple	Vert. Grain on Cherry	Vert. Grain on Hickory	Vert. Grain on Oak	Thermofoil
•	•	•	•	•	•	

MOULDING INSERTS

ACANTHUS INSERT



JACANINSERTM

- One 8' section.
- Pattern is 6" repeat.

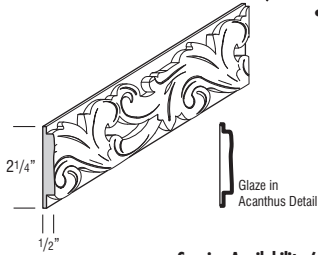

Finish Techniques

Distressing	Heirlooming
	•

Species Availability (Wood)

Alder	Rustic Alder	Cherry	Hickory	Maple	Oak
•	•	•		•	

Species Availability (All Laminates)

High Gloss	Horiz. Grain on Maple	Vert. Grain on Maple	Vert. Grain on Cherry	Vert. Grain on Hickory	Vert. Grain on Oak	Thermofoil
box color	box color	box color	box color			box color

BRAIDED



BRAIDM

- Designed to face mount on SWVCRM8.
- One 8' section.

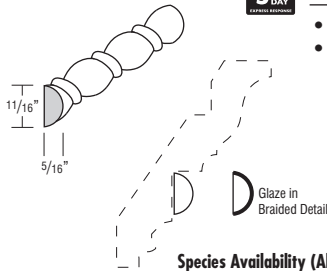

Finish Techniques

Distressing	Heirlooming

Species Availability (Wood)

Alder	Rustic Alder	Cherry	Hickory	Maple	Oak
•	•	•		•	Beech

Species Availability (All Laminates)

High Gloss	Horiz. Grain on Maple	Vert. Grain on Maple	Vert. Grain on Cherry	Vert. Grain on Hickory	Vert. Grain on Oak	Thermofoil
box color	box color	box color	box color	box color	box color	box color

CELTIC INSERT



INSERTCELT

- One 8' section.
- Designed to be used with Insert Crown.
- Pattern is 6" repeat.

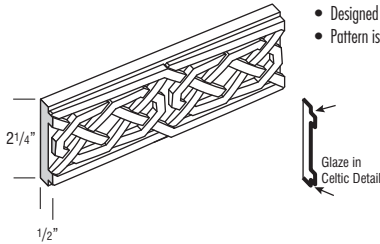

Finish Techniques

Distressing	Heirlooming
	•

Species Availability (Wood)

Alder	Rustic Alder	Cherry	Hickory	Maple	Oak
		•		•	

Species Availability (All Laminates)

High Gloss	Horiz. Grain on Maple	Vert. Grain on Maple	Vert. Grain on Cherry	Vert. Grain on Hickory	Vert. Grain on Oak	Thermofoil
box color	box color	box color	box color			box color

DESCRIPTION

MODEL

DENTIL



MDENTIL8

- Designed to face mount on SWVCRM8.
- One 8' section.

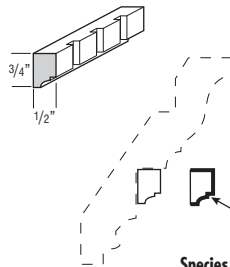

Finish Techniques

Distressing	Heirlooming

Species Availability (Wood)

Alder	Rustic Alder	Cherry	Hickory	Maple	Oak
•	•	•		•	•

Species Availability (All Laminates)

High Gloss	Horiz. Grain on Maple	Vert. Grain on Maple	Vert. Grain on Cherry	Vert. Grain on Hickory	Vert. Grain on Oak	Thermofoil
box color	box color	box color	box color		box color	box color

EGG & DART



EGD8

- Designed to face mount on SWVCRM8.
- One 8' section.

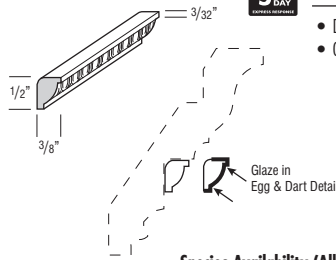

Finish Techniques

Distressing	Heirlooming

Species Availability (Wood)

Alder	Rustic Alder	Cherry	Hickory	Maple	Oak
				•	

Species Availability (All Laminates)

High Gloss	Horiz. Grain on Maple	Vert. Grain on Maple	Vert. Grain on Cherry	Vert. Grain on Hickory	Vert. Grain on Oak	Thermofoil
box color	box color	box color				box color

MISSION INSERT



JMISINSERTM

- One 8' section.
- Pattern is 6" repeat.

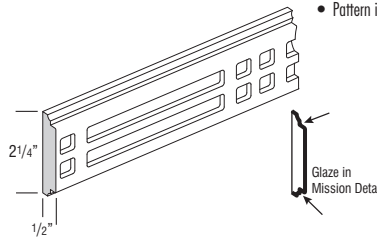

Finish Techniques

Distressing	Heirlooming
	•

Species Availability (Wood)

Alder	Rustic Alder	Cherry	Hickory	Maple	Oak
•	•	•		•	

Species Availability (All Laminates)

High Gloss	Horiz. Grain on Maple	Vert. Grain on Maple	Vert. Grain on Cherry	Vert. Grain on Hickory	Vert. Grain on Oak	Thermofoil
box color	box color	box color	box color			box color

ROPE



RPM8

- Designed to face mount on SWVCRM8.
- One 8' section.

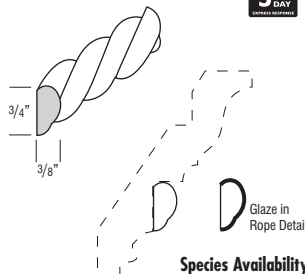

Finish Techniques

Distressing	Heirlooming

Species Availability (Wood)

Alder	Rustic Alder	Cherry	Hickory	Maple	Oak
•	•	•	•	•	•

Species Availability (All Laminates)

High Gloss	Horiz. Grain on Maple	Vert. Grain on Maple	Vert. Grain on Cherry	Vert. Grain on Hickory	Vert. Grain on Oak	Thermofoil
box color	box color	box color	box color	box color	box color	box color

Finished edges indicated by bold lines on side view drawings.  
Glazed edges indicated by arrows on side view drawings.



**DESCRIPTION**

**MODEL**

**WEAVE INSERT**

**JWEAVEINSERTM**

- One 8" section.
- Pattern is 6" repeat.

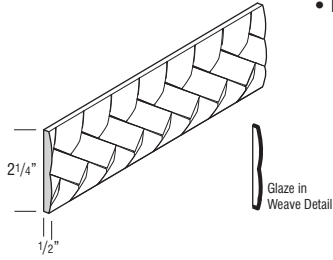

**Finish Techniques**

Distressing	Heirloom
	•

**Species Availability (Wood)**

Alder	Rustic Alder	Cherry	Hickory	Maple	Oak
•	Alder	•		•	

**Species Availability (All Laminates)**

High Gloss box color	Horiz. Grain on Maple box color	Vert. Grain on Maple box color	Vert. Grain on Cherry box color	Vert. Grain on Hickory	Vert. Grain on Oak	Thermofoil box color
----------------------	---------------------------------	--------------------------------	---------------------------------	------------------------	--------------------	----------------------

**ACCENT MOULDING**

**ACANTHUS**

**ACAM**

- One 8" section.

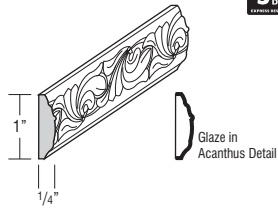

**Finish Techniques**

Distressing	Heirloom

**Species Availability (Wood)**

Alder	Rustic Alder	Cherry	Hickory	Maple	Oak
•	Alder	•	Beech	•	Beech

**Species Availability (All Laminates)**

High Gloss box color	Horiz. Grain on Maple box color	Vert. Grain on Maple box color	Vert. Grain on Cherry box color	Vert. Grain on Hickory	Vert. Grain on Oak	Thermofoil box color
----------------------	---------------------------------	--------------------------------	---------------------------------	------------------------	--------------------	----------------------

**BACK PANEL MOULDING**

**BPM8**

- One 8" section.
- Designed to provide a decorative edge between cabinet and panel-corner seam.

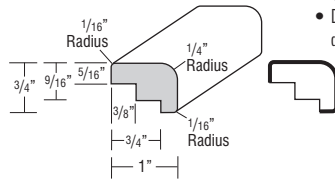

**Finish Techniques**

Distressing	Heirloom

**Species Availability (Wood)**

Alder	Rustic Alder	Cherry	Hickory	Maple	Oak
•	Alder	•	•	•	•

**Species Availability (All Laminates)**

High Gloss box color	Horiz. Grain on Maple box color	Vert. Grain on Maple box color	Vert. Grain on Cherry box color	Vert. Grain on Hickory box color	Vert. Grain on Oak box color	Thermofoil box color
----------------------	---------------------------------	--------------------------------	---------------------------------	----------------------------------	------------------------------	----------------------

**CABINET PANEL EDGE**

**CPE8**

- One 8" section.

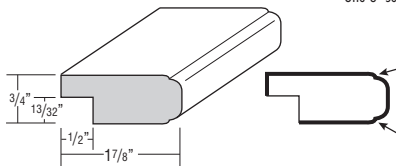

**Finish Techniques**

Distressing	Heirloom
	•

**Species Availability (Wood)**

Alder	Rustic Alder	Cherry	Hickory	Maple	Oak
•	Alder	•	•	•	•

**Species Availability (All Laminates)**

High Gloss box color	Horiz. Grain on Maple box color	Vert. Grain on Maple box color	Vert. Grain on Cherry box color	Vert. Grain on Hickory box color	Vert. Grain on Oak box color	Thermofoil box color
----------------------	---------------------------------	--------------------------------	---------------------------------	----------------------------------	------------------------------	----------------------

**DESCRIPTION**

**MODEL**

**COUNTERTOP EDGE**



**CCM8**

**Contemporary**

**Traditional**

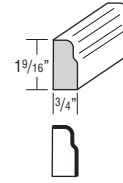
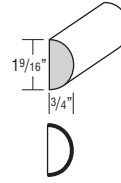

**TCM8**

- One 8" section.

**Finish Techniques**

Distressing	Heirloom
	•*

\*Available on TCM8 only

**Species Availability (Wood)**

Alder	Rustic Alder	Cherry	Hickory	Maple	Oak
•	Alder	•	•	•	•

**Species Availability (All Laminates)**

High Gloss box color	Horiz. Grain on Maple box color	Vert. Grain on Maple box color	Vert. Grain on Cherry box color	Vert. Grain on Hickory box color	Vert. Grain on Oak box color	Thermofoil box color
----------------------	---------------------------------	--------------------------------	---------------------------------	----------------------------------	------------------------------	----------------------

**FLAT SCRIBE**



**SM8**

**SM10 ♦**

- SM8 is one 8" section.
- SM10 is one 10" section. 5 day Express Response not available.

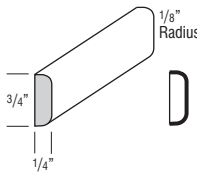

**Finish Techniques**

Distressing	Heirloom

**Species Availability (Wood)**

Alder	Rustic Alder	Cherry	Hickory	Maple	Oak
•	Alder	•	•	•	•

♦ Only available in Cherry and Maple.

**Species Availability (All Laminates)**

High Gloss box color	Horiz. Grain on Maple box color	Vert. Grain on Maple box color	Vert. Grain on Cherry box color	Vert. Grain on Hickory box color	Vert. Grain on Oak box color	Thermofoil box color
----------------------	---------------------------------	--------------------------------	---------------------------------	----------------------------------	------------------------------	----------------------

♦ Only available in Cherry and Maple box colors.

**FLAT SCRIBE, PREMIUM**



**SM8P**

**SM10P**

- SM8P is one 8" section.
- SM10P is one 10" section. 5 day Express Response not available.
- Horizontal grain except on High Gloss.

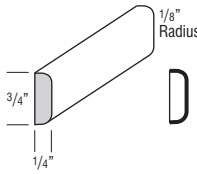

**Finish Techniques**

Distressing	Heirloom

**Species Availability (Wood)**

Alder	Rustic Alder	Cherry	Hickory	Maple	Oak

**Species Availability (All Laminates)**

High Gloss	Horiz. Grain on Maple	Vert. Grain on Maple	Vert. Grain on Cherry	Vert. Grain on Hickory	Vert. Grain on Oak	Thermofoil
•	•	•	•	•	•	

Finished edges indicated by bold lines on side view drawings.  
Glazed edges indicated by arrows on side view drawings.

DESCRIPTION

MODEL

LIBRARY MOULDING



LBRM

- One 8' section.

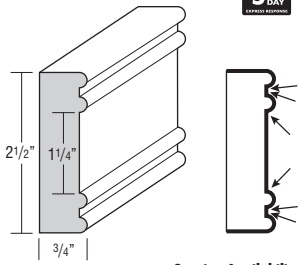

Finish Techniques

Distressing	Heirlooming
•	•

Species Availability (Wood)

Alder	Rustic Alder	Cherry	Hickory	Maple	Oak
•	•	•	•	•	•

Species Availability (All Laminates)

High Gloss box color	Horiz. Grain on Maple box color	Vert. Grain on Maple box color	Vert. Grain on Cherry box color	Vert. Grain on Hickory box color	Vert. Grain on Oak box color	Thermofoil box color
----------------------	---------------------------------	--------------------------------	---------------------------------	----------------------------------	------------------------------	----------------------

MIRROR FRAME



WMF8

- Pre-grooved.
- One 8' section.

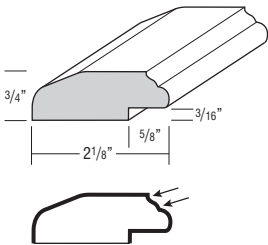

Finish Techniques

Distressing	Heirlooming
•	•

Species Availability (Wood)

Alder	Rustic Alder	Cherry	Hickory	Maple	Oak
•	•	•	•	•	•

Species Availability (All Laminates)

High Gloss box color	Horiz. Grain on Maple box color	Vert. Grain on Maple box color	Vert. Grain on Cherry box color	Vert. Grain on Hickory box color	Vert. Grain on Oak box color	Thermofoil box color
----------------------	---------------------------------	--------------------------------	---------------------------------	----------------------------------	------------------------------	----------------------

OGEE EDGE



OGEE8

- One 8' section.

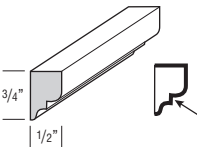

Finish Techniques

Distressing	Heirlooming
•	•

Species Availability (Wood)

Alder	Rustic Alder	Cherry	Hickory	Maple	Oak
•	•	•	•	•	•

Species Availability (All Laminates)

High Gloss box color	Horiz. Grain on Maple box color	Vert. Grain on Maple box color	Vert. Grain on Cherry box color	Vert. Grain on Hickory box color	Vert. Grain on Oak box color	Thermofoil box color
----------------------	---------------------------------	--------------------------------	---------------------------------	----------------------------------	------------------------------	----------------------

SINGLE BEAD EDGE



SBE8

- One 8' section.

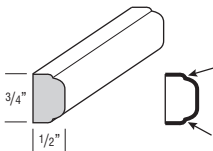

Finish Techniques

Distressing	Heirlooming
•	•

Species Availability (Wood)

Alder	Rustic Alder	Cherry	Hickory	Maple	Oak
•	•	•	•	•	•

Species Availability (All Laminates)

High Gloss box color	Horiz. Grain on Maple box color	Vert. Grain on Maple box color	Vert. Grain on Cherry box color	Vert. Grain on Hickory box color	Vert. Grain on Oak box color	Thermofoil box color
----------------------	---------------------------------	--------------------------------	---------------------------------	----------------------------------	------------------------------	----------------------

DESCRIPTION

MODEL

SINGLE BEAD MOULDING



SBM8

- One 8' section.

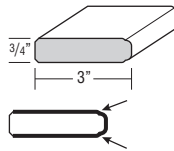

Finish Techniques

Distressing	Heirlooming
•	•

Species Availability (Wood)

Alder	Rustic Alder	Cherry	Hickory	Maple	Oak
•	•	•	•	•	•

Species Availability (All Laminates)

High Gloss box color	Horiz. Grain on Maple box color	Vert. Grain on Maple box color	Vert. Grain on Cherry box color	Vert. Grain on Hickory box color	Vert. Grain on Oak box color	Thermofoil box color
----------------------	---------------------------------	--------------------------------	---------------------------------	----------------------------------	------------------------------	----------------------

SINGLE BEAD PILASTER



SBP8

- One 8' section.
- Can be used vertically between cabinets for an inset look.

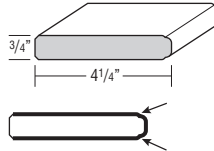

Finish Techniques

Distressing	Heirlooming
•	•

Species Availability (Wood)

Alder	Rustic Alder	Cherry	Hickory	Maple	Oak
•	•	•	•	•	•

Species Availability (All Laminates)

High Gloss box color	Horiz. Grain on Maple box color	Vert. Grain on Maple box color	Vert. Grain on Cherry box color	Vert. Grain on Hickory box color	Vert. Grain on Oak box color	Thermofoil box color
----------------------	---------------------------------	--------------------------------	---------------------------------	----------------------------------	------------------------------	----------------------

SMALL SCRIBE



SSM8

SSM10 ♦

- SSM8 is one 8' section.
- SSM10 is one 10' section. 5 day Express Response not available.

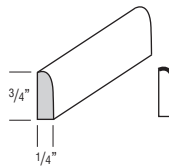

Finish Techniques

Distressing	Heirlooming
•	•

Species Availability (Wood)

Alder	Rustic Alder	Cherry	Hickory	Maple	Oak
•	•	•	•	•	•

♦ Only available in Cherry and Maple.

Species Availability (All Laminates)

High Gloss box color	Horiz. Grain on Maple box color	Vert. Grain on Maple box color	Vert. Grain on Cherry box color	Vert. Grain on Hickory box color	Vert. Grain on Oak box color	Thermofoil box color
----------------------	---------------------------------	--------------------------------	---------------------------------	----------------------------------	------------------------------	----------------------

♦ Only available in Cherry and Maple box colors.

SMALL SCRIBE, PREMIUM



SSM8P

SSM10P

- SSM8P is one 8' section.
- SSM10P is one 10' section. 5 day Express Response not available.
- Horizontal grain except on High Gloss.

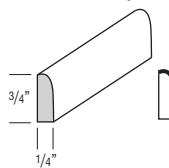

Finish Techniques

Distressing	Heirlooming
•	•

Species Availability (Wood)

Alder	Rustic Alder	Cherry	Hickory	Maple	Oak
•	•	•	•	•	•

Species Availability (All Laminates)

High Gloss	Horiz. Grain on Maple	Vert. Grain on Maple	Vert. Grain on Cherry	Vert. Grain on Hickory	Vert. Grain on Oak	Thermofoil
•	•	•	•	•	•	•

Finished edges indicated by bold lines on side view drawings.  
Glazed edges indicated by arrows on side view drawings.



**DESCRIPTION**

**MODEL**

**SOFFIT TRIM MOULDING**



**TSTM8**  
**TSTM10** ♦

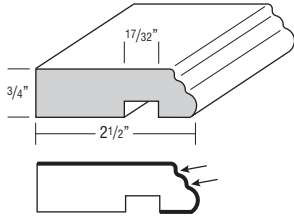

- TSTM8 is one 8' section.
- TSTM10 is one 10' section. 5 day Express Response not available.

**Finish Techniques**

Distressing	Heirloom

**Species Availability (Wood)**

Alder	Rustic Alder	Cherry	Hickory	Maple	Oak
•	•	•	•	•	•

♦ Only available in Cherry and Maple.

**Species Availability (All Laminates)**

High Gloss box color	Horiz. Grain on Maple box color	Vert. Grain on Maple box color	Vert. Grain on Cherry box color	Vert. Grain on Hickory box color	Vert. Grain on Oak box color	Thermofoil box color
----------------------	---------------------------------	--------------------------------	---------------------------------	----------------------------------	------------------------------	----------------------

♦ Only available in Cherry and Maple box colors.

**TRIPLE BEAD EDGE**



**TBEM**

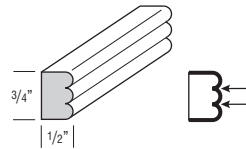

- One 8' section.

**Finish Techniques**

Distressing	Heirloom
	•

**Species Availability (Wood)**

Alder	Rustic Alder	Cherry	Hickory	Maple	Oak
•	•	•	•	•	•

**Species Availability (All Laminates)**

High Gloss box color	Horiz. Grain on Maple box color	Vert. Grain on Maple box color	Vert. Grain on Cherry box color	Vert. Grain on Hickory box color	Vert. Grain on Oak box color	Thermofoil box color
----------------------	---------------------------------	--------------------------------	---------------------------------	----------------------------------	------------------------------	----------------------

**TRIPLE BEAD PILASTER**



**TBP8**

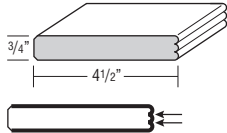

- Finished beaded front and two 4 1/2" sides.
- Can be used vertically between cabinets for an inset look.
- One 8' section.

**Finish Techniques**

Distressing	Heirloom
	•

**Species Availability (Wood)**

Alder	Rustic Alder	Cherry	Hickory	Maple	Oak
•	•	•	•	•	•

**Species Availability (All Laminates)**

High Gloss box color	Horiz. Grain on Maple box color	Vert. Grain on Maple box color	Vert. Grain on Cherry box color	Vert. Grain on Hickory box color	Vert. Grain on Oak box color	Thermofoil box color
----------------------	---------------------------------	--------------------------------	---------------------------------	----------------------------------	------------------------------	----------------------

**WIDE SCRIBE**



**WSCRIBE**

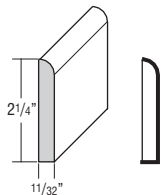

- One 8' section.

**Finish Techniques**

Distressing	Heirloom
	•

**Species Availability (Wood)**

Alder	Rustic Alder	Cherry	Hickory	Maple	Oak
•	•	•	•	•	•

**Species Availability (All Laminates)**

High Gloss box color	Horiz. Grain on Maple box color	Vert. Grain on Maple box color	Vert. Grain on Cherry box color	Vert. Grain on Hickory box color	Vert. Grain on Oak box color	Thermofoil box color
----------------------	---------------------------------	--------------------------------	---------------------------------	----------------------------------	------------------------------	----------------------

**DESCRIPTION**

**MODEL**

**NEW UNDER PANEL MOULDING**



**UPM8**

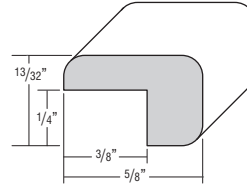

- One 8' section.
- Can be used on edges of 1/4" thick panels to conceal end grain.

**Finish Techniques**

Distressing	Heirloom

**Species Availability (Wood)**

Alder	Rustic Alder	Cherry	Hickory	Maple	Oak
		•		•	

**Species Availability (All Laminates)**

High Gloss box color	Horiz. Grain on Maple box color	Vert. Grain on Maple box color	Vert. Grain on Cherry box color	Vert. Grain on Hickory box color	Vert. Grain on Oak box color	Thermofoil box color
----------------------	---------------------------------	--------------------------------	---------------------------------	----------------------------------	------------------------------	----------------------

**NEW UNDER PANEL MOULDING, PREMIUM**



**UPM8P**

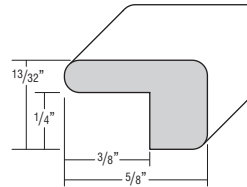

- One 8' section.
- Horizontal grain except on High Gloss.
- Can be used on edges of 1/4" thick panels to conceal end grain.

**Finish Techniques**

Distressing	Heirloom

**Species Availability (Wood)**

Alder	Rustic Alder	Cherry	Hickory	Maple	Oak

**Species Availability (All Laminates)**

High Gloss	Horiz. Grain on Maple	Vert. Grain on Maple	Vert. Grain on Cherry	Vert. Grain on Hickory	Vert. Grain on Oak	Thermofoil
•	•	•	•	•	•	

**TOE MOULDING**

**BASEBOARD**

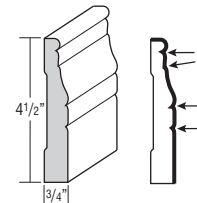

**BBM8**

**BBM10** ♦

- BBM8 is one 8' section.
- BBM10 is one 10' section. 5 day Express Response not available.
- BBM8 can be used in place of standard toekick to provide a surface for glaze hang-up on premium finishes.

**Finish Techniques**

Distressing	Heirloom
•	•

**Species Availability (Wood)**

Alder	Rustic Alder	Cherry	Hickory	Maple	Oak
•	•	•	•	•	•

♦ Only available in Cherry and Maple.

**Species Availability (All Laminates)**

High Gloss box color	Horiz. Grain on Maple box color	Vert. Grain on Maple box color	Vert. Grain on Cherry box color	Vert. Grain on Hickory box color	Vert. Grain on Oak box color	Thermofoil box color
----------------------	---------------------------------	--------------------------------	---------------------------------	----------------------------------	------------------------------	----------------------

♦ Only available in Cherry and Maple box colors.

Finished edges indicated by bold lines on side view drawings.  
Glazed edges indicated by arrows on side view drawings.

**DESCRIPTION**

**MODEL**

**BASEBOARD - SCULPTED**



**BBMSC**

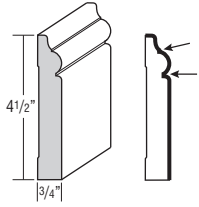

- One 8' section.
- BBMSC can be used in place of standard toekick to provide a surface for glaze hang-up on premium finishes.

**Finish Techniques**

Distressing	Heirlooming
	•

**Species Availability (Wood)**

Alder	Rustic Alder	Cherry	Hickory	Maple	Oak
•	•	•	•	•	•

**Species Availability (All Laminates)**

High Gloss box color	Horiz. Grain on Maple box color	Vert. Grain on Maple box color	Vert. Grain on Cherry box color	Vert. Grain on Hickory box color	Vert. Grain on Oak box color	Thermofoil box color

**BASEBOARD - SHAKER**



**BBMSH8**

**BBMSH10 ♦**

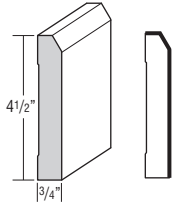

- BBMSH8 is one 8' section.
- BBMSH10 is one 10' section. 5 day Express Response not available.

**Finish Techniques**

Distressing	Heirlooming
•	•

**Species Availability (Wood)**

Alder	Rustic Alder	Cherry	Hickory	Maple	Oak
•	•	•	•	•	•

♦ Only available in Cherry and Maple.

**Species Availability (All Laminates)**

High Gloss box color	Horiz. Grain on Maple box color	Vert. Grain on Maple box color	Vert. Grain on Cherry box color	Vert. Grain on Hickory box color	Vert. Grain on Oak box color	Thermofoil box color

♦ Only available in Cherry and Maple box colors.

**BASEBOARD - SWOOPED**



**BBMSW**

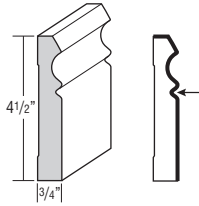

- One 8' section.
- BBMSW can be used in place of standard toekick to provide a surface for glaze hang-up on premium finishes.

**Finish Techniques**

Distressing	Heirlooming
	•

**Species Availability (Wood)**

Alder	Rustic Alder	Cherry	Hickory	Maple	Oak
•	•	•	•	•	•

**Species Availability (All Laminates)**

High Gloss box color	Horiz. Grain on Maple box color	Vert. Grain on Maple box color	Vert. Grain on Cherry box color	Vert. Grain on Hickory box color	Vert. Grain on Oak box color	Thermofoil box color

**DESCRIPTION**

**MODEL**

**TOEBOARDS**



**TB8LAM18 ♦**

**TB8WD14**

**TB8LAM12 ♦**

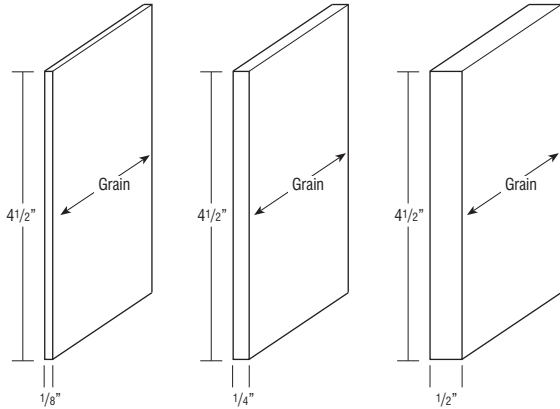

- TB8LAM18 is 1/8" laminated furniture board (White only).
- TB8WD14 in Stains: 1/4" thick veneered furniture board.
- TB8WD14 in Paints: 1/4" thick veneered or solid furniture board.
- TB8LAM12 is 1/2" laminated furniture board (White only).
- One 8' section.

**Finish Techniques**

Distressing	Heirlooming

**Species Availability (Wood)**

Alder	Rustic Alder	Cherry	Hickory	Maple	Oak
•	•	•	•	•	•

♦ Only available in White Laminates.

**Species Availability (All Laminates)**

High Gloss box color	Horiz. Grain on Maple box color	Vert. Grain on Maple box color	Vert. Grain on Cherry box color	Vert. Grain on Hickory box color	Vert. Grain on Oak box color	Thermofoil box color

♦ Only available in White laminate.

**TOEBOARDS, PREMIUM**



**TB8P14**

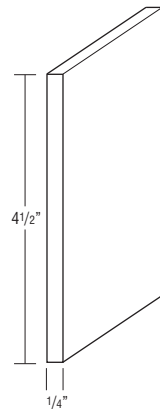

- 1/4" thick laminated MDF.
- One 8' section.
- Horizontal grain except on High Gloss.

**Finish Techniques**

Distressing	Heirlooming

**Species Availability (Wood)**

Alder	Rustic Alder	Cherry	Hickory	Maple	Oak

**Species Availability (All Laminates)**

High Gloss	Horiz. Grain on Maple	Vert. Grain on Maple	Vert. Grain on Cherry	Vert. Grain on Hickory	Vert. Grain on Oak	Thermofoil
•	•	•	•	•	•	

Finished edges indicated by bold lines on side view drawings.  
Glazed edges indicated by arrows on side view drawings.

**DESCRIPTION**

**MODEL**

**TOEKICK CAP**



**TKC**

- Sold in pairs.

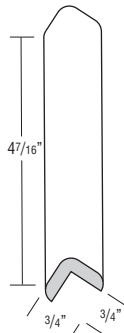

**Finish Techniques**

Distressing	Heirlooming
-------------	-------------

**Species Availability (Wood)**

Alder	Rustic Alder	Cherry	Hickory	Maple	Oak
Maple	Maple	Maple	Oak	•	•

**Species Availability (All Laminates)**

High Gloss	Horiz. Grain on Maple	Vert. Grain on Maple	Vert. Grain on Cherry	Vert. Grain on Hickory	Vert. Grain on Oak	Thermofoil
box color	box color	box color	box color	box color	box color	box color

**WINDOW CASING**

**WINDOW CASING - TRADITIONAL**



**WCT8**

- One 8' section.

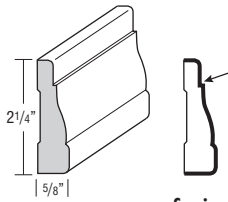

**Finish Techniques**

Distressing	Heirlooming
-------------	-------------

**Species Availability (Wood)**

Alder	Rustic Alder	Cherry	Hickory	Maple	Oak
•	Alder	•	•	•	•

**Species Availability (All Laminates)**

High Gloss	Horiz. Grain on Maple	Vert. Grain on Maple	Vert. Grain on Cherry	Vert. Grain on Hickory	Vert. Grain on Oak	Thermofoil
box color	box color	box color	box color	box color	box color	box color

**LIGHT RAILS**

**CAP MOULDING**



**CAPM**

- One 8' section.

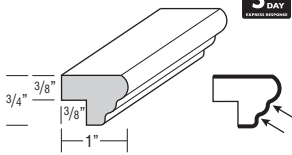

**Finish Techniques**

Distressing	Heirlooming
-------------	-------------

**Species Availability (Wood)**

Alder	Rustic Alder	Cherry	Hickory	Maple	Oak
•	Alder	•	•	•	•

**Species Availability (All Laminates)**

High Gloss	Horiz. Grain on Maple	Vert. Grain on Maple	Vert. Grain on Cherry	Vert. Grain on Hickory	Vert. Grain on Oak	Thermofoil
box color	box color	box color	box color	box color	box color	box color

**LIGHT BAFFLE**



**LB2**

- One 8' section.

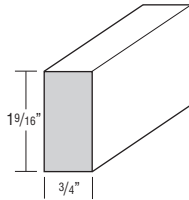

**Finish Techniques**

Distressing	Heirlooming
-------------	-------------

**Species Availability (Wood)**

Alder	Rustic Alder	Cherry	Hickory	Maple	Oak
•	Alder	•	•	•	•

**Species Availability (All Laminates)**

High Gloss	Horiz. Grain on Maple	Vert. Grain on Maple	Vert. Grain on Cherry	Vert. Grain on Hickory	Vert. Grain on Oak	Thermofoil
box color	box color	box color	box color	box color	box color	box color

**DESCRIPTION**

**MODEL**

**NEW LIGHT BAFFLE, PREMIUM**



**LB2P**

- One 8' section.
- Horizontal grain except on High Gloss.

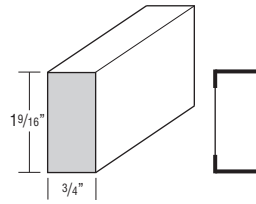

**Finish Techniques**

Distressing	Heirlooming
-------------	-------------

**Species Availability (Wood)**

Alder	Rustic Alder	Cherry	Hickory	Maple	Oak
•	•	•	•	•	•

**Species Availability (All Laminates)**

High Gloss	Horiz. Grain on Maple	Vert. Grain on Maple	Vert. Grain on Cherry	Vert. Grain on Hickory	Vert. Grain on Oak	Thermofoil
•	•	•	•	•	•	

**SMALL LIGHT RAIL MOULDING**



**SMLR**

- One 8' section.

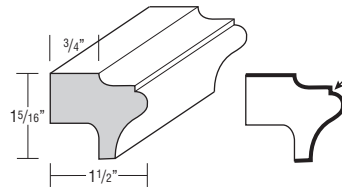

**Finish Techniques**

Distressing	Heirlooming
-------------	-------------

**Species Availability (Wood)**

Alder	Rustic Alder	Cherry	Hickory	Maple	Oak
•	•	•	•	•	•

**Species Availability (All Laminates)**

High Gloss	Horiz. Grain on Maple	Vert. Grain on Maple	Vert. Grain on Cherry	Vert. Grain on Hickory	Vert. Grain on Oak	Thermofoil
box color	box color	box color	box color	box color	box color	box color

**LIGHT RAIL MOULDING**



**LRM**

- One 8' section.

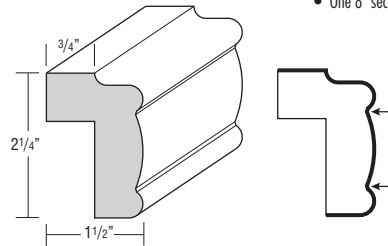

**Finish Techniques**

Distressing	Heirlooming
-------------	-------------

**Species Availability (Wood)**

Alder	Rustic Alder	Cherry	Hickory	Maple	Oak
•	•	•	•	•	•

**Species Availability (All Laminates)**

High Gloss	Horiz. Grain on Maple	Vert. Grain on Maple	Vert. Grain on Cherry	Vert. Grain on Hickory	Vert. Grain on Oak	Thermofoil
box color	box color	box color	box color	box color	box color	box color

**VALLEY FORGE**



**VFR8**

- Must be shimmed at shaded area if used with full overlay styles.
- One 8' section.

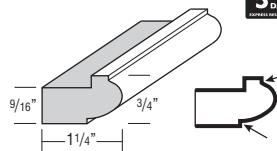

**Finish Techniques**

Distressing	Heirlooming
-------------	-------------

**Species Availability (Wood)**

Alder	Rustic Alder	Cherry	Hickory	Maple	Oak
•	Alder	•	•	•	•

**Species Availability (All Laminates)**

High Gloss	Horiz. Grain on Maple	Vert. Grain on Maple	Vert. Grain on Cherry	Vert. Grain on Hickory	Vert. Grain on Oak	Thermofoil
box color	box color	box color	box color	box color	box color	box color

Finished edges indicated by bold lines on side view drawings.  
Glazed edges indicated by arrows on side view drawings.

DESCRIPTION

MODEL

TRADITIONAL LIGHT RAIL



JINSERTLRT

- One 8' section.
- Designed for use with all 3/4" insert mouldings.

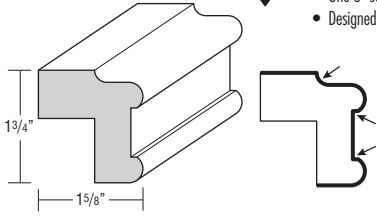

Finish Techniques

Distressing	Heirlooming
	•

Species Availability (Wood)

Alder	Rustic Alder	Cherry	Hickory	Maple	Oak
•	Alder	•		•	•

Species Availability (All Laminates)

High Gloss box color	Horiz. Grain on Maple box color	Vert. Grain on Maple box color	Vert. Grain on Cherry box color	Vert. Grain on Hickory	Vert. Grain on Oak box color	Thermofoil box color
----------------------	---------------------------------	--------------------------------	---------------------------------	------------------------	------------------------------	----------------------

CONTEMPORARY LIGHT RAIL



JINSERTLRC

- One 8' section.
- Designed for use with all 3/4" insert mouldings.

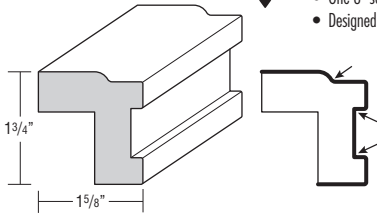

Finish Techniques

Distressing	Heirlooming
	•

Species Availability (Wood)

Alder	Rustic Alder	Cherry	Hickory	Maple	Oak
•	Alder	•		•	•

Species Availability (All Laminates)

High Gloss box color	Horiz. Grain on Maple box color	Vert. Grain on Maple box color	Vert. Grain on Cherry box color	Vert. Grain on Hickory	Vert. Grain on Oak box color	Thermofoil box color
----------------------	---------------------------------	--------------------------------	---------------------------------	------------------------	------------------------------	----------------------

LIGHT RAIL INSERTS

ACANTHUS LIGHT RAIL INSERT



JLRINSACAN

- One 8' section.
- Pattern is 6" repeat.

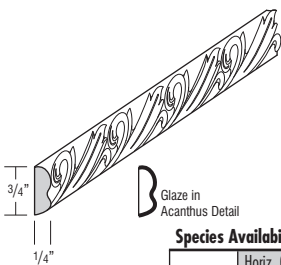

Finish Techniques

Distressing	Heirlooming
	•

Species Availability (Wood)

Alder	Rustic Alder	Cherry	Hickory	Maple	Oak
•	Alder	•		•	

Species Availability (All Laminates)

High Gloss box color	Horiz. Grain on Maple box color	Vert. Grain on Maple box color	Vert. Grain on Cherry box color	Vert. Grain on Hickory	Vert. Grain on Oak box color	Thermofoil box color
----------------------	---------------------------------	--------------------------------	---------------------------------	------------------------	------------------------------	----------------------

CELTIC LIGHT RAIL INSERT



JLRINSCELT

- One 8' section.
- Pattern is 6" repeat.

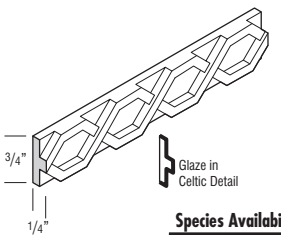

Finish Techniques

Distressing	Heirlooming
	•

Species Availability (Wood)

Alder	Rustic Alder	Cherry	Hickory	Maple	Oak
•	Alder	•		•	

Species Availability (All Laminates)

High Gloss box color	Horiz. Grain on Maple box color	Vert. Grain on Maple box color	Vert. Grain on Cherry box color	Vert. Grain on Hickory	Vert. Grain on Oak box color	Thermofoil box color
----------------------	---------------------------------	--------------------------------	---------------------------------	------------------------	------------------------------	----------------------

DESCRIPTION

MODEL

MISSION LIGHT RAIL INSERT



JLRINSMIS

- One 8' section.
- Pattern is 6" repeat.

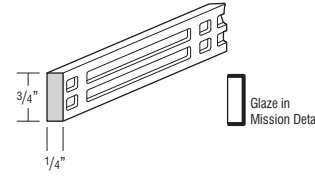

Finish Techniques

Distressing	Heirlooming
	•

Species Availability (Wood)

Alder	Rustic Alder	Cherry	Hickory	Maple	Oak
•	Alder	•		•	

Species Availability (All Laminates)

High Gloss box color	Horiz. Grain on Maple box color	Vert. Grain on Maple box color	Vert. Grain on Cherry box color	Vert. Grain on Hickory	Vert. Grain on Oak	Thermofoil box color
----------------------	---------------------------------	--------------------------------	---------------------------------	------------------------	--------------------	----------------------

WEAVE LIGHT RAIL INSERT



JLRINSWEAVE

- One 8' section.
- Pattern is 6" repeat.

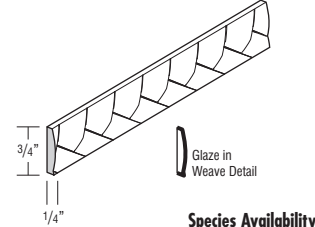

Finish Techniques

Distressing	Heirlooming
	•

Species Availability (Wood)

Alder	Rustic Alder	Cherry	Hickory	Maple	Oak
•	Alder	•		•	

Species Availability (All Laminates)

High Gloss box color	Horiz. Grain on Maple box color	Vert. Grain on Maple box color	Vert. Grain on Cherry box color	Vert. Grain on Hickory	Vert. Grain on Oak	Thermofoil box color
----------------------	---------------------------------	--------------------------------	---------------------------------	------------------------	--------------------	----------------------

CORNER MOULDINGS

DIAGONAL CORNER



DCM8

- Designed to set cabinets at a 45° corner application using 3/4" end panels.
- One 8' section.
- Not compatible on cabinets with Furniture Ends (FPEB) or Authentic Ends (AUTHL/AUTHR).

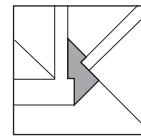
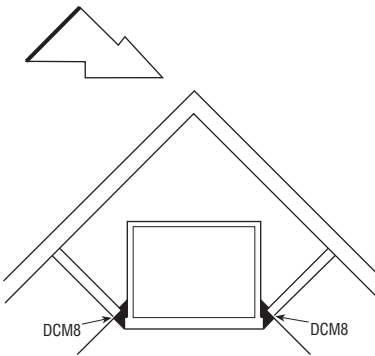
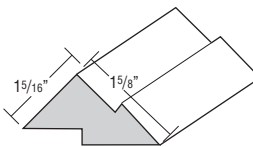

Finish Techniques

Distressing	Heirlooming
	•

Species Availability (Wood)

Alder	Rustic Alder	Cherry	Hickory	Maple	Oak
•	Alder	•	•	•	•

Species Availability (All Laminates)

High Gloss box color	Horiz. Grain on Maple box color	Vert. Grain on Maple box color	Vert. Grain on Cherry box color	Vert. Grain on Hickory box color	Vert. Grain on Oak box color	Thermofoil box color
----------------------	---------------------------------	--------------------------------	---------------------------------	----------------------------------	------------------------------	----------------------

Finished edges indicated by bold lines on side view drawings.  
Glazed edges indicated by arrows on side view drawings.

**DESCRIPTION**

**MODEL**

**INSIDE CORNER**



**ICM8**

- One 8' section.

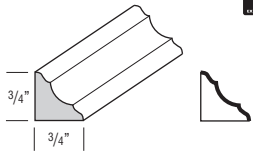

**Finish Techniques**

Distressing	Heirlooming

**Species Availability (Wood)**

Alder	Rustic Alder	Cherry	Hickory	Maple	Oak
•	Alder	•	•	•	•

**Species Availability (All Laminates)**

High Gloss	Horiz. Grain on Maple	Vert. Grain on Maple	Vert. Grain on Cherry	Vert. Grain on Hickory	Vert. Grain on Oak	Thermofoil
box color	box color	box color	box color	box color	box color	box color

**INSIDE CORNER, PREMIUM**



**ICM8P**

- One 8' section.
- Horizontal grain except on High Gloss.

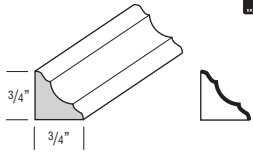

**Finish Techniques**

Distressing	Heirlooming

**Species Availability (Wood)**

Alder	Rustic Alder	Cherry	Hickory	Maple	Oak
•	Alder	•	•	•	•

**Species Availability (All Laminates)**

High Gloss	Horiz. Grain on Maple	Vert. Grain on Maple	Vert. Grain on Cherry	Vert. Grain on Hickory	Vert. Grain on Oak	Thermofoil
•	•	•	•	•	•	

**LARGE OUTSIDE CORNER**



**LOSC8**

- One 8' section.

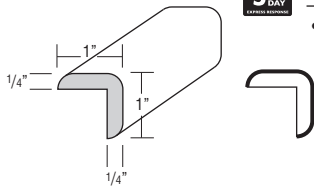

**Finish Techniques**

Distressing	Heirlooming

**Species Availability (Wood)**

Alder	Rustic Alder	Cherry	Hickory	Maple	Oak
•	Alder	•	•	•	•

**Species Availability (All Laminates)**

High Gloss	Horiz. Grain on Maple	Vert. Grain on Maple	Vert. Grain on Cherry	Vert. Grain on Hickory	Vert. Grain on Oak	Thermofoil
box color	box color	box color	box color	box color	box color	box color

**OUTSIDE CORNER**



**OCM8**

- One 8' section.

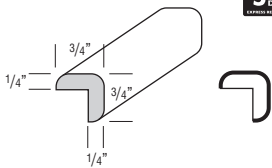

**Finish Techniques**

Distressing	Heirlooming

**Species Availability (Wood)**

Alder	Rustic Alder	Cherry	Hickory	Maple	Oak
•	Alder	•	•	•	•

**Species Availability (All Laminates)**

High Gloss	Horiz. Grain on Maple	Vert. Grain on Maple	Vert. Grain on Cherry	Vert. Grain on Hickory	Vert. Grain on Oak	Thermofoil
box color	box color	box color	box color	box color	box color	box color

**DESCRIPTION**

**MODEL**

**OUTSIDE CORNER, PREMIUM**



**OCM8P**

- One 8' section.
- Horizontal grain except on High Gloss.

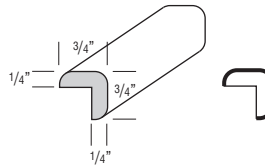

**Finish Techniques**

Distressing	Heirlooming

**Species Availability (Wood)**

Alder	Rustic Alder	Cherry	Hickory	Maple	Oak
•	Alder	•	•	•	•

**Species Availability (All Laminates)**

High Gloss	Horiz. Grain on Maple	Vert. Grain on Maple	Vert. Grain on Cherry	Vert. Grain on Hickory	Vert. Grain on Oak	Thermofoil
•	•	•	•	•	•	

**OUTSIDE CORNER 135°**



**OC135**

- One 8' section.

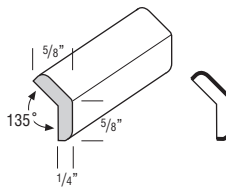

**Finish Techniques**

Distressing	Heirlooming

**Species Availability (Wood)**

Alder	Rustic Alder	Cherry	Hickory	Maple	Oak
•	Alder	•	•	•	•

**Species Availability (All Laminates)**

High Gloss	Horiz. Grain on Maple	Vert. Grain on Maple	Vert. Grain on Cherry	Vert. Grain on Hickory	Vert. Grain on Oak	Thermofoil
box color	box color	box color	box color	box color	box color	box color

**QUARTER ROUND MOULDING**



**QRM**

- One 8' section.

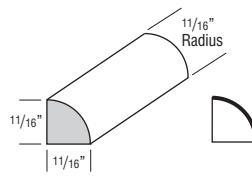

**Finish Techniques**

Distressing	Heirlooming

**Species Availability (Wood)**

Alder	Rustic Alder	Cherry	Hickory	Maple	Oak
•	Alder	•	•	•	•

**Species Availability (All Laminates)**

High Gloss	Horiz. Grain on Maple	Vert. Grain on Maple	Vert. Grain on Cherry	Vert. Grain on Hickory	Vert. Grain on Oak	Thermofoil
box color	box color	box color	box color	box color	box color	box color

**SHOE - CONVEX INSIDE CORNER**



**SHM8**

- One 8' section.

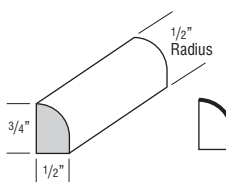

**Finish Techniques**

Distressing	Heirlooming

**Species Availability (Wood)**

Alder	Rustic Alder	Cherry	Hickory	Maple	Oak
•	Alder	•	•	•	•

**Species Availability (All Laminates)**

High Gloss	Horiz. Grain on Maple	Vert. Grain on Maple	Vert. Grain on Cherry	Vert. Grain on Hickory	Vert. Grain on Oak	Thermofoil
box color	box color	box color	box color	box color	box color	box color

Finished edges indicated by bold lines on side view drawings.  
Glazed edges indicated by arrows on side view drawings.

DESCRIPTION

MODEL

VALANCES

ARCHED VALANCE



AV36

AV48

AV60

AV72

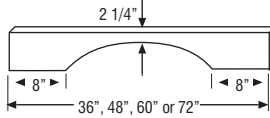

- Side shoulders are 8" wide (6" trimmable each end).
- Bottom edge has 3/16" radius.
- 3/4" thick.

Finish Techniques

Distressing	Heirloom
•	•

Species Availability (Wood)

Alder	Rustic Alder	Cherry	Hickory	Maple	Oak
•	•	•	•	•	•

Species Availability (All Laminates)

High Gloss box color	Horiz. Grain on Maple box color	Vert. Grain on Maple box color	Vert. Grain on Cherry box color	Vert. Grain on Hickory box color	Vert. Grain on Oak box color	Thermofoil box color
----------------------	---------------------------------	--------------------------------	---------------------------------	----------------------------------	------------------------------	----------------------

FURNITURE VALANCE



FV36

FV48

FV60

FV72

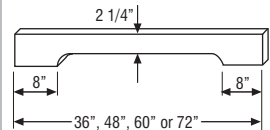

- Side shoulders are 8" wide (6" trimmable each end).
- Bottom edge has 3/16" radius profile on face.
- 3/4" thick.

Finish Techniques

Distressing	Heirloom
•	•

Species Availability (Wood)

Alder	Rustic Alder	Cherry	Hickory	Maple	Oak
•	•	•	•	•	•

Species Availability (All Laminates)

High Gloss box color	Horiz. Grain on Maple box color	Vert. Grain on Maple box color	Vert. Grain on Cherry box color	Vert. Grain on Hickory box color	Vert. Grain on Oak box color	Thermofoil box color
----------------------	---------------------------------	--------------------------------	---------------------------------	----------------------------------	------------------------------	----------------------

RAISED PANEL ARCH VALANCE



JRPV30

JRPV36

JRPV42

JRPV48

JRPV54

JRPV60

JRPV72

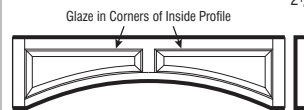
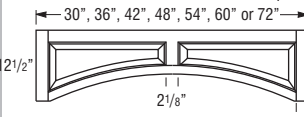

- Trimmable up to 1 3/4" per side.
- Recommended for use with hearths, see page 166.
- Center height 8".
- Raised panel profile is unique to this item and does not match any door style.
- Ends are pocket drilled for installation to adjacent cabinet frames.

Finish Techniques

Distressing	Heirloom
•	•

Species Availability (Wood)

Alder	Rustic Alder	Cherry	Hickory	Maple	Oak
•	•	•	•	•	•

Species Availability (All Laminates)

High Gloss box color	Horiz. Grain on Maple box color	Vert. Grain on Maple box color	Vert. Grain on Cherry box color	Vert. Grain on Hickory box color	Vert. Grain on Oak box color	Thermofoil box color
----------------------	---------------------------------	--------------------------------	---------------------------------	----------------------------------	------------------------------	----------------------

DESCRIPTION

MODEL

RECESSED PANEL ARCH VALANCE



JRCPV30

JRCPV36

JRCPV42

JRCPV48

JRCPV54

JRCPV60

JRCPV72

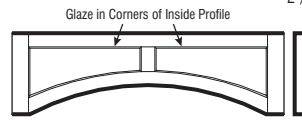
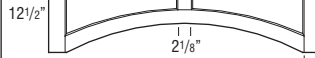

- Trimmable up to 1 3/4" per side.
- Recommended for use with hearths, see page 166.
- Center height 8".
- Ends are pocket drilled for installation to adjacent cabinet frames.

Finish Techniques

Distressing	Heirloom
•	•

Species Availability (Wood)

Alder	Rustic Alder	Cherry	Hickory	Maple	Oak
•	•	•	•	•	•

Species Availability (All Laminates)

High Gloss box color	Horiz. Grain on Maple box color	Vert. Grain on Maple box color	Vert. Grain on Cherry box color	Vert. Grain on Hickory box color	Vert. Grain on Oak box color	Thermofoil box color
----------------------	---------------------------------	--------------------------------	---------------------------------	----------------------------------	------------------------------	----------------------

SCALLOPED VALANCE



SV48

- Trimmable.
- 3/4" thick.

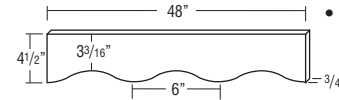

Finish Techniques

Distressing	Heirloom
•	•

Species Availability (Wood)

Alder	Rustic Alder	Cherry	Hickory	Maple	Oak
•	•	•	•	•	•

Species Availability (All Laminates)

High Gloss box color	Horiz. Grain on Maple box color	Vert. Grain on Maple box color	Vert. Grain on Cherry box color	Vert. Grain on Hickory box color	Vert. Grain on Oak box color	Thermofoil box color
----------------------	---------------------------------	--------------------------------	---------------------------------	----------------------------------	------------------------------	----------------------

STRAIGHT VALANCE



VV48

VV72

VV96

VV120 ♦

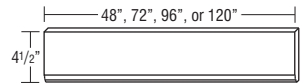

- Trimmable.
- 3/4" thick.

Finish Techniques

Distressing	Heirloom
•	•

Species Availability (Wood)

Alder	Rustic Alder	Cherry	Hickory	Maple	Oak
•	•	•	•	•	•

♦ Only available in Cherry and Maple.

Species Availability (All Laminates)

High Gloss box color	Horiz. Grain on Maple box color	Vert. Grain on Maple box color	Vert. Grain on Cherry box color	Vert. Grain on Hickory box color	Vert. Grain on Oak box color	Thermofoil box color
----------------------	---------------------------------	--------------------------------	---------------------------------	----------------------------------	------------------------------	----------------------

♦ Only available in Cherry and Maple box colors.

Finished edges indicated by bold lines on side view drawings.  
Glazed edges indicated by arrows on side view drawings.

**DESCRIPTION MODEL**  
**DECORATIVE OVERLAYS**

**ACANTHUS OVERLAY**



**ACOVLV**

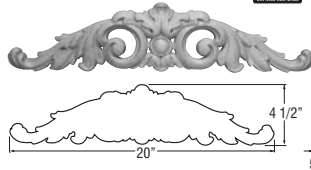

- Apply with small brad.
- Cannot be installed on valances.



**Finish Techniques**

Distressing	Heirloom
	•

**Species Availability (Wood)**

Alder	Rustic Alder	Cherry	Hickory	Maple	Oak
•	Alder	•		•	

**Species Availability (All Laminates)**

High Gloss box color	Horiz. Grain on Maple box color	Vert. Grain on Maple box color	Vert. Grain on Cherry box color	Vert. Grain on Hickory	Vert. Grain on Oak	Thermofoil box color
-------------------------	---------------------------------------	--------------------------------------	---------------------------------------	---------------------------	-----------------------	-------------------------

**CELTIC OVERLAY**



**JCELOVLY**

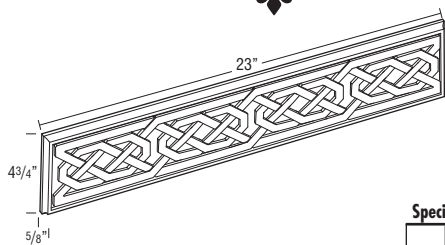

**Finish Techniques**

Distressing	Heirloom
	•

**Species Availability (Wood)**

Alder	Rustic Alder	Cherry	Hickory	Maple	Oak
		•		•	•

**Species Availability (All Laminates)**

High Gloss box color	Horiz. Grain on Maple box color	Vert. Grain on Maple box color	Vert. Grain on Cherry box color	Vert. Grain on Hickory	Vert. Grain on Oak box color	Thermofoil box color
-------------------------	---------------------------------------	--------------------------------------	---------------------------------------	---------------------------	------------------------------------	-------------------------

**DECORATIVE ORNAMENTS**

**ACANTHUS ORNAMENT**



**ACO**

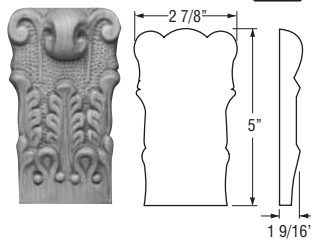

- Apply with small brad.

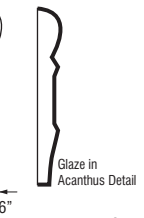

**Finish Techniques**

Distressing	Heirloom
	•

**Species Availability (Wood)**

Alder	Rustic Alder	Cherry	Hickory	Maple	Oak
		•		•	

**Species Availability (All Laminates)**

High Gloss box color	Horiz. Grain on Maple box color	Vert. Grain on Maple box color	Vert. Grain on Cherry box color	Vert. Grain on Hickory	Vert. Grain on Oak	Thermofoil box color
-------------------------	---------------------------------------	--------------------------------------	---------------------------------------	---------------------------	-----------------------	-------------------------

**DESCRIPTION MODEL**

**MISSION ROSETTE**



**ROSETTEMIS**

- Apply with small brad.

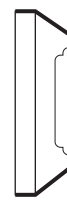
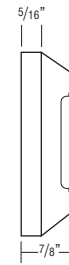
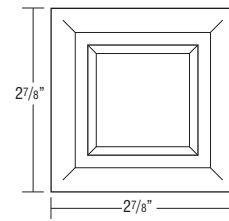

Glaze in Mission Detail

**Finish Techniques**

Distressing	Heirloom
	•

**Species Availability (Wood)**

Alder	Rustic Alder	Cherry	Hickory	Maple	Oak
•	Alder	•		•	•

**Species Availability (All Laminates)**

High Gloss box color	Horiz. Grain on Maple box color	Vert. Grain on Maple box color	Vert. Grain on Cherry box color	Vert. Grain on Hickory	Vert. Grain on Oak box color	Thermofoil box color
-------------------------	---------------------------------------	--------------------------------------	---------------------------------------	---------------------------	------------------------------------	-------------------------

**SCROLL ROSETTE**



**ROSETTESCR**

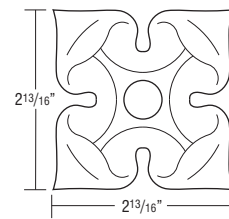

Glaze in Rosette Detail

**Finish Techniques**

Distressing	Heirloom
	•

**Species Availability (Wood)**

Alder	Rustic Alder	Cherry	Hickory	Maple	Oak
•	Alder	•		•	•

**Species Availability (All Laminates)**

High Gloss box color	Horiz. Grain on Maple box color	Vert. Grain on Maple box color	Vert. Grain on Cherry box color	Vert. Grain on Hickory	Vert. Grain on Oak box color	Thermofoil box color
-------------------------	---------------------------------------	--------------------------------------	---------------------------------------	---------------------------	------------------------------------	-------------------------

**TRADITIONAL ROSETTE**



**TROSETTE**

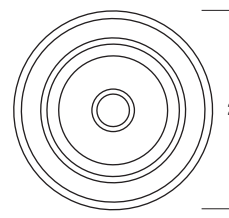

Glaze in Rosette Detail

**Finish Techniques**

Distressing	Heirloom
	•

**Species Availability (Wood)**

Alder	Rustic Alder	Cherry	Hickory	Maple	Oak
Cherry	Cherry	•	Beech	•	Beech

**Species Availability (All Laminates)**

High Gloss box color	Horiz. Grain on Maple box color	Vert. Grain on Maple box color	Vert. Grain on Cherry box color	Vert. Grain on Hickory	Vert. Grain on Oak box color	Thermofoil box color
-------------------------	---------------------------------------	--------------------------------------	---------------------------------------	---------------------------	------------------------------------	-------------------------

Finished edges indicated by bold lines on side view drawings.  
Glazed edges indicated by arrows on side view drawings.



**DESCRIPTION**

**MODEL**

**CORNER ROSETTE, 3"**



**FFRC3X3** (Fluted)  
**BFRC3X3** (Beaded)

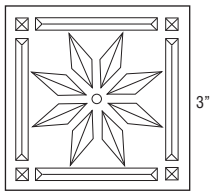

**Back Views of Rosette**

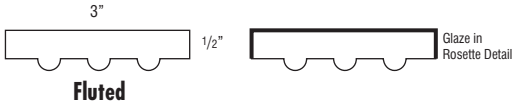

**Fluted**

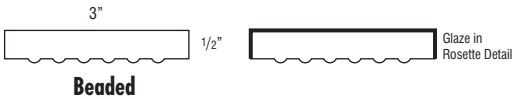

**Beaded**

**Finish Techniques**

Distressing	Heirlooming
	•

**Species Availability (Wood)**

Alder	Rustic Alder	Cherry	Hickory	Maple	Oak
•	Alder	•	•	•	•

**Species Availability (All Laminates)**

High Gloss box color	Horiz. Grain on Maple box color	Vert. Grain on Maple box color	Vert. Grain on Cherry box color	Vert. Grain on Hickory box color	Vert. Grain on Oak box color	Thermofoil box color
----------------------	---------------------------------	--------------------------------	---------------------------------	----------------------------------	------------------------------	----------------------

**CELTIC ROSETTE**



**ROSETTCEL**

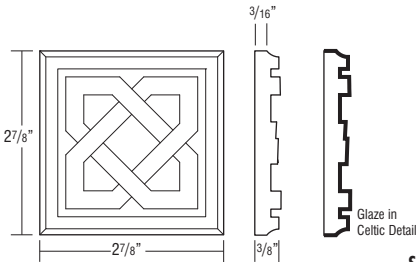

**Finish Techniques**

Distressing	Heirlooming
	•

**Species Availability (Wood)**

Alder	Rustic Alder	Cherry	Hickory	Maple	Oak
		•			•

**Species Availability (All Laminates)**

High Gloss box color	Horiz. Grain on Maple box color	Vert. Grain on Maple box color	Vert. Grain on Cherry box color	Vert. Grain on Hickory box color	Vert. Grain on Oak box color	Thermofoil box color
----------------------	---------------------------------	--------------------------------	---------------------------------	----------------------------------	------------------------------	----------------------

**DESCRIPTION**

**MODEL**

**PLINTH BLOCK FILLER, 3"**



**FFP3X8** (Fluted)  
**BFPC3X8** (Beaded)

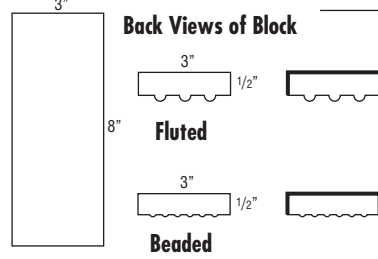

**Back Views of Block**



**Fluted**

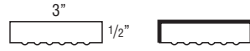

**Beaded**

**Finish Techniques**

Distressing	Heirlooming
	•

**Species Availability (Wood)**

Alder	Rustic Alder	Cherry	Hickory	Maple	Oak
•	Alder	•		•	•

**Species Availability (All Laminates)**

High Gloss box color	Horiz. Grain on Maple box color	Vert. Grain on Maple box color	Vert. Grain on Cherry box color	Vert. Grain on Hickory box color	Vert. Grain on Oak box color	Thermofoil box color
----------------------	---------------------------------	--------------------------------	---------------------------------	----------------------------------	------------------------------	----------------------

**CORNER ROSETTE, 6"**



**FFRC6X6** (Fluted)

- Available only as fluted.

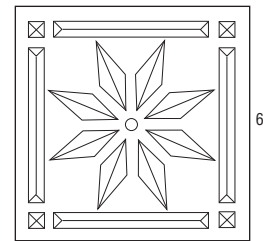

**Back View of Rosette**



**Finish Techniques**

Distressing	Heirlooming

**Species Availability (Wood)**

Alder	Rustic Alder	Cherry	Hickory	Maple	Oak
•	Alder	•	•	•	•

**Species Availability (All Laminates)**

High Gloss box color	Horiz. Grain on Maple box color	Vert. Grain on Maple box color	Vert. Grain on Cherry box color	Vert. Grain on Hickory box color	Vert. Grain on Oak box color	Thermofoil box color
----------------------	---------------------------------	--------------------------------	---------------------------------	----------------------------------	------------------------------	----------------------

Finished edges indicated by bold lines on side view drawings.  
Glazed edges indicated by arrows on side view drawings.



**DESCRIPTION**

**MODEL**

**ACANTHUS TILE**

**JTILEACAN**

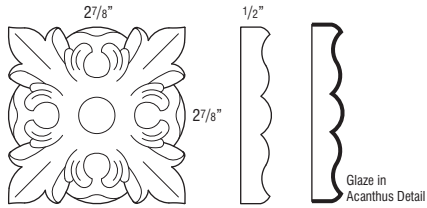

**Finish Techniques**

Distressing	Heirlooming
	•

**Species Availability (Wood)**

Alder	Rustic Alder	Cherry	Hickory	Maple	Oak
•	Alder	•		•	•

**Species Availability (All Laminates)**

High Gloss box color	Horiz. Grain on Maple box color	Vert. Grain on Maple box color	Vert. Grain on Cherry box color	Vert. Grain on Hickory	Vert. Grain on Oak box color	Thermofoil box color
-------------------------	---------------------------------------	--------------------------------------	---------------------------------------	---------------------------	------------------------------------	-------------------------

**MISSION TILE**

**JTILEMISSION**

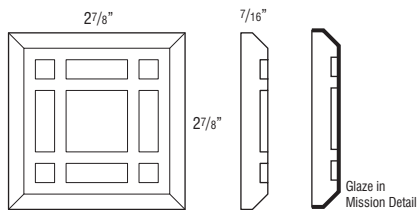

**Finish Techniques**

Distressing	Heirlooming
	•

**Species Availability (Wood)**

Alder	Rustic Alder	Cherry	Hickory	Maple	Oak
•	Alder	•		•	•

**Species Availability (All Laminates)**

High Gloss box color	Horiz. Grain on Maple box color	Vert. Grain on Maple box color	Vert. Grain on Cherry box color	Vert. Grain on Hickory	Vert. Grain on Oak box color	Thermofoil box color
-------------------------	---------------------------------------	--------------------------------------	---------------------------------------	---------------------------	------------------------------------	-------------------------

**PLINTH BLOCK FILLER, 6"**



**FFP6X8 (Fluted)**

- Available only as fluted.

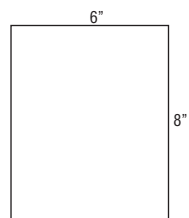

**Back View of Block**

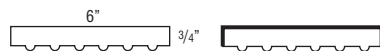

**Finish Techniques**

Distressing	Heirlooming
	•

**Species Availability (Wood)**

Alder	Rustic Alder	Cherry	Hickory	Maple	Oak
•	Alder	•	•	•	•

**Species Availability (All Laminates)**

High Gloss box color	Horiz. Grain on Maple box color	Vert. Grain on Maple box color	Vert. Grain on Cherry box color	Vert. Grain on Hickory box color	Vert. Grain on Oak box color	Thermofoil box color
-------------------------	---------------------------------------	--------------------------------------	---------------------------------------	--	------------------------------------	-------------------------

**DESCRIPTION**

**MODEL**

**DECORATIVE SUPPORTS**

**ACANTHUS LEG,  
35 1/4" HIGH**



**JACANTHUSLEG**

- Trimtable.

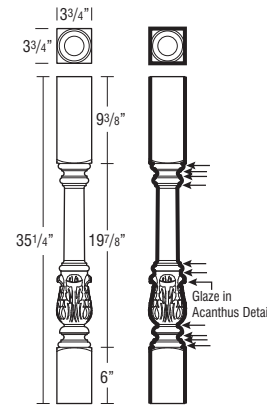

**Finish Techniques**

Distressing	Heirlooming
	•

**Species Availability (Wood)**

Alder	Rustic Alder	Cherry	Hickory	Maple	Oak
•	Alder	•		•	•

**Species Availability (All Laminates)**

High Gloss box color	Horiz. Grain on Maple box color	Vert. Grain on Maple box color	Vert. Grain on Cherry box color	Vert. Grain on Hickory	Vert. Grain on Oak box color	Thermofoil box color
-------------------------	---------------------------------------	--------------------------------------	---------------------------------------	---------------------------	------------------------------------	-------------------------

**BAR LEG, 2-SIDED,  
42 1/4" HIGH**



**2SBARLEG**

- Trimtable.

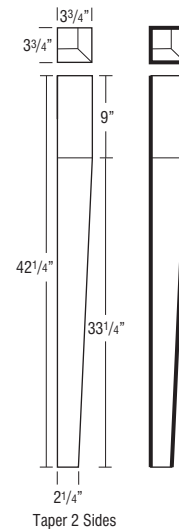

**Finish Techniques**

Distressing	Heirlooming
	•

**Species Availability (Wood)**

Alder	Rustic Alder	Cherry	Hickory	Maple	Oak
•	Alder	•		•	•

**Species Availability (All Laminates)**

High Gloss box color	Horiz. Grain on Maple box color	Vert. Grain on Maple box color	Vert. Grain on Cherry box color	Vert. Grain on Hickory	Vert. Grain on Oak box color	Thermofoil box color
-------------------------	---------------------------------------	--------------------------------------	---------------------------------------	---------------------------	------------------------------------	-------------------------

Finished edges indicated by bold lines on side view drawings.  
Glazed edges indicated by arrows on side view drawings.

DESCRIPTION

MODEL

BAR LEG, 4-SIDED,  
42 1/4" HIGH



4SBARLEG

- Trimmable.

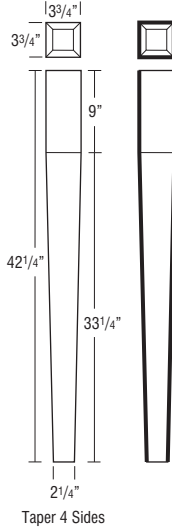

Finish Techniques

Distressing	Heirlooming
	•

Species Availability (Wood)

Alder	Rustic Alder	Cherry	Hickory	Maple	Oak
•	Alder	•		•	•

Species Availability (All Laminates)

High Gloss box color	Horiz. Grain on Maple box color	Vert. Grain on Maple box color	Vert. Grain on Cherry box color	Vert. Grain on Hickory	Vert. Grain on Oak box color	Thermofoil box color
----------------------	---------------------------------	--------------------------------	---------------------------------	------------------------	------------------------------	----------------------

DESCRIPTION

MODEL

COSMO LEG,  
35 1/4" HIGH



JCOSMOLEG

- Trimmable.
- Leg is designed with three pieces joined together.

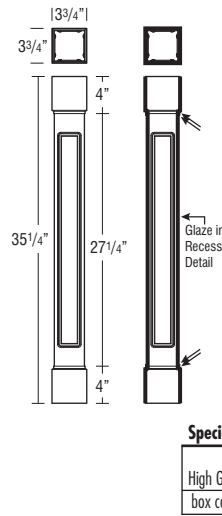

Finish Techniques

Distressing	Heirlooming
	•

Species Availability (Wood)

Alder	Rustic Alder	Cherry	Hickory	Maple	Oak
•	Alder	•		•	•

Species Availability (All Laminates)

High Gloss box color	Horiz. Grain on Maple box color	Vert. Grain on Maple box color	Vert. Grain on Cherry box color	Vert. Grain on Hickory	Vert. Grain on Oak box color	Thermofoil box color
----------------------	---------------------------------	--------------------------------	---------------------------------	------------------------	------------------------------	----------------------

BAROQUE LEG,  
34 1/2" HIGH



JBAROQUELEG

- Trimmable.
- Leg is designed with three pieces. Field assembly required.

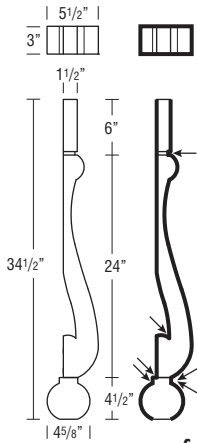

Finish Techniques

Distressing	Heirlooming
	•

Species Availability (Wood)

Alder	Rustic Alder	Cherry	Hickory	Maple	Oak
•	Alder	•		•	•

Species Availability (All Laminates)

High Gloss box color	Horiz. Grain on Maple box color	Vert. Grain on Maple box color	Vert. Grain on Cherry box color	Vert. Grain on Hickory	Vert. Grain on Oak box color	Thermofoil box color
----------------------	---------------------------------	--------------------------------	---------------------------------	------------------------	------------------------------	----------------------

ENGLISH COUNTRY LEG,  
35 1/4" HIGH



JENGCNTYLEG

- Trimmable.

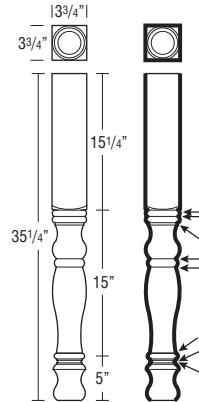

Finish Techniques

Distressing	Heirlooming
	•

Species Availability (Wood)

Alder	Rustic Alder	Cherry	Hickory	Maple	Oak
•	Alder	•		•	•

Species Availability (All Laminates)

High Gloss box color	Horiz. Grain on Maple box color	Vert. Grain on Maple box color	Vert. Grain on Cherry box color	Vert. Grain on Hickory	Vert. Grain on Oak box color	Thermofoil box color
----------------------	---------------------------------	--------------------------------	---------------------------------	------------------------	------------------------------	----------------------

BUFFET LEG,  
34 1/2" HIGH



JBUFFETLEG

- Trimmable.

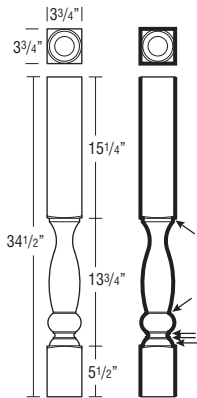

Finish Techniques

Distressing	Heirlooming
	•

Species Availability (Wood)

Alder	Rustic Alder	Cherry	Hickory	Maple	Oak
•	Alder	•		•	•

Species Availability (All Laminates)

High Gloss box color	Horiz. Grain on Maple box color	Vert. Grain on Maple box color	Vert. Grain on Cherry box color	Vert. Grain on Hickory	Vert. Grain on Oak box color	Thermofoil box color
----------------------	---------------------------------	--------------------------------	---------------------------------	------------------------	------------------------------	----------------------

Finished edges indicated by bold lines on side view drawings.  
Glazed edges indicated by arrows on side view drawings.

**DESCRIPTION**

**MODEL**

**ENGLISH BAR COLUMN,  
42 1/4" HIGH**



**ENGBARCOLUMN**

- Trimtable.

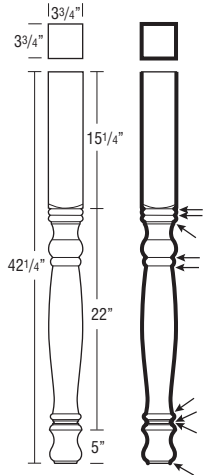

**Finish Techniques**

Distressing	Heirlooming
	•

**Species Availability (Wood)**

Alder	Rustic Alder	Cherry	Hickory	Maple	Oak
•	Alder	•		•	•

**Species Availability (All Laminates)**

High Gloss box color	Horiz. Grain on Maple box color	Vert. Grain on Maple box color	Vert. Grain on Cherry box color	Vert. Grain on Hickory	Vert. Grain on Oak box color	Thermofoil box color
-------------------------	---------------------------------------	--------------------------------------	---------------------------------------	---------------------------	------------------------------------	-------------------------

**DESCRIPTION**

**MODEL**

**SMALL ESTATE LEG,  
2 3/4" WIDE,  
35 1/4" HIGH**



**JESTATELEGS**

- Trimtable.

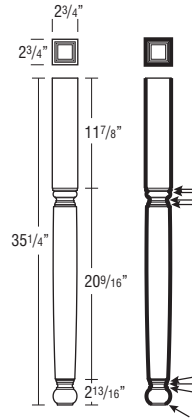

**Finish Techniques**

Distressing	Heirlooming
	•

**Species Availability (Wood)**

Alder	Rustic Alder	Cherry	Hickory	Maple	Oak
•	Alder	•		•	•

**Species Availability (All Laminates)**

High Gloss box color	Horiz. Grain on Maple box color	Vert. Grain on Maple box color	Vert. Grain on Cherry box color	Vert. Grain on Hickory	Vert. Grain on Oak box color	Thermofoil box color
-------------------------	---------------------------------------	--------------------------------------	---------------------------------------	---------------------------	------------------------------------	-------------------------

**ENGLISH ISLAND COLUMN,  
5" WIDE, 35 1/4" HIGH**



**ENGLISCOLUMN**

- Trimtable.

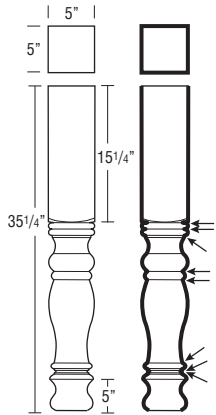

**Finish Techniques**

Distressing	Heirlooming
	•

**Species Availability (Wood)**

Alder	Rustic Alder	Cherry	Hickory	Maple	Oak
•	Alder	•		•	•

**Species Availability (All Laminates)**

High Gloss box color	Horiz. Grain on Maple box color	Vert. Grain on Maple box color	Vert. Grain on Cherry box color	Vert. Grain on Hickory	Vert. Grain on Oak box color	Thermofoil box color
-------------------------	---------------------------------------	--------------------------------------	---------------------------------------	---------------------------	------------------------------------	-------------------------

**SMALL ESTATE LEG  
SPLIT, 2 3/4" WIDE,  
35 1/4" HIGH**



**JESTATELEGSS**

- Trimtable.

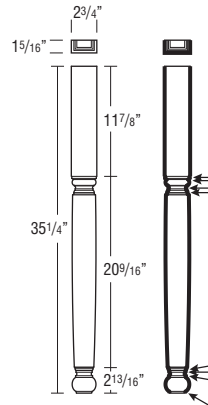

**Finish Techniques**

Distressing	Heirlooming
	•

**Species Availability (Wood)**

Alder	Rustic Alder	Cherry	Hickory	Maple	Oak
•	Alder	•		•	•

**Species Availability (All Laminates)**

High Gloss box color	Horiz. Grain on Maple box color	Vert. Grain on Maple box color	Vert. Grain on Cherry box color	Vert. Grain on Hickory	Vert. Grain on Oak box color	Thermofoil box color
-------------------------	---------------------------------------	--------------------------------------	---------------------------------------	---------------------------	------------------------------------	-------------------------

Finished edges indicated by bold lines on side view drawings.  
Glazed edges indicated by arrows on side view drawings.

**DESCRIPTION**

**ESTATE LEG,  
35 1/4" HIGH**



**MODEL**

**JESTATELEG**

- Trimmable.

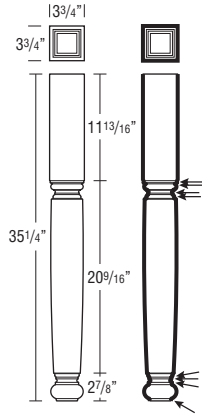

**Finish Techniques**

Distressing	Heirlooming
	•

**Species Availability (Wood)**

Alder	Rustic Alder	Cherry	Hickory	Maple	Oak
•	Alder	•		•	•

**Species Availability (All Laminates)**

High Gloss box color	Horiz. Grain on Maple box color	Vert. Grain on Maple box color	Vert. Grain on Cherry box color	Vert. Grain on Hickory	Vert. Grain on Oak box color	Thermofoil box color
-------------------------	---------------------------------------	--------------------------------------	---------------------------------------	---------------------------	------------------------------------	-------------------------

**SMALL CLASSIC FLUTED  
LEG, 2 3/4" WIDE,  
35 1/4" HIGH**



**JFLUTELEG**

- Trimmable.

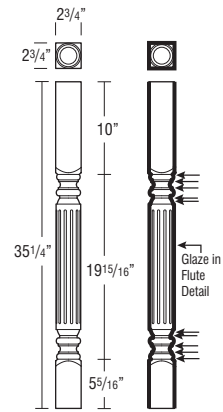

**Finish Techniques**

Distressing	Heirlooming
	•

**Species Availability (Wood)**

Alder	Rustic Alder	Cherry	Hickory	Maple	Oak
•	Alder	•		•	•

**Species Availability (All Laminates)**

High Gloss box color	Horiz. Grain on Maple box color	Vert. Grain on Maple box color	Vert. Grain on Cherry box color	Vert. Grain on Hickory	Vert. Grain on Oak box color	Thermofoil box color
-------------------------	---------------------------------------	--------------------------------------	---------------------------------------	---------------------------	------------------------------------	-------------------------

**DESCRIPTION**

**SMALL CLASSIC FLUTED  
LEG SPLIT,  
2 3/4" WIDE,  
35 1/4" HIGH**



**MODEL**

**JFLUTELEGSS**

- Trimmable.

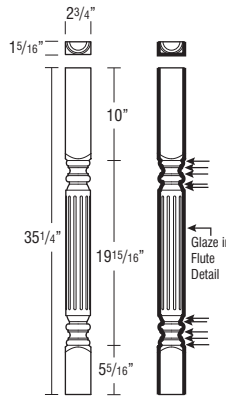

**Finish Techniques**

Distressing	Heirlooming
	•

**Species Availability (Wood)**

Alder	Rustic Alder	Cherry	Hickory	Maple	Oak
•	Alder	•		•	•

**Species Availability (All Laminates)**

High Gloss box color	Horiz. Grain on Maple box color	Vert. Grain on Maple box color	Vert. Grain on Cherry box color	Vert. Grain on Hickory	Vert. Grain on Oak box color	Thermofoil box color
-------------------------	---------------------------------------	--------------------------------------	---------------------------------------	---------------------------	------------------------------------	-------------------------

**CLASSIC FLUTED LEG,  
35 1/4" HIGH**



**JFLUTELEG**

- Trimmable.

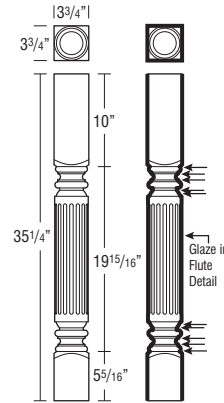

**Finish Techniques**

Distressing	Heirlooming
	•

**Species Availability (Wood)**

Alder	Rustic Alder	Cherry	Hickory	Maple	Oak
•	Alder	•		•	•

**Species Availability (All Laminates)**

High Gloss box color	Horiz. Grain on Maple box color	Vert. Grain on Maple box color	Vert. Grain on Cherry box color	Vert. Grain on Hickory	Vert. Grain on Oak box color	Thermofoil box color
-------------------------	---------------------------------------	--------------------------------------	---------------------------------------	---------------------------	------------------------------------	-------------------------

Finished edges indicated by bold lines on side view drawings.  
Glazed edges indicated by arrows on side view drawings.

**DESCRIPTION**

**MODEL**

**CLASSIC FLUTED LEG,  
42 1/4" HIGH**



**JFLUTELEG**

- Trimable.

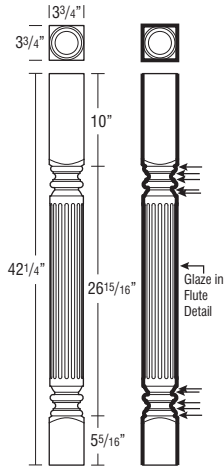

**Finish Techniques**

Distressing	Heirlooming
	•

**Species Availability (Wood)**

Alder	Rustic Alder	Cherry	Hickory	Maple	Oak
•	Alder	•		•	•

**Species Availability (All Laminates)**

High Gloss box color	Horiz. Grain on Maple box color	Vert. Grain on Maple box color	Vert. Grain on Cherry box color	Vert. Grain on Hickory box color	Vert. Grain on Oak box color	Thermofoil box color
-------------------------	---------------------------------------	--------------------------------------	---------------------------------------	--	------------------------------------	-------------------------

**CLASSIC FLUTED LEG,  
5" WIDE, 35 1/4" HIGH**



**JFLUTELEG**

- Trimable.

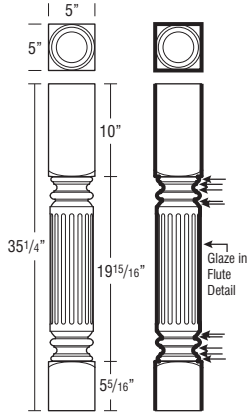

**Finish Techniques**

Distressing	Heirlooming
	•

**Species Availability (Wood)**

Alder	Rustic Alder	Cherry	Hickory	Maple	Oak
•	Alder	•		•	•

**Species Availability (All Laminates)**

High Gloss box color	Horiz. Grain on Maple box color	Vert. Grain on Maple box color	Vert. Grain on Cherry box color	Vert. Grain on Hickory box color	Vert. Grain on Oak box color	Thermofoil box color
-------------------------	---------------------------------------	--------------------------------------	---------------------------------------	--	------------------------------------	-------------------------

**DESCRIPTION**

**MODEL**

**FRENCH COUNTRY LEG,  
35 1/4" HIGH**



**JFRNCNTYLEG**

- Trimable.

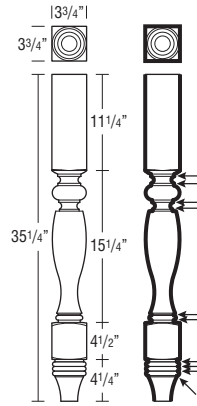

**Finish Techniques**

Distressing	Heirlooming
	•

**Species Availability (Wood)**

Alder	Rustic Alder	Cherry	Hickory	Maple	Oak
•	Alder	•		•	•

**Species Availability (All Laminates)**

High Gloss box color	Horiz. Grain on Maple box color	Vert. Grain on Maple box color	Vert. Grain on Cherry box color	Vert. Grain on Hickory box color	Vert. Grain on Oak box color	Thermofoil box color
-------------------------	---------------------------------------	--------------------------------------	---------------------------------------	--	------------------------------------	-------------------------

**FRENCH COUNTRY LEG,  
42 1/4" HIGH**



**JFRNCNTYLEG**

- Trimable.

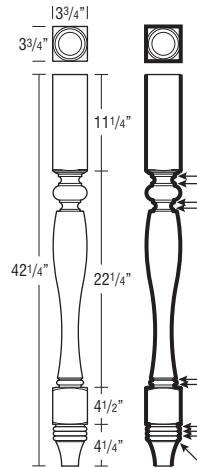

**Finish Techniques**

Distressing	Heirlooming
	•

**Species Availability (Wood)**

Alder	Rustic Alder	Cherry	Hickory	Maple	Oak
•	Alder	•		•	•

**Species Availability (All Laminates)**

High Gloss box color	Horiz. Grain on Maple box color	Vert. Grain on Maple box color	Vert. Grain on Cherry box color	Vert. Grain on Hickory box color	Vert. Grain on Oak box color	Thermofoil box color
-------------------------	---------------------------------------	--------------------------------------	---------------------------------------	--	------------------------------------	-------------------------

Finished edges indicated by bold lines on side view drawings.  
Glazed edges indicated by arrows on side view drawings.

DESCRIPTION

MODEL

**FRENCH COUNTRY LEG, 5" WIDE, 35 1/4" HIGH**



**JFRNCNTYLEGL**

• Trimmable.

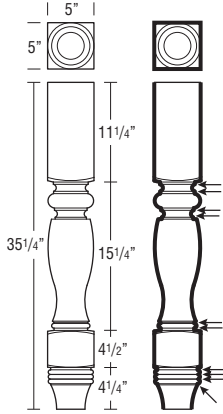

**Finish Techniques**

Distressing	Heirlooming
	•

**Species Availability (Wood)**

Alder	Rustic Alder	Cherry	Hickory	Maple	Oak
•	Alder	•		•	•

**Species Availability (All Laminates)**

High Gloss box color	Horiz. Grain on Maple box color	Vert. Grain on Maple box color	Vert. Grain on Cherry box color	Vert. Grain on Hickory	Vert. Grain on Oak box color	Thermofoil box color
----------------------	---------------------------------	--------------------------------	---------------------------------	------------------------	------------------------------	----------------------

DESCRIPTION

MODEL

**ISLAND LEG, 4-SIDED, 35 1/4" HIGH**



**4SISLEGL**

• Trimmable.

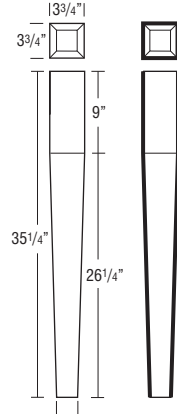

**Finish Techniques**

Distressing	Heirlooming
	•

**Species Availability (Wood)**

Alder	Rustic Alder	Cherry	Hickory	Maple	Oak
•	Alder	•		•	•

**Species Availability (All Laminates)**

High Gloss box color	Horiz. Grain on Maple box color	Vert. Grain on Maple box color	Vert. Grain on Cherry box color	Vert. Grain on Hickory	Vert. Grain on Oak box color	Thermofoil box color
----------------------	---------------------------------	--------------------------------	---------------------------------	------------------------	------------------------------	----------------------

Taper 4 Sides

**ISLAND LEG, 2-SIDED, 35 1/4" HIGH**



**2SISLEGL**

• Trimmable.

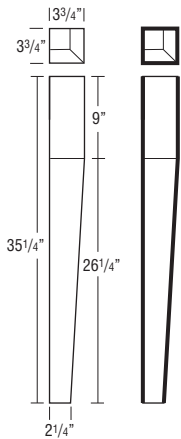

**Finish Techniques**

Distressing	Heirlooming
	•

**Species Availability (Wood)**

Alder	Rustic Alder	Cherry	Hickory	Maple	Oak
•	Alder	•		•	•

**Species Availability (All Laminates)**

High Gloss box color	Horiz. Grain on Maple box color	Vert. Grain on Maple box color	Vert. Grain on Cherry box color	Vert. Grain on Hickory	Vert. Grain on Oak box color	Thermofoil box color
----------------------	---------------------------------	--------------------------------	---------------------------------	------------------------	------------------------------	----------------------

Taper 2 Sides

**METRO BAR COLUMN, 40 5/8" HIGH**



**METBARCOLUMN**

• Trimmable.

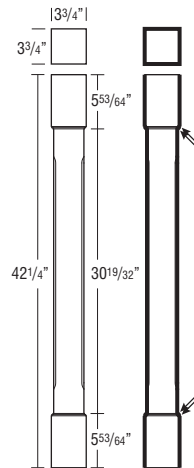

**Finish Techniques**

Distressing	Heirlooming
	•

**Species Availability (Wood)**

Alder	Rustic Alder	Cherry	Hickory	Maple	Oak
•	Alder	•		•	•

**Species Availability (All Laminates)**

High Gloss box color	Horiz. Grain on Maple box color	Vert. Grain on Maple box color	Vert. Grain on Cherry box color	Vert. Grain on Hickory	Vert. Grain on Oak box color	Thermofoil box color
----------------------	---------------------------------	--------------------------------	---------------------------------	------------------------	------------------------------	----------------------

Finished edges indicated by bold lines on side view drawings.  
Glazed edges indicated by arrows on side view drawings.

**DESCRIPTION**

**MODEL**

**METRO ISLAND COLUMN,  
34 5/8" HIGH**



**METISLCOLUMN**

- Trimable.
- Leg is designed with three pieces joined together.

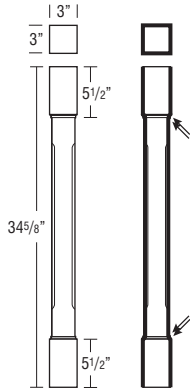

**Finish Techniques**

Distressing	Heirlooming
	•

**Species Availability (Wood)**

Alder	Rustic Alder	Cherry	Hickory	Maple	Oak
•	Alder	•		•	•

**Species Availability (All Laminates)**

High Gloss	Horiz. Grain on Maple	Vert. Grain on Maple	Vert. Grain on Cherry	Vert. Grain on Hickory	Vert. Grain on Oak	Thermofoil
box color	box color	box color	box color		box color	box color

**DESCRIPTION**

**MODEL**

**QUEEN ANNE LEG,  
42 1/4" HIGH**



**JQUNANNELEG**

- Trimable.

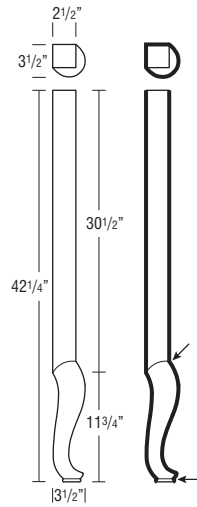

**Finish Techniques**

Distressing	Heirlooming
	•

**Species Availability (Wood)**

Alder	Rustic Alder	Cherry	Hickory	Maple	Oak
•	Alder	•		•	•

**Species Availability (All Laminates)**

High Gloss	Horiz. Grain on Maple	Vert. Grain on Maple	Vert. Grain on Cherry	Vert. Grain on Hickory	Vert. Grain on Oak	Thermofoil
box color	box color	box color	box color		box color	box color

**MISSION LEG,  
34 1/2" HIGH**



**DLEGMSSION**

- Trimable.

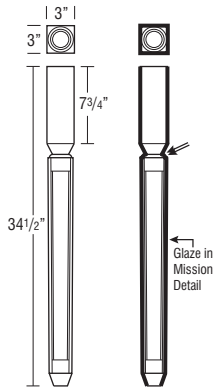

**Finish Techniques**

Distressing	Heirlooming
	•

**Species Availability (Wood)**

Alder	Rustic Alder	Cherry	Hickory	Maple	Oak
•	Alder	•		•	•

**Species Availability (All Laminates)**

High Gloss	Horiz. Grain on Maple	Vert. Grain on Maple	Vert. Grain on Cherry	Vert. Grain on Hickory	Vert. Grain on Oak	Thermofoil
box color	box color	box color	box color		box color	box color

**REED LEG, 34 1/2" HIGH**



**RDLEG**

- Trimable.

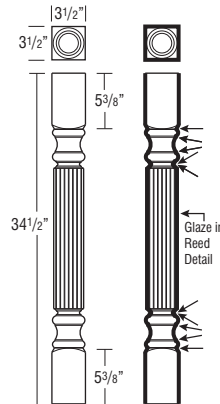

**Finish Techniques**

Distressing	Heirlooming
	•

**Species Availability (Wood)**

Alder	Rustic Alder	Cherry	Hickory	Maple	Oak
•	Alder	•		•	•

**Species Availability (All Laminates)**

High Gloss	Horiz. Grain on Maple	Vert. Grain on Maple	Vert. Grain on Cherry	Vert. Grain on Hickory	Vert. Grain on Oak	Thermofoil
box color	box color	box color	box color		box color	box color

Finished edges indicated by bold lines on side view drawings.  
Glazed edges indicated by arrows on side view drawings.

DESCRIPTION

MODEL

REED LEG, 40 1/2" HIGH



JRDLEGT

- Trimmable.

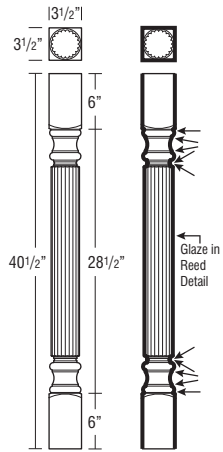

Finish Techniques

Distressing	Heirlooming
	•

Species Availability (Wood)

Alder	Rustic Alder	Cherry	Hickory	Maple	Oak
•	Alder	•		•	•

Species Availability (All Laminates)

High Gloss box color	Horiz. Grain on Maple box color	Vert. Grain on Maple box color	Vert. Grain on Cherry box color	Vert. Grain on Hickory	Vert. Grain on Oak box color	Thermofoil box color
----------------------	---------------------------------	--------------------------------	---------------------------------	------------------------	------------------------------	----------------------

REED LEG, 5" WIDE, 34 1/2" HIGH



JRDLEGL

- Trimmable.

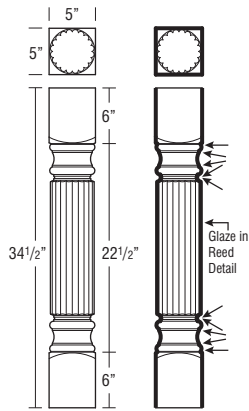

Finish Techniques

Distressing	Heirlooming
	•

Species Availability (Wood)

Alder	Rustic Alder	Cherry	Hickory	Maple	Oak
•	Alder	•		•	•

Species Availability (All Laminates)

High Gloss box color	Horiz. Grain on Maple box color	Vert. Grain on Maple box color	Vert. Grain on Cherry box color	Vert. Grain on Hickory	Vert. Grain on Oak box color	Thermofoil box color
----------------------	---------------------------------	--------------------------------	---------------------------------	------------------------	------------------------------	----------------------

DESCRIPTION

MODEL

ROMAN WEAVE LEG, 35 1/4" HIGH



JWEAVELEG

- Trimmable.

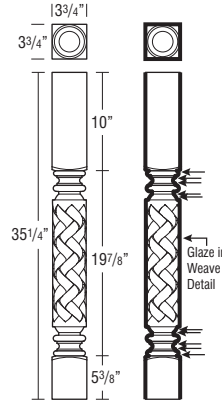

Finish Techniques

Distressing	Heirlooming
	•

Species Availability (Wood)

Alder	Rustic Alder	Cherry	Hickory	Maple	Oak
•	Alder	•		•	•

Species Availability (All Laminates)

High Gloss box color	Horiz. Grain on Maple box color	Vert. Grain on Maple box color	Vert. Grain on Cherry box color	Vert. Grain on Hickory	Vert. Grain on Oak box color	Thermofoil box color
----------------------	---------------------------------	--------------------------------	---------------------------------	------------------------	------------------------------	----------------------

ROMAN WEAVE LEG, 42 1/4" HIGH



JWEAVELEGT

- Trimmable.

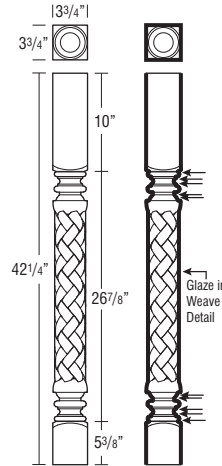

Finish Techniques

Distressing	Heirlooming
	•

Species Availability (Wood)

Alder	Rustic Alder	Cherry	Hickory	Maple	Oak
•	Alder	•		•	•

Species Availability (All Laminates)

High Gloss box color	Horiz. Grain on Maple box color	Vert. Grain on Maple box color	Vert. Grain on Cherry box color	Vert. Grain on Hickory	Vert. Grain on Oak box color	Thermofoil box color
----------------------	---------------------------------	--------------------------------	---------------------------------	------------------------	------------------------------	----------------------

Finished edges indicated by bold lines on side view drawings.  
Glazed edges indicated by arrows on side view drawings.



**DESCRIPTION**

**MODEL**

**ROMAN WEAVE LEG,  
5" WIDE, 35 1/4" HIGH**



**JWEAVELEGL**

- Trimtable.

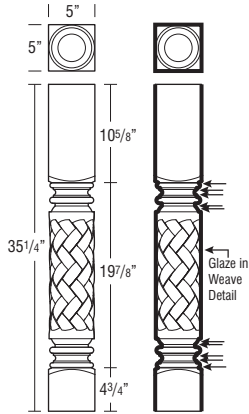

**Finish Techniques**

Distressing	Heirlooming
	•

**Species Availability (Wood)**

Alder	Rustic Alder	Cherry	Hickory	Maple	Oak
•	Alder	•		•	•

**Species Availability (All Laminates)**

High Gloss box color	Horiz. Grain on Maple box color	Vert. Grain on Maple box color	Vert. Grain on Cherry box color	Vert. Grain on Hickory	Vert. Grain on Oak box color	Thermofoil box color
-------------------------	---------------------------------------	--------------------------------------	---------------------------------------	---------------------------	------------------------------------	-------------------------

**DESCRIPTION**

**MODEL**

**SMALL CLASSIC ROPE  
LEG SPLIT,  
2 3/4" WIDE,  
35 1/4" HIGH**



**JROPELEGSS**

- Trimtable.

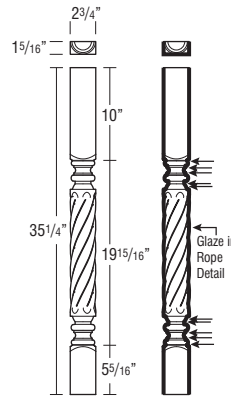

**Finish Techniques**

Distressing	Heirlooming
	•

**Species Availability (Wood)**

Alder	Rustic Alder	Cherry	Hickory	Maple	Oak
•	Alder	•		•	•

**Species Availability (All Laminates)**

High Gloss box color	Horiz. Grain on Maple box color	Vert. Grain on Maple box color	Vert. Grain on Cherry box color	Vert. Grain on Hickory	Vert. Grain on Oak box color	Thermofoil box color
-------------------------	---------------------------------------	--------------------------------------	---------------------------------------	---------------------------	------------------------------------	-------------------------

**SMALL CLASSIC ROPE  
LEG, 2 3/4" WIDE,  
35 1/4" HIGH**



**JROPELEGS**

- Trimtable.

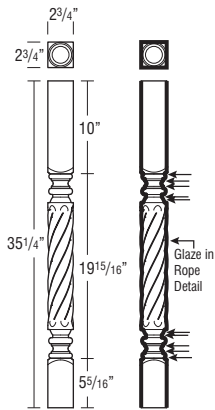

**Finish Techniques**

Distressing	Heirlooming
	•

**Species Availability (Wood)**

Alder	Rustic Alder	Cherry	Hickory	Maple	Oak
•	Alder	•		•	•

**Species Availability (All Laminates)**

High Gloss box color	Horiz. Grain on Maple box color	Vert. Grain on Maple box color	Vert. Grain on Cherry box color	Vert. Grain on Hickory	Vert. Grain on Oak box color	Thermofoil box color
-------------------------	---------------------------------------	--------------------------------------	---------------------------------------	---------------------------	------------------------------------	-------------------------

**CLASSIC ROPE LEG,  
35 1/4" HIGH**



**JROPELEG**

- Trimtable.

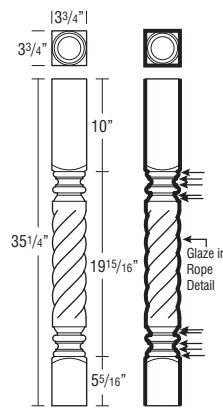

**Finish Techniques**

Distressing	Heirlooming
	•

**Species Availability (Wood)**

Alder	Rustic Alder	Cherry	Hickory	Maple	Oak
•	Alder	•		•	•

**Species Availability (All Laminates)**

High Gloss box color	Horiz. Grain on Maple box color	Vert. Grain on Maple box color	Vert. Grain on Cherry box color	Vert. Grain on Hickory	Vert. Grain on Oak box color	Thermofoil box color
-------------------------	---------------------------------------	--------------------------------------	---------------------------------------	---------------------------	------------------------------------	-------------------------

Finished edges indicated by bold lines in side view drawings.  
Glazed edges indicated by arrows in side view drawings.

DESCRIPTION

MODEL

**CLASSIC ROPE LEG,  
42 1/4" HIGH**



**JROPELEG**

- Trimmable.

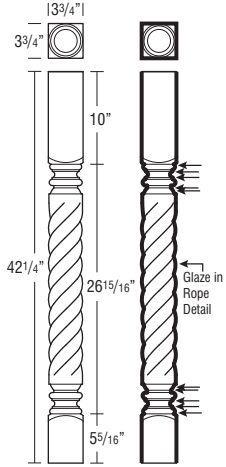

**Finish Techniques**

Distressing	Heirlooming
	•

**Species Availability (Wood)**

Alder	Rustic Alder	Cherry	Hickory	Maple	Oak
•	Alder	•		•	•

**Species Availability (All Laminates)**

High Gloss box color	Horiz. Grain on Maple box color	Vert. Grain on Maple box color	Vert. Grain on Cherry box color	Vert. Grain on Hickory	Vert. Grain on Oak box color	Thermofoil box color
----------------------	---------------------------------	--------------------------------	---------------------------------	------------------------	------------------------------	----------------------

**CLASSIC ROPE LEG,  
5" WIDE, 35 1/4" HIGH**



**JROPELEG**

- Trimmable.

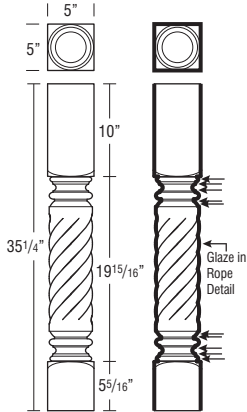

**Finish Techniques**

Distressing	Heirlooming
	•

**Species Availability (Wood)**

Alder	Rustic Alder	Cherry	Hickory	Maple	Oak
•	Alder	•		•	•

**Species Availability (All Laminates)**

High Gloss box color	Horiz. Grain on Maple box color	Vert. Grain on Maple box color	Vert. Grain on Cherry box color	Vert. Grain on Hickory	Vert. Grain on Oak box color	Thermofoil box color
----------------------	---------------------------------	--------------------------------	---------------------------------	------------------------	------------------------------	----------------------

DESCRIPTION

MODEL

**SMALL SPOOL LEG,  
2 3/4" WIDE,  
35 1/4" HIGH**



**JSPLEGS**

- Trimmable.

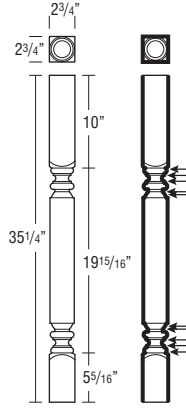

**Finish Techniques**

Distressing	Heirlooming
	•

**Species Availability (Wood)**

Alder	Rustic Alder	Cherry	Hickory	Maple	Oak
•	Alder	•		•	•

**Species Availability (All Laminates)**

High Gloss box color	Horiz. Grain on Maple box color	Vert. Grain on Maple box color	Vert. Grain on Cherry box color	Vert. Grain on Hickory	Vert. Grain on Oak box color	Thermofoil box color
----------------------	---------------------------------	--------------------------------	---------------------------------	------------------------	------------------------------	----------------------

**SMALL SPOOL LEG  
SPLIT, 2 3/4" WIDE,  
35 1/4" HIGH**



**JSPLEGS**

- Trimmable.

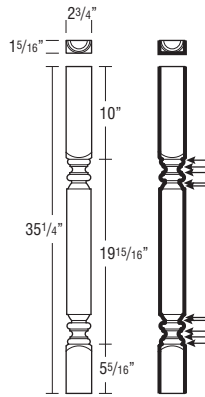

**Finish Techniques**

Distressing	Heirlooming
	•

**Species Availability (Wood)**

Alder	Rustic Alder	Cherry	Hickory	Maple	Oak
•	Alder	•		•	•

**Species Availability (All Laminates)**

High Gloss box color	Horiz. Grain on Maple box color	Vert. Grain on Maple box color	Vert. Grain on Cherry box color	Vert. Grain on Hickory	Vert. Grain on Oak box color	Thermofoil box color
----------------------	---------------------------------	--------------------------------	---------------------------------	------------------------	------------------------------	----------------------

Finished edges indicated by bold lines on side view drawings.  
Glazed edges indicated by arrows on side view drawings.

**DESCRIPTION**

**MODEL**

**SPOOL LEG,  
34 1/2" HIGH**



**SPLEG**

- Trimtable.

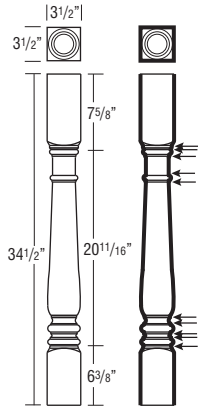

**Finish Techniques**

Distressing	Heirlooming
	•

**Species Availability (Wood)**

Alder	Rustic Alder	Cherry	Hickory	Maple	Oak
•	Alder	•		•	•

**Species Availability (All Laminates)**

High Gloss box color	Horiz. Grain on Maple box color	Vert. Grain on Maple box color	Vert. Grain on Cherry box color	Vert. Grain on Hickory	Vert. Grain on Oak box color	Thermofoil box color
-------------------------	---------------------------------------	--------------------------------------	---------------------------------------	---------------------------	------------------------------------	-------------------------

**SPOOL LEG,  
40 1/2" HIGH**



**JSPLEGT**

- Trimtable.

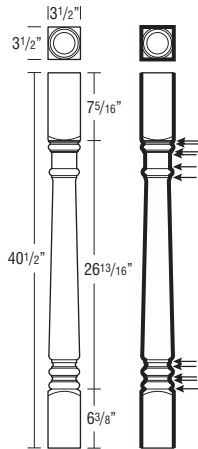

**Finish Techniques**

Distressing	Heirlooming
	•

**Species Availability (Wood)**

Alder	Rustic Alder	Cherry	Hickory	Maple	Oak
•	Alder	•		•	•

**Species Availability (All Laminates)**

High Gloss box color	Horiz. Grain on Maple box color	Vert. Grain on Maple box color	Vert. Grain on Cherry box color	Vert. Grain on Hickory	Vert. Grain on Oak box color	Thermofoil box color
-------------------------	---------------------------------------	--------------------------------------	---------------------------------------	---------------------------	------------------------------------	-------------------------

**SQUARE ISLAND  
LEG SPLIT,  
35 1/4" HIGH**



**JSQISLEG3S**

- Trimtable.

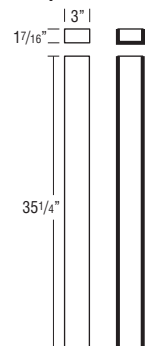

**Finish Techniques**

Distressing	Heirlooming
	•

**Species Availability (Wood)**

Alder	Rustic Alder	Cherry	Hickory	Maple	Oak
•	Alder	•		•	•

**Species Availability (All Laminates)**

High Gloss box color	Horiz. Grain on Maple box color	Vert. Grain on Maple box color	Vert. Grain on Cherry box color	Vert. Grain on Hickory	Vert. Grain on Oak box color	Thermofoil box color
-------------------------	---------------------------------------	--------------------------------------	---------------------------------------	---------------------------	------------------------------------	-------------------------

**DESCRIPTION**

**MODEL**

**SQUARE ISLAND LEG,  
3" x 3", 35 1/4" HIGH**



**JSQISLEG3**

- Trimtable.

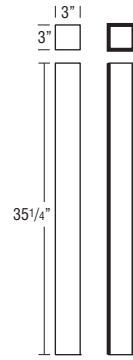

**Finish Techniques**

Distressing	Heirlooming
	•

**Species Availability (Wood)**

Alder	Rustic Alder	Cherry	Hickory	Maple	Oak
•	Alder	•		•	•

**Species Availability (All Laminates)**

High Gloss box color	Horiz. Grain on Maple box color	Vert. Grain on Maple box color	Vert. Grain on Cherry box color	Vert. Grain on Hickory	Vert. Grain on Oak box color	Thermofoil box color
-------------------------	---------------------------------------	--------------------------------------	---------------------------------------	---------------------------	------------------------------------	-------------------------

**SQUARE ISLAND LEG,  
4" x 4", 35 1/4" HIGH**



**JSQISLEG4**

- Trimtable.

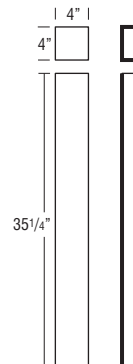

**Finish Techniques**

Distressing	Heirlooming
	•

**Species Availability (Wood)**

Alder	Rustic Alder	Cherry	Hickory	Maple	Oak
•	Alder	•		•	•

**Species Availability (All Laminates)**

High Gloss box color	Horiz. Grain on Maple box color	Vert. Grain on Maple box color	Vert. Grain on Cherry box color	Vert. Grain on Hickory	Vert. Grain on Oak box color	Thermofoil box color
-------------------------	---------------------------------------	--------------------------------------	---------------------------------------	---------------------------	------------------------------------	-------------------------

**SQUARE ISLAND LEG,  
6" x 6", 35 1/4" HIGH**



**JSQISLEG6**

- Trimtable.

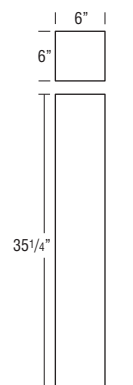

**Finish Techniques**

Distressing	Heirlooming
	•

**Species Availability (Wood)**

Alder	Rustic Alder	Cherry	Hickory	Maple	Oak
•	Alder	•		•	•

**Species Availability (All Laminates)**

High Gloss box color	Horiz. Grain on Maple box color	Vert. Grain on Maple box color	Vert. Grain on Cherry box color	Vert. Grain on Hickory	Vert. Grain on Oak box color	Thermofoil box color
-------------------------	---------------------------------------	--------------------------------------	---------------------------------------	---------------------------	------------------------------------	-------------------------

Finished edges indicated by bold lines on side view drawings.  
Glazed edges indicated by arrows on side view drawings.

DESCRIPTION

MODEL

**SQUARE BAR LEG  
SPLIT, 42 1/4" HIGH**



**JSQBARLEG3S**

• Trimmable.

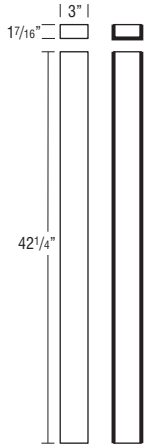

**Finish Techniques**

Distressing	Heirlooming
	•

**Species Availability (Wood)**

Alder	Rustic Alder	Cherry	Hickory	Maple	Oak
•	Alder	•		•	•

**Species Availability (All Laminates)**

High Gloss box color	Horiz. Grain on Maple box color	Vert. Grain on Maple box color	Vert. Grain on Cherry box color	Vert. Grain on Hickory	Vert. Grain on Oak box color	Thermofoil box color
-------------------------	---------------------------------------	--------------------------------------	---------------------------------------	---------------------------	------------------------------------	-------------------------

DESCRIPTION

MODEL

**SQUARE BAR LEG,  
6" x 6", 42 1/4" HIGH**



**JSQBARLEG6**

• Trimmable.

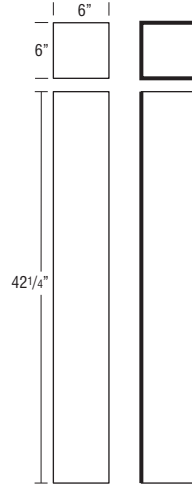

**Finish Techniques**

Distressing	Heirlooming
	•

**Species Availability (Wood)**

Alder	Rustic Alder	Cherry	Hickory	Maple	Oak
•	Alder	•		•	•

**Species Availability (All Laminates)**

High Gloss box color	Horiz. Grain on Maple box color	Vert. Grain on Maple box color	Vert. Grain on Cherry box color	Vert. Grain on Hickory	Vert. Grain on Oak box color	Thermofoil box color
-------------------------	---------------------------------------	--------------------------------------	---------------------------------------	---------------------------	------------------------------------	-------------------------

**SQUARE BAR LEG,  
3" x 3", 42 1/4" HIGH**



**JSQBARLEG3**

• Trimmable.

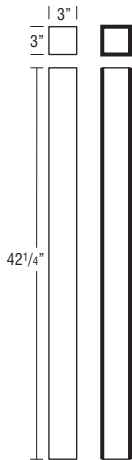

**Finish Techniques**

Distressing	Heirlooming
	•

**Species Availability (Wood)**

Alder	Rustic Alder	Cherry	Hickory	Maple	Oak
•	Alder	•		•	•

**Species Availability (All Laminates)**

High Gloss box color	Horiz. Grain on Maple box color	Vert. Grain on Maple box color	Vert. Grain on Cherry box color	Vert. Grain on Hickory	Vert. Grain on Oak box color	Thermofoil box color
-------------------------	---------------------------------------	--------------------------------------	---------------------------------------	---------------------------	------------------------------------	-------------------------

**TULIP LEG,  
34 1/2" HIGH**



**JTULIPLEG**

• Trimmable.

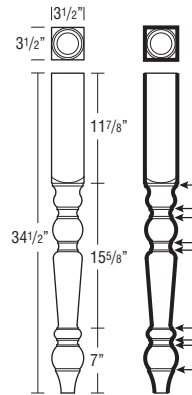

**Finish Techniques**

Distressing	Heirlooming
	•

**Species Availability (Wood)**

Alder	Rustic Alder	Cherry	Hickory	Maple	Oak
•	Alder	•		•	•

**Species Availability (All Laminates)**

High Gloss box color	Horiz. Grain on Maple box color	Vert. Grain on Maple box color	Vert. Grain on Cherry box color	Vert. Grain on Hickory	Vert. Grain on Oak box color	Thermofoil box color
-------------------------	---------------------------------------	--------------------------------------	---------------------------------------	---------------------------	------------------------------------	-------------------------

**SQUARE BAR LEG,  
4" x 4", 42 1/4" HIGH**



**JSQBARLEG4**

• Trimmable.

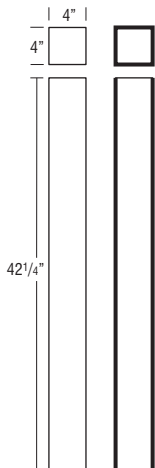

**Finish Techniques**

Distressing	Heirlooming
	•

**Species Availability (Wood)**

Alder	Rustic Alder	Cherry	Hickory	Maple	Oak
•	Alder	•		•	•

**Species Availability (All Laminates)**

High Gloss box color	Horiz. Grain on Maple box color	Vert. Grain on Maple box color	Vert. Grain on Cherry box color	Vert. Grain on Hickory	Vert. Grain on Oak box color	Thermofoil box color
-------------------------	---------------------------------------	--------------------------------------	---------------------------------------	---------------------------	------------------------------------	-------------------------

Finished edges indicated by bold lines on side view drawings.  
Glazed edges indicated by arrows on side view drawings.

**DESCRIPTION**

**MODEL**

**TULIP LEG,  
40 1/2" HIGH**



**JTULPLEGT**

- Trimable.

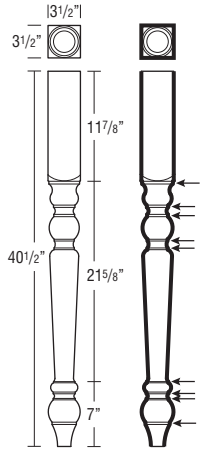

**Finish Techniques**

Distressing	Heirloom
	•

**Species Availability (Wood)**

Alder	Rustic Alder	Cherry	Hickory	Maple	Oak
•	Alder	•		•	•

**Species Availability (All Laminates)**

High Gloss box color	Horiz. Grain on Maple box color	Vert. Grain on Maple box color	Vert. Grain on Cherry box color	Vert. Grain on Hickory	Vert. Grain on Oak box color	Thermofoil box color
-------------------------	---------------------------------------	--------------------------------------	---------------------------------------	---------------------------	------------------------------------	-------------------------

**DESCRIPTION**

**MODEL**

**URN LEG,  
42 1/4" HIGH**



**JURNLEGT**

- Trimable.

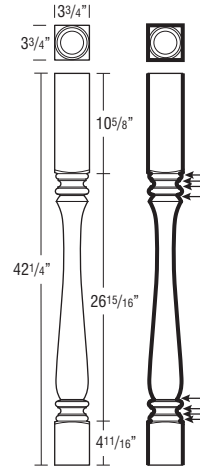

**Finish Techniques**

Distressing	Heirloom
	•

**Species Availability (Wood)**

Alder	Rustic Alder	Cherry	Hickory	Maple	Oak
•	Alder	•		•	•

**Species Availability (All Laminates)**

High Gloss box color	Horiz. Grain on Maple box color	Vert. Grain on Maple box color	Vert. Grain on Cherry box color	Vert. Grain on Hickory	Vert. Grain on Oak box color	Thermofoil box color
-------------------------	---------------------------------------	--------------------------------------	---------------------------------------	---------------------------	------------------------------------	-------------------------

**URN LEG,  
35 1/4" HIGH**



**JURNLEG**

- Trimable.

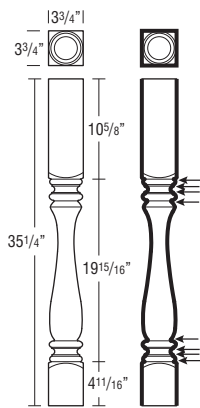

**Finish Techniques**

Distressing	Heirloom
	•

**Species Availability (Wood)**

Alder	Rustic Alder	Cherry	Hickory	Maple	Oak
•	Alder	•		•	•

**Species Availability (All Laminates)**

High Gloss box color	Horiz. Grain on Maple box color	Vert. Grain on Maple box color	Vert. Grain on Cherry box color	Vert. Grain on Hickory	Vert. Grain on Oak box color	Thermofoil box color
-------------------------	---------------------------------------	--------------------------------------	---------------------------------------	---------------------------	------------------------------------	-------------------------

**URN LEG, 5" WIDE,  
35 1/4" HIGH**



**JURNLEGL**

- Trimable.

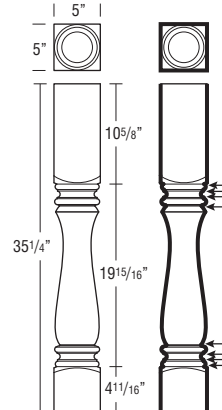

**Finish Techniques**

Distressing	Heirloom
	•

**Species Availability (Wood)**

Alder	Rustic Alder	Cherry	Hickory	Maple	Oak
•	Alder	•		•	•

**Species Availability (All Laminates)**

High Gloss box color	Horiz. Grain on Maple box color	Vert. Grain on Maple box color	Vert. Grain on Cherry box color	Vert. Grain on Hickory	Vert. Grain on Oak box color	Thermofoil box color
-------------------------	---------------------------------------	--------------------------------------	---------------------------------------	---------------------------	------------------------------------	-------------------------

**ABBE FOOT, 4" HIGH**



**ABFOOT**

- Recommended for applications without toekicks.

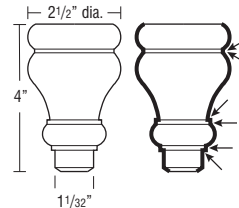

**Finish Techniques**

Distressing	Heirloom
	•

**Species Availability (Wood)**

Alder	Rustic Alder	Cherry	Hickory	Maple	Oak
•	Alder	•		•	•

**Species Availability (All Laminates)**

High Gloss box color	Horiz. Grain on Maple box color	Vert. Grain on Maple box color	Vert. Grain on Cherry box color	Vert. Grain on Hickory	Vert. Grain on Oak box color	Thermofoil box color
-------------------------	---------------------------------------	--------------------------------------	---------------------------------------	---------------------------	------------------------------------	-------------------------

Finished edges indicated by bold lines on side view drawings.  
Glazed edges indicated by arrows on side view drawings.

**DESCRIPTION**

**MODEL**

**FRENCH LEG, 6" HIGH**



**FRNLG**

- Trimmable.

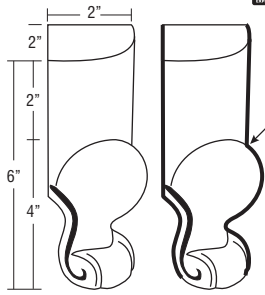

**Finish Techniques**

Distressing	Heirlooming
	•

**Species Availability (Wood)**

Alder	Rustic Alder	Cherry	Hickory	Maple	Oak
•	•	•		•	

**Species Availability (All Laminates)**

High Gloss box color	Horiz. Grain on Maple box color	Vert. Grain on Maple box color	Vert. Grain on Cherry box color	Vert. Grain on Hickory	Vert. Grain on Oak	Thermofoil box color
----------------------	---------------------------------	--------------------------------	---------------------------------	------------------------	--------------------	----------------------

**ACANTHUS FOOT, 4 1/2" HIGH**



**JACANFOOT**

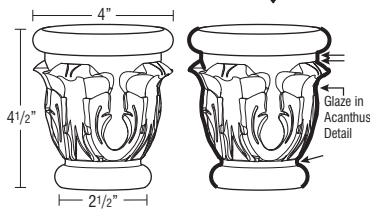

**Finish Techniques**

Distressing	Heirlooming
	•

**Species Availability (Wood)**

Alder	Rustic Alder	Cherry	Hickory	Maple	Oak
•	•	•		•	•

**Species Availability (All Laminates)**

High Gloss box color	Horiz. Grain on Maple box color	Vert. Grain on Maple box color	Vert. Grain on Cherry box color	Vert. Grain on Hickory	Vert. Grain on Oak	Thermofoil box color
----------------------	---------------------------------	--------------------------------	---------------------------------	------------------------	--------------------	----------------------

**COSMO FOOT, 4" HIGH**



**JCOSFOOT**

- Recommended for applications without toekicks.

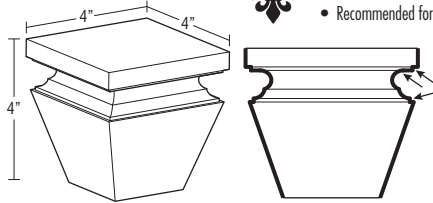

**Finish Techniques**

Distressing	Heirlooming
	•

**Species Availability (Wood)**

Alder	Rustic Alder	Cherry	Hickory	Maple	Oak
•	•	•		•	•

**Species Availability (All Laminates)**

High Gloss box color	Horiz. Grain on Maple box color	Vert. Grain on Maple box color	Vert. Grain on Cherry box color	Vert. Grain on Hickory	Vert. Grain on Oak	Thermofoil box color
----------------------	---------------------------------	--------------------------------	---------------------------------	------------------------	--------------------	----------------------

**CRAFTSMAN FOOT, 4 1/2" HIGH**



**JCRAFTFOOT**

- Trimmable.

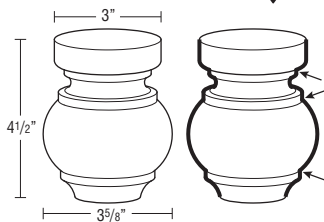

**Finish Techniques**

Distressing	Heirlooming
	•

**Species Availability (Wood)**

Alder	Rustic Alder	Cherry	Hickory	Maple	Oak
•	•	•		•	•

**Species Availability (All Laminates)**

High Gloss box color	Horiz. Grain on Maple box color	Vert. Grain on Maple box color	Vert. Grain on Cherry box color	Vert. Grain on Hickory	Vert. Grain on Oak	Thermofoil box color
----------------------	---------------------------------	--------------------------------	---------------------------------	------------------------	--------------------	----------------------

**DESCRIPTION**

**MODEL**

**FRENCH COUNTRY FOOT, 6" HIGH**



**JFRNCNTYFOOT**

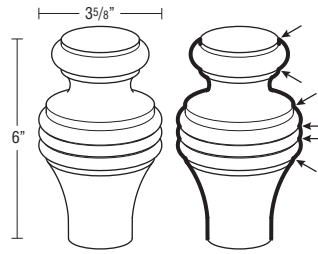

**Finish Techniques**

Distressing	Heirlooming
	•

**Species Availability (Wood)**

Alder	Rustic Alder	Cherry	Hickory	Maple	Oak
•	•	•		•	•

**Species Availability (All Laminates)**

High Gloss box color	Horiz. Grain on Maple box color	Vert. Grain on Maple box color	Vert. Grain on Cherry box color	Vert. Grain on Hickory	Vert. Grain on Oak	Thermofoil box color
----------------------	---------------------------------	--------------------------------	---------------------------------	------------------------	--------------------	----------------------

**MADLINE FOOT, 4 1/2" HIGH**



**JMADEFOOT**

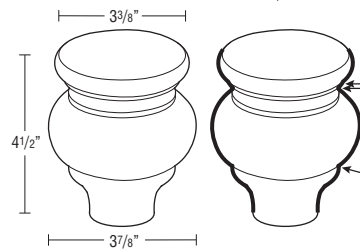

**Finish Techniques**

Distressing	Heirlooming
	•

**Species Availability (Wood)**

Alder	Rustic Alder	Cherry	Hickory	Maple	Oak
•	•	•		•	•

**Species Availability (All Laminates)**

High Gloss box color	Horiz. Grain on Maple box color	Vert. Grain on Maple box color	Vert. Grain on Cherry box color	Vert. Grain on Hickory	Vert. Grain on Oak	Thermofoil box color
----------------------	---------------------------------	--------------------------------	---------------------------------	------------------------	--------------------	----------------------

**MADISON FOOT, 6 1/8" HIGH**



**JMADFOOT**

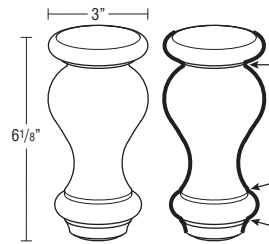

**Finish Techniques**

Distressing	Heirlooming
	•

**Species Availability (Wood)**

Alder	Rustic Alder	Cherry	Hickory	Maple	Oak
•	•	•		•	•

**Species Availability (All Laminates)**

High Gloss box color	Horiz. Grain on Maple box color	Vert. Grain on Maple box color	Vert. Grain on Cherry box color	Vert. Grain on Hickory	Vert. Grain on Oak	Thermofoil box color
----------------------	---------------------------------	--------------------------------	---------------------------------	------------------------	--------------------	----------------------

Finished edges indicated by bold lines on side view drawings.  
Glazed edges indicated by arrows on side view drawings.

**DESCRIPTION**

**MODEL**

**METROPOLITAN FOOT, 4 5/8" HIGH**



**JMETROFOOT**

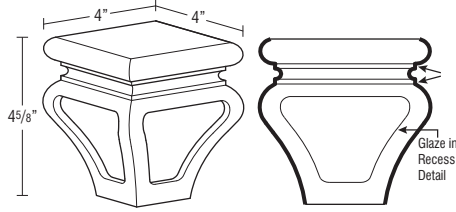

**Finish Techniques**

Distressing	Heirlooming
	•

**Species Availability (Wood)**

Alder	Rustic Alder	Cherry	Hickory	Maple	Oak
•	Alder	•		•	•

**Species Availability (All Laminates)**

High Gloss box color	Horiz. Grain on Maple box color	Vert. Grain on Maple box color	Vert. Grain on Cherry box color	Vert. Grain on Hickory	Vert. Grain on Oak box color	Thermofoil box color
----------------------	---------------------------------	--------------------------------	---------------------------------	------------------------	------------------------------	----------------------

**WEAVE FOOT, 4 1/2" HIGH**



**JWEAVEFOOT**

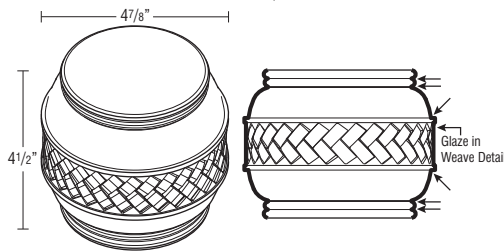

**Finish Techniques**

Distressing	Heirlooming
	•

**Species Availability (Wood)**

Alder	Rustic Alder	Cherry	Hickory	Maple	Oak
•	Alder	•		•	•

**Species Availability (All Laminates)**

High Gloss box color	Horiz. Grain on Maple box color	Vert. Grain on Maple box color	Vert. Grain on Cherry box color	Vert. Grain on Hickory	Vert. Grain on Oak box color	Thermofoil box color
----------------------	---------------------------------	--------------------------------	---------------------------------	------------------------	------------------------------	----------------------

**LARGE SQUARE FOOT, 5" HIGH**



**LGSQFOOT**

• Trimmable.

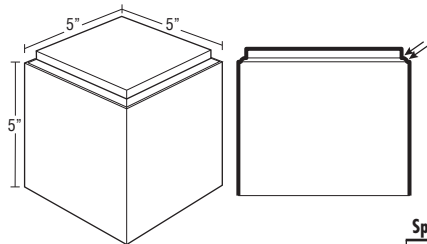

**Finish Techniques**

Distressing	Heirlooming
	•

**Species Availability (Wood)**

Alder	Rustic Alder	Cherry	Hickory	Maple	Oak
•	Alder	•		•	•

**Species Availability (All Laminates)**

High Gloss box color	Horiz. Grain on Maple box color	Vert. Grain on Maple box color	Vert. Grain on Cherry box color	Vert. Grain on Hickory	Vert. Grain on Oak box color	Thermofoil box color
----------------------	---------------------------------	--------------------------------	---------------------------------	------------------------	------------------------------	----------------------

**DESCRIPTION**

**MODEL**

**SQUARE FOOT, 4 1/2" HIGH**



**JSQFOOT**

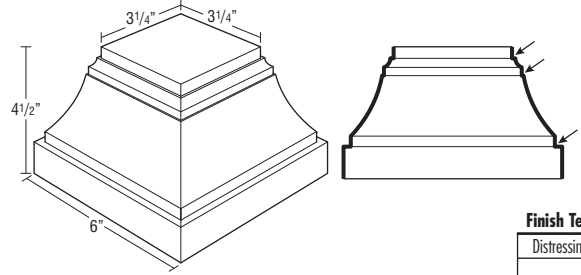

**Finish Techniques**

Distressing	Heirlooming
	•

**Species Availability (Wood)**

Alder	Rustic Alder	Cherry	Hickory	Maple	Oak
•	Alder	•		•	•

**Species Availability (All Laminates)**

High Gloss box color	Horiz. Grain on Maple box color	Vert. Grain on Maple box color	Vert. Grain on Cherry box color	Vert. Grain on Hickory	Vert. Grain on Oak box color	Thermofoil box color
----------------------	---------------------------------	--------------------------------	---------------------------------	------------------------	------------------------------	----------------------

**SQUARE FOOT, SPLIT, 4 1/2" HIGH**



**JSQFOOTS**

• Trimmable.

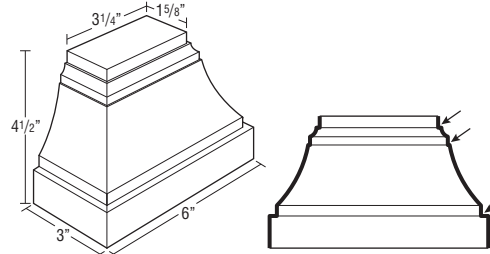

**Finish Techniques**

Distressing	Heirlooming
	•

**Species Availability (Wood)**

Alder	Rustic Alder	Cherry	Hickory	Maple	Oak
•	Alder	•		•	•

**Species Availability (All Laminates)**

High Gloss box color	Horiz. Grain on Maple box color	Vert. Grain on Maple box color	Vert. Grain on Cherry box color	Vert. Grain on Hickory	Vert. Grain on Oak box color	Thermofoil box color
----------------------	---------------------------------	--------------------------------	---------------------------------	------------------------	------------------------------	----------------------

**LILLE FOOT, 4 1/2" HIGH**



**LIFOOT**

• LIFOOT is designed to work with Void Toe Kick Modification (VTK).

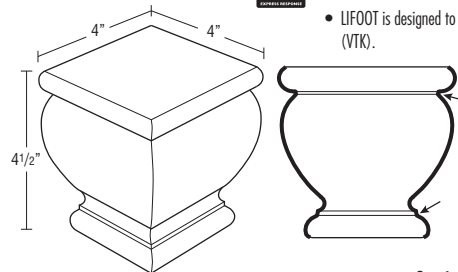

**Finish Techniques**

Distressing	Heirlooming
	•

**Species Availability (Wood)**

Alder	Rustic Alder	Cherry	Hickory	Maple	Oak
•	Alder	•		•	•

**Species Availability (All Laminates)**

High Gloss box color	Horiz. Grain on Maple box color	Vert. Grain on Maple box color	Vert. Grain on Cherry box color	Vert. Grain on Hickory	Vert. Grain on Oak box color	Thermofoil box color
----------------------	---------------------------------	--------------------------------	---------------------------------	------------------------	------------------------------	----------------------

Finished edges indicated by bold lines on side view drawings.  
Glazed edges indicated by arrows on side view drawings.

DESCRIPTION

MODEL

PLINTH BLOCK,  
4 1/2" HIGH



PLBLOCK

• Trimmable.

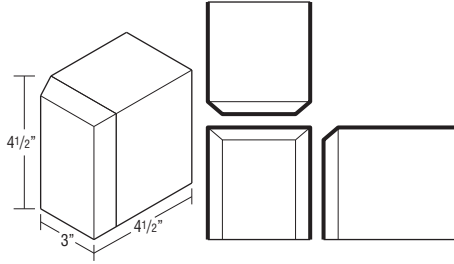

Finish Techniques

Distressing	Heirlooming
	•

Species Availability (Wood)

Alder	Rustic Alder	Cherry	Hickory	Maple	Oak
•	Alder	•	•	•	•

Species Availability (All Laminates)

High Gloss box color	Horiz. Grain on Maple box color	Vert. Grain on Maple box color	Vert. Grain on Cherry box color	Vert. Grain on Hickory box color	Vert. Grain on Oak box color	Thermofoil box color
-------------------------	---------------------------------------	--------------------------------------	---------------------------------------	--	------------------------------------	-------------------------

TAPERED LEG, 6" HIGH



TAPLGL

• Trimmable.

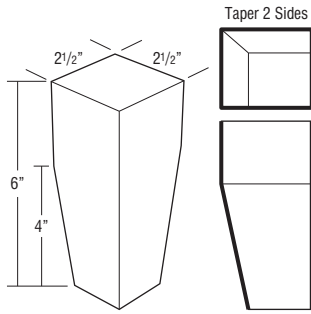

Finish Techniques

Distressing	Heirlooming
	•

Species Availability (Wood)

Alder	Rustic Alder	Cherry	Hickory	Maple	Oak
•	Alder	•		•	

Species Availability (All Laminates)

High Gloss box color	Horiz. Grain on Maple box color	Vert. Grain on Maple box color	Vert. Grain on Cherry box color	Vert. Grain on Hickory	Vert. Grain on Oak box color	Thermofoil box color
-------------------------	---------------------------------------	--------------------------------------	---------------------------------------	---------------------------	------------------------------------	-------------------------

DESCRIPTION

MODEL

TOEKICK TULIP FOOT,  
4 5/8" HIGH



TKTLFOOT

• Trimmable.

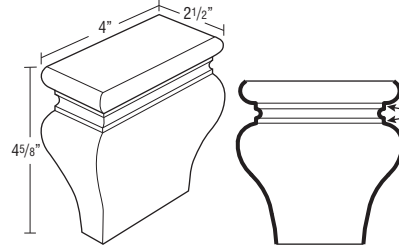

Finish Techniques

Distressing	Heirlooming
	•

Species Availability (Wood)

Alder	Rustic Alder	Cherry	Hickory	Maple	Oak
•	Alder	•		•	•

Species Availability (All Laminates)

High Gloss box color	Horiz. Grain on Maple box color	Vert. Grain on Maple box color	Vert. Grain on Cherry box color	Vert. Grain on Hickory	Vert. Grain on Oak box color	Thermofoil box color
-------------------------	---------------------------------------	--------------------------------------	---------------------------------------	---------------------------	------------------------------------	-------------------------

TULIP FOOT, 4 5/8" HIGH



TLFOOT

• Trimmable.

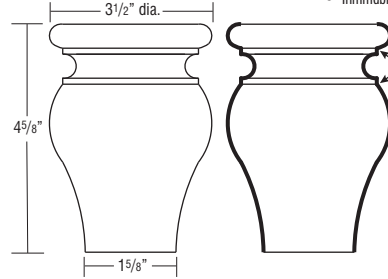

Finish Techniques

Distressing	Heirlooming
	•

Species Availability (Wood)

Alder	Rustic Alder	Cherry	Hickory	Maple	Oak
•	Alder	•		•	•

Species Availability (All Laminates)

High Gloss box color	Horiz. Grain on Maple box color	Vert. Grain on Maple box color	Vert. Grain on Cherry box color	Vert. Grain on Hickory	Vert. Grain on Oak box color	Thermofoil box color
-------------------------	---------------------------------------	--------------------------------------	---------------------------------------	---------------------------	------------------------------------	-------------------------

Finished edges indicated by bold lines on side view drawings.  
Glazed edges indicated by arrows on side view drawings.



**DESCRIPTION**

**MODEL**

**2" DECORATIVE SPLIT TURNINGS**



**SPTRINGEND** (Sold in Pairs)

**JSPTRINGCTR** ♦

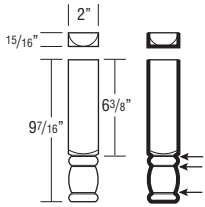

**SPTRINGEND**

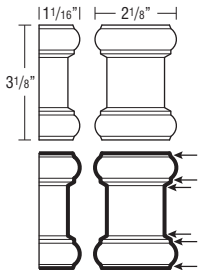

**JSPTRINGCTR**

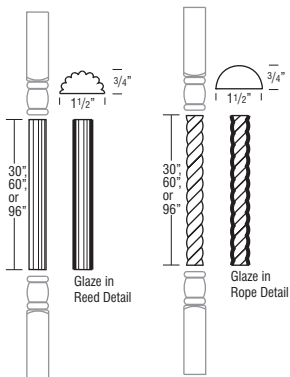

**SPTRINGREED**

**SPTRINGROPE**

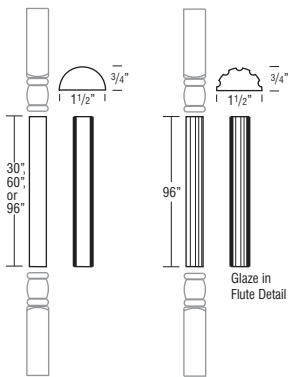

**SPTRINGSPPOOL**

**JSPTRINGFLT96**

**SPTRINGREED30**

(Reeded Half Round)

**SPTRINGREED60**

(Reeded Half Round)

**SPTRINGREED96**

(Reeded Half Round)

**SPTRINGROPE30**

(Rope Right Twist Half Round)

**SPTRINGROPE60**

(Rope Right Twist Half Round)

**SPTRINGROPE96**

(Rope Right Twist Half Round)

**SPTRINGSPPOOL30**

(Half Round)

**SPTRINGSPPOOL60**

(Half Round)

**SPTRINGSPPOOL96**

(Half Round)

**JSPTRINGFLT96** ♦

(Half Round)

- Ends sold separately from split turnings.
- 5 day Express Response not available on Architectural Accents.

**Finish Techniques**

Distressing	Heirlooming
	•

**Species Availability (Wood)**

Alder	Rustic Alder	Cherry	Hickory	Maple	Oak
•	•	•	•	•	•

♦ Not available in Hickory.

**Species Availability (All Laminates)**

High Gloss box color	Horiz. Grain on Maple box color	Vert. Grain on Maple box color	Vert. Grain on Cherry box color	Vert. Grain on Hickory box color	Vert. Grain on Oak box color	Thermofoil box color
----------------------	---------------------------------	--------------------------------	---------------------------------	----------------------------------	------------------------------	----------------------

♦ Not available in Hickory box color.

**DESCRIPTION**

**MODEL**

**3" DECORATIVE SPLIT TURNINGS**



**J3SPTRINGBLK**

**J3SPTRINGFIN**

**J3SPTRINGWV**

**J3SPTRINGCTR**

**J3SPTRINGSP96**

**J3SPTRINGRP96**

**J3SPTRINGRD96**

**J3SPTRINGFL96**

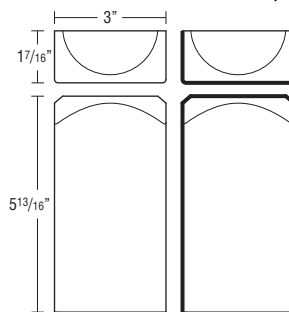

**J3SPTRINGBLK**

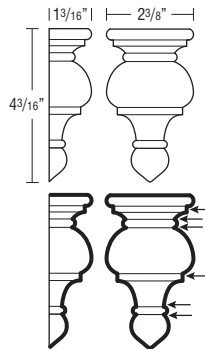

**J3SPTRINGFIN**

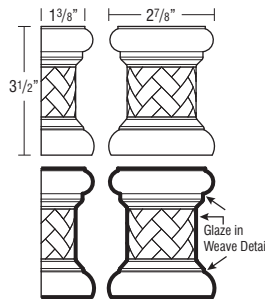

**J3SPTRINGWV**

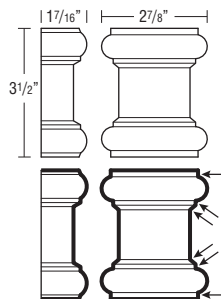

**J3SPTRINGCTR**

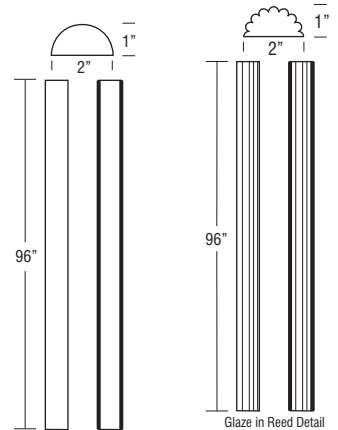

**J3SPTRINGSP96**

**J3SPTRINGRD96**

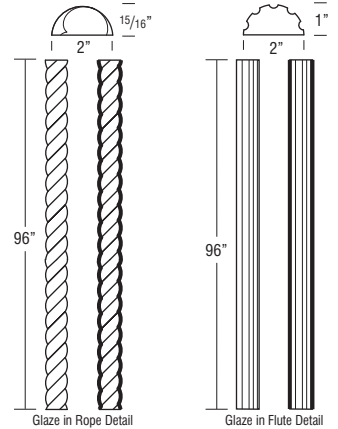

**J3SPTRINGRP96**

**J3SPTRINGFL96**

**Finish Techniques**

Distressing	Heirlooming
	•

**Species Availability (Wood)**

Alder	Rustic Alder	Cherry	Hickory	Maple	Oak
•	•	•	•	•	•

**Species Availability (All Laminates)**

High Gloss box color	Horiz. Grain on Maple box color	Vert. Grain on Maple box color	Vert. Grain on Cherry box color	Vert. Grain on Hickory box color	Vert. Grain on Oak box color	Thermofoil box color
----------------------	---------------------------------	--------------------------------	---------------------------------	----------------------------------	------------------------------	----------------------

Finished edges indicated by bold lines on side view drawings.  
Glazed edges indicated by arrows on side view drawings.

**DESCRIPTION**

**9" SMALL CORBEL**



**MODEL**

**SMCORBEL**

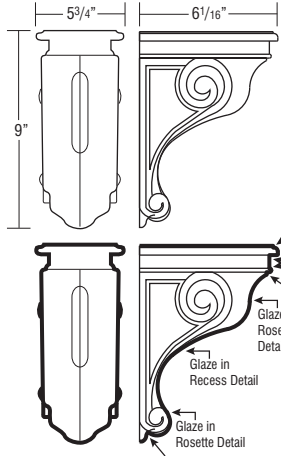

- Not intended for cabinet or freestanding countertop support. For substantial weight support, use a floor mounted support such as a Decorative Leg.

**Finish Techniques**

Distressing	Heirlooming
	•

**Species Availability (Wood)**

Alder	Rustic Alder	Cherry	Hickory	Maple	Oak
•	Alder	•		•	•

**Species Availability (All Laminates)**

High Gloss box color	Horiz. Grain on Maple box color	Vert. Grain on Maple box color	Vert. Grain on Cherry box color	Vert. Grain on Hickory	Vert. Grain on Oak box color	Thermofoil box color
----------------------	---------------------------------	--------------------------------	---------------------------------	------------------------	------------------------------	----------------------

**13" LARGE CORBEL**



**LGCORBEL**

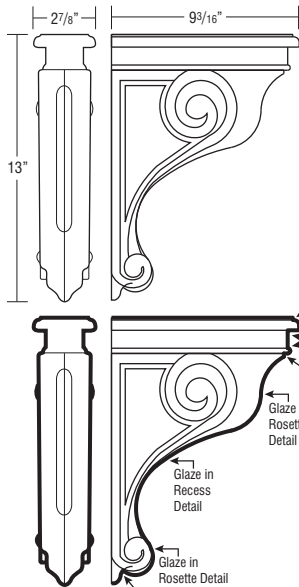

- Not intended for cabinet or freestanding countertop support. For substantial weight support, use a floor mounted support such as a Decorative Leg.

**Finish Techniques**

Distressing	Heirlooming
	•

**Species Availability (Wood)**

Alder	Rustic Alder	Cherry	Hickory	Maple	Oak
•	Alder	•		•	•

**Species Availability (All Laminates)**

High Gloss box color	Horiz. Grain on Maple box color	Vert. Grain on Maple box color	Vert. Grain on Cherry box color	Vert. Grain on Hickory	Vert. Grain on Oak box color	Thermofoil box color
----------------------	---------------------------------	--------------------------------	---------------------------------	------------------------	------------------------------	----------------------

**DESCRIPTION**

**9" ART CORBEL**



**MODEL**

**CORBELART9**

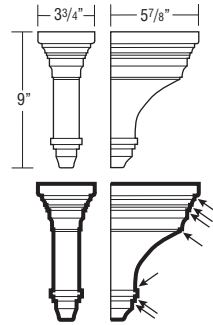

- Not intended for cabinet or freestanding countertop support. For substantial weight support, use a floor mounted support such as a Decorative Leg.

**Finish Techniques**

Distressing	Heirlooming
	•

**Species Availability (Wood)**

Alder	Rustic Alder	Cherry	Hickory	Maple	Oak
•	Alder	•		•	•

**Species Availability (All Laminates)**

High Gloss box color	Horiz. Grain on Maple box color	Vert. Grain on Maple box color	Vert. Grain on Cherry box color	Vert. Grain on Hickory	Vert. Grain on Oak box color	Thermofoil box color
----------------------	---------------------------------	--------------------------------	---------------------------------	------------------------	------------------------------	----------------------

**7" CELTIC CORBEL**



**CORBELCELT**

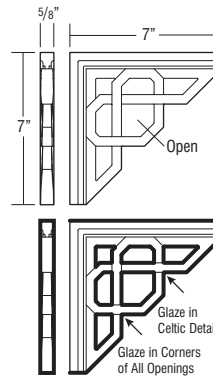

- Not intended for cabinet or freestanding countertop support. For substantial weight support, use a floor mounted support such as a Decorative Leg.

**Finish Techniques**

Distressing	Heirlooming
	•

**Species Availability (Wood)**

Alder	Rustic Alder	Cherry	Hickory	Maple	Oak
		•		•	•

**Species Availability (All Laminates)**

High Gloss box color	Horiz. Grain on Maple box color	Vert. Grain on Maple box color	Vert. Grain on Cherry box color	Vert. Grain on Hickory	Vert. Grain on Oak box color	Thermofoil box color
----------------------	---------------------------------	--------------------------------	---------------------------------	------------------------	------------------------------	----------------------

**7" SMALL COSMO CORBEL**



**JCORBELCOS7**

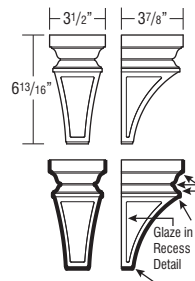

- Not intended for cabinet or freestanding countertop support. For substantial weight support, use a floor mounted support such as a Decorative Leg.

**Finish Techniques**

Distressing	Heirlooming
	•

**Species Availability (Wood)**

Alder	Rustic Alder	Cherry	Hickory	Maple	Oak
•	Alder	•		•	•

**Species Availability (All Laminates)**

High Gloss box color	Horiz. Grain on Maple box color	Vert. Grain on Maple box color	Vert. Grain on Cherry box color	Vert. Grain on Hickory	Vert. Grain on Oak box color	Thermofoil box color
----------------------	---------------------------------	--------------------------------	---------------------------------	------------------------	------------------------------	----------------------

Finished edges indicated by bold lines on side view drawings.  
Glazed edges indicated by arrows on side view drawings.

**DESCRIPTION**

**MODEL**

**13" LARGE COSMO CORBEL**



**JCORBELCOS13**

- Not intended for cabinet or freestanding countertop support. For substantial weight support, use a floor mounted support such as a Decorative Leg.

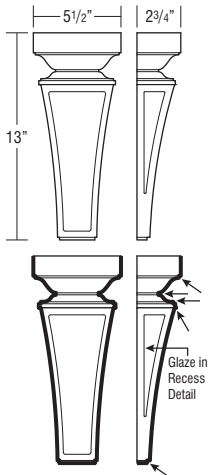

**Finish Techniques**

Distressing	Heirlooming
	•

**Species Availability (Wood)**

Alder	Rustic Alder	Cherry	Hickory	Maple	Oak
•	Alder	•		•	•

**Species Availability (All Laminates)**

High Gloss box color	Horiz. Grain on Maple box color	Vert. Grain on Maple box color	Vert. Grain on Cherry box color	Vert. Grain on Hickory box color	Vert. Grain on Oak box color	Thermofoil box color
----------------------	---------------------------------	--------------------------------	---------------------------------	----------------------------------	------------------------------	----------------------

**13" LARGE COSMO CORBEL DEEP**



**JCORBELCOS13D**

- Not intended for cabinet or freestanding countertop support. For substantial weight support, use a floor mounted support such as a Decorative Leg.

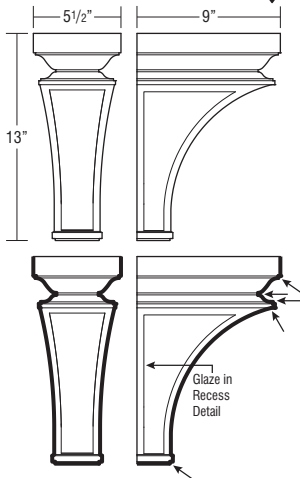

**Finish Techniques**

Distressing	Heirlooming
	•

**Species Availability (Wood)**

Alder	Rustic Alder	Cherry	Hickory	Maple	Oak
•	Alder	•		•	•

**Species Availability (All Laminates)**

High Gloss box color	Horiz. Grain on Maple box color	Vert. Grain on Maple box color	Vert. Grain on Cherry box color	Vert. Grain on Hickory box color	Vert. Grain on Oak box color	Thermofoil box color
----------------------	---------------------------------	--------------------------------	---------------------------------	----------------------------------	------------------------------	----------------------

**7" COVE CORBEL**



**CORBELCOVE7**

- Not intended for cabinet or freestanding countertop support. For substantial weight support, use a floor mounted support such as a Decorative Leg.

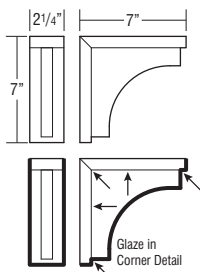

**Finish Techniques**

Distressing	Heirlooming
	•

**Species Availability (Wood)**

Alder	Rustic Alder	Cherry	Hickory	Maple	Oak
•	Alder	•	•	•	•

**Species Availability (All Laminates)**

High Gloss box color	Horiz. Grain on Maple box color	Vert. Grain on Maple box color	Vert. Grain on Cherry box color	Vert. Grain on Hickory box color	Vert. Grain on Oak box color	Thermofoil box color
----------------------	---------------------------------	--------------------------------	---------------------------------	----------------------------------	------------------------------	----------------------

**DESCRIPTION**

**MODEL**

**11 1/4" COVE CORBEL**



**CORBELCOVE11**

- Not intended for cabinet or freestanding countertop support. For substantial weight support, use a floor mounted support such as a Decorative Leg.

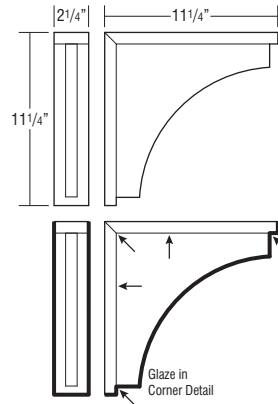

**Finish Techniques**

Distressing	Heirlooming
	•

**Species Availability (Wood)**

Alder	Rustic Alder	Cherry	Hickory	Maple	Oak
•	Alder	•	•	•	•

**Species Availability (All Laminates)**

High Gloss box color	Horiz. Grain on Maple box color	Vert. Grain on Maple box color	Vert. Grain on Cherry box color	Vert. Grain on Hickory box color	Vert. Grain on Oak box color	Thermofoil box color
----------------------	---------------------------------	--------------------------------	---------------------------------	----------------------------------	------------------------------	----------------------

**6" MISSION CORBEL**



**CORBELMIS6**

- Not intended for cabinet or freestanding countertop support. For substantial weight support, use a floor mounted support such as a Decorative Leg.

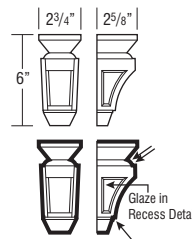

**Finish Techniques**

Distressing	Heirlooming
	•

**Species Availability (Wood)**

Alder	Rustic Alder	Cherry	Hickory	Maple	Oak
•	Alder	•		•	•

**Species Availability (All Laminates)**

High Gloss box color	Horiz. Grain on Maple box color	Vert. Grain on Maple box color	Vert. Grain on Cherry box color	Vert. Grain on Hickory box color	Vert. Grain on Oak box color	Thermofoil box color
----------------------	---------------------------------	--------------------------------	---------------------------------	----------------------------------	------------------------------	----------------------

**9" MISSION CORBEL**



**CORBELMIS9**

- Not intended for cabinet or freestanding countertop support. For substantial weight support, use a floor mounted support such as a Decorative Leg.

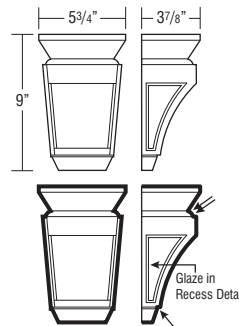

**Finish Techniques**

Distressing	Heirlooming
	•

**Species Availability (Wood)**

Alder	Rustic Alder	Cherry	Hickory	Maple	Oak
•	Alder	•		•	•

**Species Availability (All Laminates)**

High Gloss box color	Horiz. Grain on Maple box color	Vert. Grain on Maple box color	Vert. Grain on Cherry box color	Vert. Grain on Hickory box color	Vert. Grain on Oak box color	Thermofoil box color
----------------------	---------------------------------	--------------------------------	---------------------------------	----------------------------------	------------------------------	----------------------

Finished edges indicated by bold lines on side view drawings.  
Glazed edges indicated by arrows on side view drawings.

**DESCRIPTION**

**MODEL**

**4" OLD WORLD CORBEL**



**JCORBELOWD4**

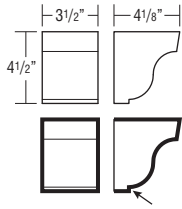

- Not intended for cabinet or freestanding countertop support. For substantial weight support, use a floor mounted support such as a Decorative Leg.

**Finish Techniques**

Distressing	Heirlooming
	•

**Species Availability (Wood)**

Alder	Rustic Alder	Cherry	Hickory	Maple	Oak
•	•	•		•	•

**Species Availability (All Laminates)**

High Gloss box color	Horiz. Grain on Maple box color	Vert. Grain on Maple box color	Vert. Grain on Cherry box color	Vert. Grain on Hickory	Vert. Grain on Oak box color	Thermofoil box color
----------------------	---------------------------------	--------------------------------	---------------------------------	------------------------	------------------------------	----------------------

**5" OLD WORLD CORBEL**



**CORBELOWD5**

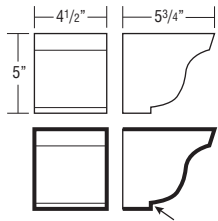

- Not intended for cabinet or freestanding countertop support. For substantial weight support, use a floor mounted support such as a Decorative Leg.

**Finish Techniques**

Distressing	Heirlooming
	•

**Species Availability (Wood)**

Alder	Rustic Alder	Cherry	Hickory	Maple	Oak
•	•	•		•	•

**Species Availability (All Laminates)**

High Gloss box color	Horiz. Grain on Maple box color	Vert. Grain on Maple box color	Vert. Grain on Cherry box color	Vert. Grain on Hickory	Vert. Grain on Oak box color	Thermofoil box color
----------------------	---------------------------------	--------------------------------	---------------------------------	------------------------	------------------------------	----------------------

**7" OLD WORLD CORBEL**



**JCORBELOWD7**

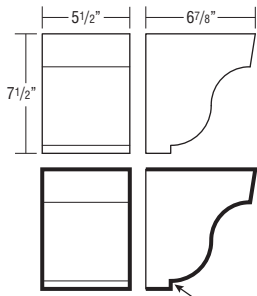

- Not intended for cabinet or freestanding countertop support. For substantial weight support, use a floor mounted support such as a Decorative Leg.

**Finish Techniques**

Distressing	Heirlooming
	•

**Species Availability (Wood)**

Alder	Rustic Alder	Cherry	Hickory	Maple	Oak
•	•	•		•	•

**Species Availability (All Laminates)**

High Gloss box color	Horiz. Grain on Maple box color	Vert. Grain on Maple box color	Vert. Grain on Cherry box color	Vert. Grain on Hickory	Vert. Grain on Oak box color	Thermofoil box color
----------------------	---------------------------------	--------------------------------	---------------------------------	------------------------	------------------------------	----------------------

**6" SCROLL CORBEL**



**CORBELSCR6**

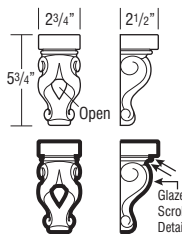

- Not intended for cabinet or freestanding countertop support. For substantial weight support, use a floor mounted support such as a Decorative Leg.

**Finish Techniques**

Distressing	Heirlooming
	•

**Species Availability (Wood)**

Alder	Rustic Alder	Cherry	Hickory	Maple	Oak
•	•	•		•	•

**Species Availability (All Laminates)**

High Gloss box color	Horiz. Grain on Maple box color	Vert. Grain on Maple box color	Vert. Grain on Cherry box color	Vert. Grain on Hickory	Vert. Grain on Oak box color	Thermofoil box color
----------------------	---------------------------------	--------------------------------	---------------------------------	------------------------	------------------------------	----------------------

**DESCRIPTION**

**MODEL**

**9" SCROLL CORBEL**



**CORBELSCR9**

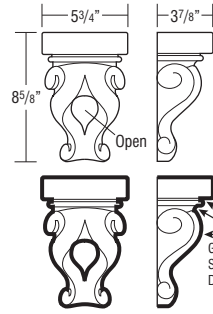

- Not intended for cabinet or freestanding countertop support. For substantial weight support, use a floor mounted support such as a Decorative Leg.

**Finish Techniques**

Distressing	Heirlooming
	•

**Species Availability (Wood)**

Alder	Rustic Alder	Cherry	Hickory	Maple	Oak
•	•	•		•	•

**Species Availability (All Laminates)**

High Gloss box color	Horiz. Grain on Maple box color	Vert. Grain on Maple box color	Vert. Grain on Cherry box color	Vert. Grain on Hickory	Vert. Grain on Oak box color	Thermofoil box color
----------------------	---------------------------------	--------------------------------	---------------------------------	------------------------	------------------------------	----------------------

**SNACK BAR SUPPORT**



**SBS**

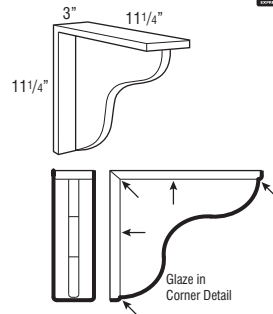

- Not intended for cabinet or freestanding countertop support. For substantial weight support, use a floor mounted support such as a Decorative Leg.

**Finish Techniques**

Distressing	Heirlooming
	•

**Species Availability (Wood)**

Alder	Rustic Alder	Cherry	Hickory	Maple	Oak
•	•	•		•	•

**Species Availability (All Laminates)**

High Gloss box color	Horiz. Grain on Maple box color	Vert. Grain on Maple box color	Vert. Grain on Cherry box color	Vert. Grain on Hickory	Vert. Grain on Oak box color	Thermofoil box color
----------------------	---------------------------------	--------------------------------	---------------------------------	------------------------	------------------------------	----------------------

**10" ACANTHUS CORBEL**



**JCORBELACAN10**

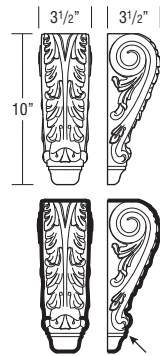

- Not intended for cabinet or freestanding countertop support. For substantial weight support, use a floor mounted support such as a Decorative Leg.

**Finish Techniques**

Distressing	Heirlooming
	•

**Species Availability (Wood)**

Alder	Rustic Alder	Cherry	Hickory	Maple	Oak
•	•	•		•	•

**Species Availability (All Laminates)**

High Gloss box color	Horiz. Grain on Maple box color	Vert. Grain on Maple box color	Vert. Grain on Cherry box color	Vert. Grain on Hickory	Vert. Grain on Oak box color	Thermofoil box color
----------------------	---------------------------------	--------------------------------	---------------------------------	------------------------	------------------------------	----------------------

Finished edges indicated by bold lines on side view drawings.  
Glazed edges indicated by arrows on side view drawings.

**DESCRIPTION**

**11 1/2" ARTS & CRAFTS BRACKET**

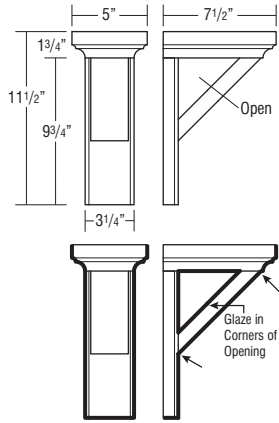

**MODEL**

**JBRACKETART**

- Not intended for cabinet or freestanding countertop support. For substantial weight support, use a floor mounted support such as a Decorative Leg.

**Finish Techniques**

Distressing	Heirloom
	•

**Species Availability (Wood)**

Alder	Rustic Alder	Cherry	Hickory	Maple	Oak
•	Alder	•		•	•

**Species Availability (All Laminates)**

High Gloss box color	Horiz. Grain on Maple box color	Vert. Grain on Maple box color	Vert. Grain on Cherry box color	Vert. Grain on Hickory	Vert. Grain on Oak box color	Thermofoil box color
----------------------	---------------------------------	--------------------------------	---------------------------------	------------------------	------------------------------	----------------------

**14" ARTS & CRAFTS OPEN CORBEL**

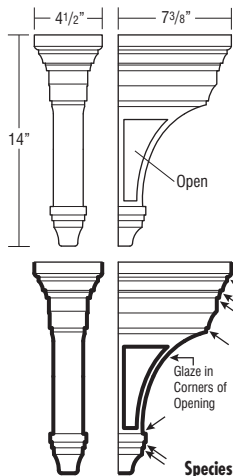

**JCORBELARTO**

- Not intended for cabinet or freestanding countertop support. For substantial weight support, use a floor mounted support such as a Decorative Leg.

**Finish Techniques**

Distressing	Heirloom
	•

**Species Availability (Wood)**

Alder	Rustic Alder	Cherry	Hickory	Maple	Oak
•	Alder	•		•	•

**Species Availability (All Laminates)**

High Gloss box color	Horiz. Grain on Maple box color	Vert. Grain on Maple box color	Vert. Grain on Cherry box color	Vert. Grain on Hickory	Vert. Grain on Oak box color	Thermofoil box color
----------------------	---------------------------------	--------------------------------	---------------------------------	------------------------	------------------------------	----------------------

**DESCRIPTION**

**12" CRAFTSMAN OPEN BRACKET**

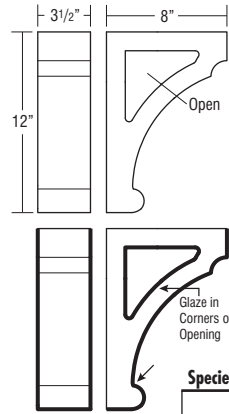

**MODEL**

**JCORBELCRAFTO**

- Not intended for cabinet or freestanding countertop support. For substantial weight support, use a floor mounted support such as a Decorative Leg.

**Finish Techniques**

Distressing	Heirloom
	•

**Species Availability (Wood)**

Alder	Rustic Alder	Cherry	Hickory	Maple	Oak
•	Alder	•		•	•

**Species Availability (All Laminates)**

High Gloss box color	Horiz. Grain on Maple box color	Vert. Grain on Maple box color	Vert. Grain on Cherry box color	Vert. Grain on Hickory	Vert. Grain on Oak box color	Thermofoil box color
----------------------	---------------------------------	--------------------------------	---------------------------------	------------------------	------------------------------	----------------------

**3" MINI SHAKER CORBEL**

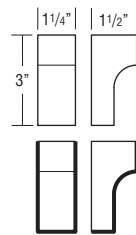

**JCORBELSHKR3**

- Not intended for cabinet or freestanding countertop support. For substantial weight support, use a floor mounted support such as a Decorative Leg.

**Finish Techniques**

Distressing	Heirloom
	•

**Species Availability (Wood)**

Alder	Rustic Alder	Cherry	Hickory	Maple	Oak
•	Alder	•		•	•

**Species Availability (All Laminates)**

High Gloss box color	Horiz. Grain on Maple box color	Vert. Grain on Maple box color	Vert. Grain on Cherry box color	Vert. Grain on Hickory	Vert. Grain on Oak box color	Thermofoil box color
----------------------	---------------------------------	--------------------------------	---------------------------------	------------------------	------------------------------	----------------------

**6 1/2" SMALL SHAKER CORBEL**

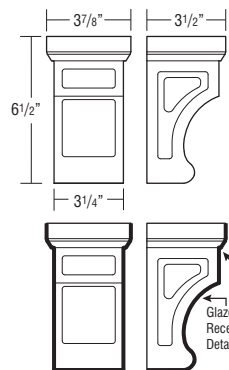

**JCORBELSHKR7**

- Not intended for cabinet or freestanding countertop support. For substantial weight support, use a floor mounted support such as a Decorative Leg.

**Finish Techniques**

Distressing	Heirloom
	•

**Species Availability (Wood)**

Alder	Rustic Alder	Cherry	Hickory	Maple	Oak
•	Alder	•		•	•

**Species Availability (All Laminates)**

High Gloss box color	Horiz. Grain on Maple box color	Vert. Grain on Maple box color	Vert. Grain on Cherry box color	Vert. Grain on Hickory	Vert. Grain on Oak box color	Thermofoil box color
----------------------	---------------------------------	--------------------------------	---------------------------------	------------------------	------------------------------	----------------------

Finished edges indicated by bold lines on side view drawings.  
Glazed edges indicated by arrows on side view drawings.

**DESCRIPTION**

**13 3/8" MEDIUM SHAKER CORBEL**

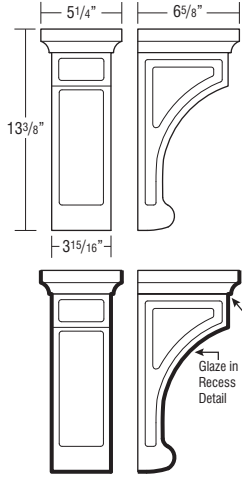

**MODEL**

**JCORBELSHKR14**

- Not intended for cabinet or freestanding countertop support. For substantial weight support, use a floor mounted support such as a Decorative Leg.

**Finish Techniques**

Distressing	Heirlooming
	•

**Species Availability (Wood)**

Alder	Rustic Alder	Cherry	Hickory	Maple	Oak
•	Alder	•		•	•

**Species Availability (All Laminates)**

High Gloss box color	Horiz. Grain on Maple box color	Vert. Grain on Maple box color	Vert. Grain on Cherry box color	Vert. Grain on Hickory	Vert. Grain on Oak box color	Thermofoil box color
----------------------	---------------------------------	--------------------------------	---------------------------------	------------------------	------------------------------	----------------------

**16" LARGE SHAKER CORBEL**

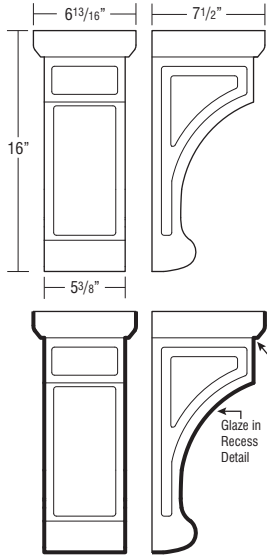

**JCORBELSHKR16**

- Not intended for cabinet or freestanding countertop support. For substantial weight support, use a floor mounted support such as a Decorative Leg.

**Finish Techniques**

Distressing	Heirlooming
	•

**Species Availability (Wood)**

Alder	Rustic Alder	Cherry	Hickory	Maple	Oak
•	Alder	•		•	•

**Species Availability (All Laminates)**

High Gloss box color	Horiz. Grain on Maple box color	Vert. Grain on Maple box color	Vert. Grain on Cherry box color	Vert. Grain on Hickory	Vert. Grain on Oak box color	Thermofoil box color
----------------------	---------------------------------	--------------------------------	---------------------------------	------------------------	------------------------------	----------------------

**DESCRIPTION**

**14" TRADITIONAL OPEN CORBEL**

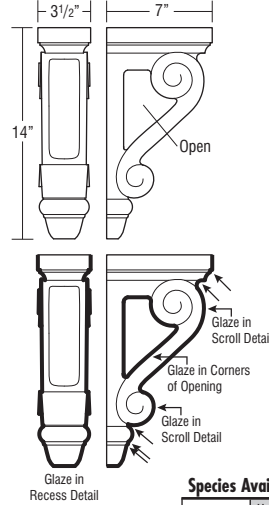

**MODEL**

**JCORBELTRADO**

- Not intended for cabinet or freestanding countertop support. For substantial weight support, use a floor mounted support such as a Decorative Leg.

**Finish Techniques**

Distressing	Heirlooming
	•

**Species Availability (Wood)**

Alder	Rustic Alder	Cherry	Hickory	Maple	Oak
•	Alder	•		•	•

**Species Availability (All Laminates)**

High Gloss box color	Horiz. Grain on Maple box color	Vert. Grain on Maple box color	Vert. Grain on Cherry box color	Vert. Grain on Hickory	Vert. Grain on Oak box color	Thermofoil box color
----------------------	---------------------------------	--------------------------------	---------------------------------	------------------------	------------------------------	----------------------

**SINGLE OUTLET COVER**

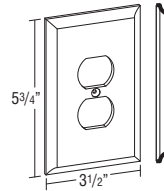

**JSOC**

**Finish Techniques**

Distressing	Heirlooming

**Species Availability (Wood)**

Alder	Rustic Alder	Cherry	Hickory	Maple	Oak
•	Alder	•		•	•

**Species Availability (All Laminates)**

High Gloss box color	Horiz. Grain on Maple box color	Vert. Grain on Maple box color	Vert. Grain on Cherry box color	Vert. Grain on Hickory	Vert. Grain on Oak box color	Thermofoil box color
----------------------	---------------------------------	--------------------------------	---------------------------------	------------------------	------------------------------	----------------------

**SINGLE ROCKER PLATE**

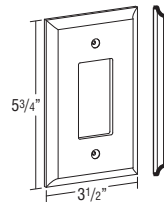

**JSRC**

**Finish Techniques**

Distressing	Heirlooming

**Species Availability (Wood)**

Alder	Rustic Alder	Cherry	Hickory	Maple	Oak
•	Alder	•		•	•

**Species Availability (All Laminates)**

High Gloss box color	Horiz. Grain on Maple box color	Vert. Grain on Maple box color	Vert. Grain on Cherry box color	Vert. Grain on Hickory	Vert. Grain on Oak box color	Thermofoil box color
----------------------	---------------------------------	--------------------------------	---------------------------------	------------------------	------------------------------	----------------------

Finished edges indicated by bold lines on side view drawings.  
Glazed edges indicated by arrows on side view drawings.

**DESCRIPTION**

**MODEL**

**CONTEMPORARY EMBELLISHMENTS**

**METAL FEET, ANGLED**

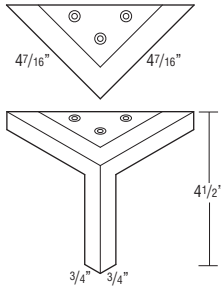

**FOOTMETALANBN**

**FOOTMETALANGPC**

- BN = Brushed Nickel
- PC = Polished Chrome
- Maximum weight capacity is 160 lbs.

**METAL FEET, ROUND**

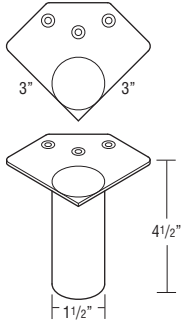

**FOOTMETALRDBS**

**FOOTMETALRDPS**

- BS = Brushed Stainless
- PS = Polished Stainless
- Maximum weight capacity is 150 lbs.

**METAL FEET, SQUARE**

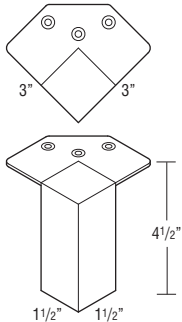

**FOOTMETALSQBS**

**FOOTMETALSQPS**

- BS = Brushed Stainless
- PS = Polished Stainless

**METAL FEET, TEE**

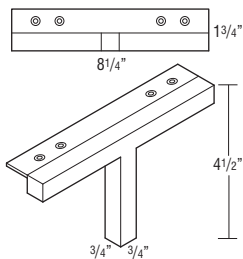

**FOOTMETALANBN**

**FOOTMETALANGPC**

- BN = Brushed Nickel
- PC = Polished Chrome

**TOUCH LATCH**

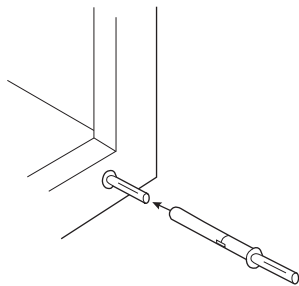

**TOUHLATCH**

- Nylon gray mechanism with bumper tip.
- Face frame will need to be field drilled for insertion of the TOUCHLATCH, requires 25/64" (10mm) drill bit.
- Can be field adjusted for door gap depth, no tools required.
- For use on full overlay door styles only.
- Requires a soft touch to open the door, and door must be pushed closed to reset the TOUCHLATCH mechanism.
- Only for use on hinged doors, and can be used without decorative hardware. Not compatible with non-hinged doors such as pull-outs, Wall Vertical-Lift (WVL.). For drawers, pull-outs, and other non-compatible cabinets, PULLH70 and PULLH71 are recommended (see below).

**DESCRIPTION**

**MODEL**

**FINGER PULL, BRUSHED NICKEL**

**PULLH70**

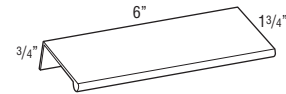

**PULLH71**

**PULLH70**

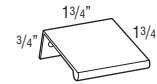

**PULLH71**

**TRUSS METAL CORBEL, STAINLESS STEEL**

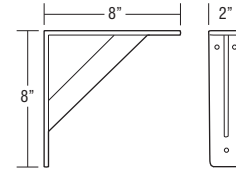

**CORBELTRSS**

- Pre-drilled mounting holes for easy installation.
- 1/4" material thickness.
- Not intended for cabinet or freestanding countertop support. For substantial weight support, use a floor mounted support such as a Decorative Leg.
- Must be properly installed into a structural member of the wall.

**CRESCENT METAL CORBEL, BRUSHED NICKEL**

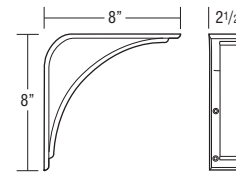

**CORBELCRBN**

- Matching screw caps included to hide the installation screws.
- Pre-drilled mounting holes for easy installation.
- 1/4" material thickness.
- Not intended for cabinet or freestanding countertop support. For substantial weight support, use a floor mounted support such as a Decorative Leg.
- Must be properly installed into a structural member of the wall.

**SHELF SUPPORT BRACKET, SATIN NICKEL**

**SHELFBRKTSN**

- Sold in pairs.
- Can be used with glass shelves 0.28"-0.75" (7-19mm) thick, or wood shelves 0.5"-1.61" (12-41mm) thick.
- Must be properly installed into a structural member of the wall.
- Maximum shelf load varies with shelf depth. For a 12" deep shelf, maximum shelf load is 50 lbs. each including shelf weight.

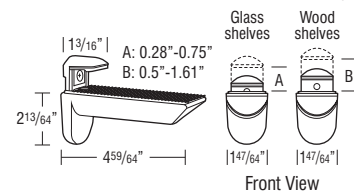



**DESCRIPTION**

**MODEL**

**LIGHTING**

- LEDs are a solid state lighting source. LEDs are more efficient, durable, and safer than older light sources.
- CW = Cool White (Kelvin rating: 5000)
- WW = Warm White (Kelvin rating: 3200)

**LED PUCK LIGHTING, STANDARD**



**PUCK18CW**  
**PUCK18WW**

- Contains 18 LED diodes with a life span of 50,000 hours.
- Measures less than 1/4" for low profile surface mounting.
- 65° beam angle.
- Compatible with Dimmable Driver (DIMM241512) and Power Extension Cable (CABL2500).
- Available in: warm or cool white in plastic housing with an aluminum color finish.
- Puck dimension is 2.56" x 2.56" (65mm x 65mm).
- Power usage: 1.25 watts.
- Voltage: 24V Compatibility.

**LED PUCK LIGHTING, HIGH DEFINITION**

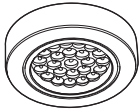

surface mount

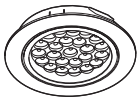

flush mount



**PUCK24CW**  
**PUCK24WW**

- Contains 24 LED diodes with a life span of 50,000 hours.
- Surface or flush mounted (remove ring for flush mounting).
- 50° beam angle.
- Compatible with Dimmable Driver (DIMM241512) and Power Extension Cable (CABL2500).
- Available in: warm or cool white light in aluminum housing.
- Puck diameter is 2.58" (65.5mm) and height is 0.41" (10.5mm).
- Power usage: 1.65 watts.
- Voltage: 24V Compatibility.

**LED FLEXIBLE STRIP**

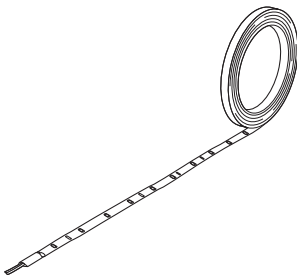

**FLEX12CW**  
**FLEX12WW**  
**FLEX36CW**  
**FLEX36WW**

- Linkable and trimmable in increments of either 3" (FLEX12..) or 3 1/4" (FLEX36..), not to exceed a total of 18'.
- Adhesive back.
- Compatible with Dimmable Driver (DIMM121512) and Flex Driver Connection Lead (LEADDFLX2500).
- Suggested use: installed over cabinet, under cabinet, in cabinet, and on the toekick.
- Available in: warm or cool white.
- FLEX12.. Dimensions: Length 11.81" (300mm), Width 0.31" (8mm), and Depth 0.1" (2.5mm).
- FLEX36.. Dimensions: Length: 39.37" (1000mm), Width 0.31" (8mm), and Depth 0.1" (2.5mm).
- Power usage: 0.8 watts (FLEX12..) and 2.5 watts (FLEX36..).
- Voltage: 12V Compatibility.

**DESCRIPTION**

**MODEL**

**LED RIGID STRIP**



**RIGID12CW**  
**RIGID12WW**  
**RIGID24CW**  
**RIGID24WW**

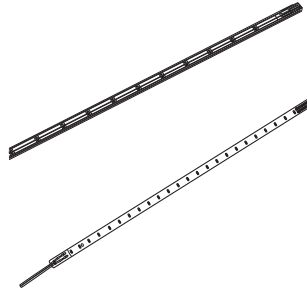

- Linkable.
- Suggested use: straight runs (use link wires for corners).
- Available in 12 or 24 diodes per stick.
- Easy-to-clean, protective shell.
- Compatible with Dimmable Driver (DIMM121512) and Rigid Driver Connection Cable (CABLRIG2500).
- Available in: warm or cool white.
- Includes brackets and screws for easy installation.
- 50,000 hour life span.
- Dimensions (12 Diodes): Length 11.81" (300mm), Width 0.31" (8mm), and Depth 0.24" (6mm).
- Dimensions (24 Diodes): Length 11.22" (285mm), Width 0.31" (8mm), and Depth 0.24" (6mm).
- Power usage: 0.8 watts (RIGID12..) and 1.5 watts (RIGID24..).
- Voltage: 12V Compatibility.

**BATTERY STRIP LIGHT**



**BATTLTI**

- Battery operated – (4) AAA batteries (not included).
- Motion activated.
- Low power usage (0.3W).
- Plastic aluminum finish.
- Dimensions: Length 11.93" (303mm), Width 0.67" (17mm), and Depth 0.55" (14mm).
- Easy adhesive install.

**STANDARD DRIVERS**

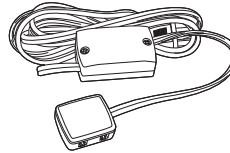

**STAND1264**  
**STAND2464**

**STAND1264**  
**STAND2464**  
**STAND121512**  
**STAND123012**  
**STAND243012**  
**STAND242012**

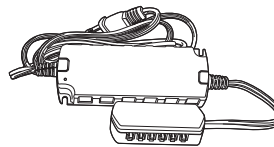

**STAND121512**

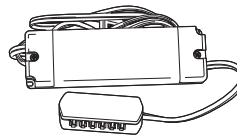

**STAND123012**  
**STAND243012**

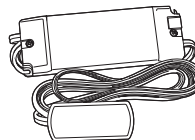

**STAND242012**

- Product Codes list the driver voltage, watts, and connector ports, such as STAND123012 is 12V, 30W, and 12 connector ports.

	Voltage	Wattage (Max Load)	Connector Ports
STAND1264	12	6	4
STAND2464	24	6	4
STAND121512	12	15	12
STAND123012	12	30	12
STAND243012	24	30	12
STAND242012	24	20	12



**DESCRIPTION**

**MODEL**

**AC DIMMABLE DRIVERS (DAYBREAK)**



**DIMM121512**  
**DIMM241512**

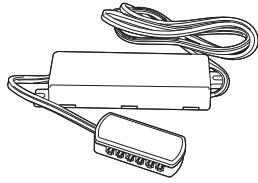

- Compatible with most standard wall dimmers.
- Drivers can be hard wired or used with included plug head. Multiple drivers can be used with a single wall dimmer switch and voltages can be mixed.

	Voltage	Wattage (Max Load)	Connector Ports
DIMM121512	12	15	12
DIMM241512	24	15	12

**INFRARED LIGHT SWITCH**



**IR1224**

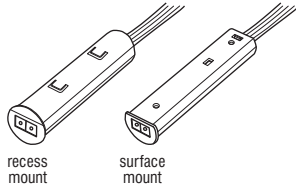

recess mount

surface mount

- Compatible with both 12V and 24V products.
- Can be installed inside or under a cabinet or recessed into moulding, turns on and off by passing hand in front of it or when cabinet door is opened or closed.

**LIGHTING ACCESSORIES**

- LEDs are a solid state lighting source. LEDs are more efficient, durable, and safer than older light sources.

**POWER EXTENSION CABLE**



**CABL2500**

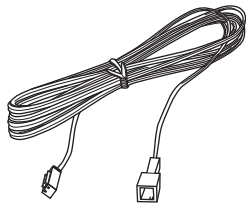

- Provides an additional 98.43" to reach those fixtures which are out of reach with the standard power leads.
- Features a male connector on one end and a female connector on the other.
- Compatible with PUCK18\_\_ and PUCK24\_\_.

**FLEX DRIVER CONNECTION LEAD**



**LEADFLX2500**

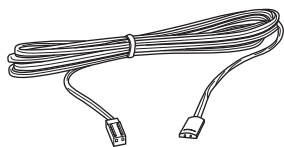

- Required part for each LED flexible strip series, connects the first LED flexible strip in the series to the driver.
- Lead length is 98".
- Compatible with FLEX12\_\_ and FLEX36\_\_.

**FLEX INTER CONNECTIONS**



**CONNFLXCRN50**

**LEADFLXC500**

**LEADFLXC1500**

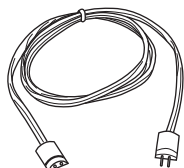
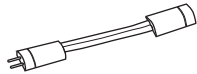

**LEADFLXC500**  
**LEADFLXC1500**

- Used with the LED flexible strips to connect strips together while allowing a gap between sections.
- CONNFLXCRN50 is 1.97" (50mm) and is recommended for the connection of two flexible strips around a corner.
- LEADFLXC500 is 19.69" (500mm), suggested use is around small obstructions.
- LEADFLXC1500 is 59" (1500mm), suggested use is around large appliances such as microwaves and refrigerators.
- Compatible with FLEX12\_\_ and FLEX36\_\_.

**DESCRIPTION**

**MODEL**

**RIGID DRIVER CONNECTION CABLE**



**CABLRIGD2500**

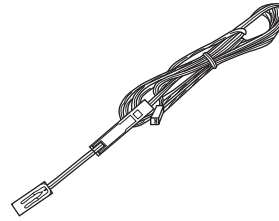

- Required to connect the first LED strip in a series to the driver.
- Cable length is 98".
- Compatible with RIGID12\_\_ and RIGID24\_\_.

**RIGID INTER CONNECTIONS**



**CABLRIGCRN30**

**CABLRIGIC300**

**LEADRIC1500**

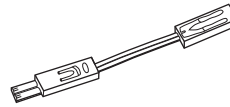

**CABLRIGCRN30**

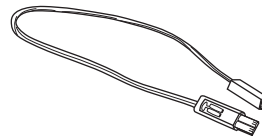

**CABLRIGIC300**

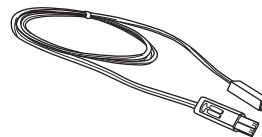

**LEADRIC1500**

- Used with the LED rigid strips to connect strips together while allowing a gap between sections.
- CABLRIGCRN30 is 1.18" (30mm) and is recommended for the connection of two rigid strips around a corner.
- CABLRIGIC300 is 11.81" (300mm).
- LEADRIC1500 is 59" (1500mm), suggested use is around large appliances such as microwaves and refrigerators.
- Compatible with RIGID12\_\_ and RIGID24\_\_.

**RIGID STRIP END CAP**



**ENDRIG**



- Used to provide a clean and professional termination of the rigid strip light series.
- Compatible with RIGID12\_\_ and RIGID24\_\_.

**QUATTRO DIMMING RECEIVER**



**QDIMREC**



- Wireless RF control for an easy, no wire installation.
- Unlimited receiver locations per zone.
- Up to 100' of wireless operation even through obstacles like walls.
- 256 levels of extra smooth dimming.
- Soft start On/Off for gradual dimming.

**QUATTRO WALL CONTROLLER**





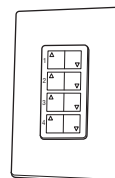

















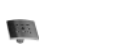





**Q4ZONECON**















- Wireless RF control for an easy, no wire installation.
- Unlimited receiver locations per zone with Quattro Dimming Receiver.
- Up to 100' of wireless operation.
- Detachable face for easy handheld remote operation and battery changing.
- Up to 100' of wireless operation even through obstacles like walls.
- Multiple switches per zone for easy 2, 3, or 4 way control.
- Can be ganged (grouped) with wall switches or outlets behind a single cover plate.
- Includes low cost, long life lithium 3V battery for up to 10 years of operation.

**DESCRIPTION MODEL**  
**DECORATIVE HARDWARE**

**HARDWARE - DECORATIVE PULLS AND KNOBS**

	<b>KNOBH06 - Copper Antique Highlight</b> (1 1/4"W x 1 1/8"L)
	<b>KNOBH07 - Copper Antique Highlight</b> (2 1/4"W x 1 1/16"L)
	<b>PULLH08 - Copper Antique Highlight - 128mm C/C</b> (15/16"W x 5 1/2"L x 1 1/16"H)
	<b>KNOBH10 - Nickel Antique Highlight</b> (1 5/16"W x 3/4"H)
	<b>PULLH11 - Nickel Antique Highlight - 96mm C/C</b> (3/8"W x 4 3/4"L x 1 3/8"H)
	<b>KNOBH20 - Red Rust Antique</b> (1 1/4"W x 1"H)
	<b>KNOBH23 - Ultra Brush Nickel</b> (1 1/4"W x 1"H)
	<b>PULLH30 - Ultra Brush Nickel - 128mm C/C</b> (3/16"W x 6 1/2"L x 1 1/8"H)
	<b>KNOBH31 - Ultra Brush Nickel</b> (1"W x 3/4"H)
	<b>KNOBH32 - Ultra Brush Nickel</b> (1"W x 1/2"H)
	<b>PULLH34 - Rust Pewter</b> (1/4"W x 1.28"L)
	<b>KNOBH35 - Rust Pewter</b> (1.27"W x 1.03"L)
	<b>PULLH36 - Red Rust Antique - 6" C/C</b> (3/4"W x 7 1/2"L x 1 1/4"H)
	<b>KNOBH37 - Red Rust Antique</b> (1.38"W x 1 1/4"H)
	<b>PULLH38 - Vibra Black Nickel - 128mm C/C</b> (1 1/4"W x 5 1/8"L x 1 3/8"H)
	<b>PULLH39 - Vibra Black Nickel - 96mm C/C</b> (1 1/8"W x 3 7/8"L x 1 1/8"H)
	<b>KNOBH40 - Black</b> (1 1/8"W x 1 1/4"L x 1/2"H)
	<b>PULLH41 - Black - 5 1/2" C/C</b> (1 1/16"W x 7 1/8"L)
	<b>PULLH42 - Black - 96mm C/C</b> (1 1/8"W x 4 1/4"L x 1 1/8"H)
	<b>KNOBH43 - Windsor Antique</b> (1.88"W x 1.08"L)
	<b>PULLH44 - Vibra Black Nickel</b> (2 1/8"W x 1 1/2"L x 5/8"H)
	<b>PULLH45 - Vibra Black Nickel - 3" C/C</b> (4 1/4"W x 1 1/2"L x 5/8"H)
	<b>KNOBH46 - Vibra Black Nickel</b> (1"W x 1 1/4"L x 7/8"H)
	<b>PULLH47 - Vibra Black Nickel - 2 1/2" C/C</b> (3"W x 1/2"L x 5/8"H)
	<b>PULLH50 - Satin Nickel - 5" C/C</b> (5/16"W x 5"L x 1 1/4"H)
	<b>PULLH51 - Stainless Steel - 1" C/C</b> (5/16"W x 2"L x 7/16"H)

**DESCRIPTION MODEL**  
**HARDWARE - DECORATIVE PULLS AND KNOBS (cont'd)**

	<b>PULLH52 - Stainless Steel - 7.38" C/C</b> (3/8"W x 8 1/16"L x 7/8"H)
	<b>PULLH53 - Satin Nickel - 96mm C/C</b> (5/8"W x 5"L x 1 7/16"H)
	<b>KNOBH54 - Black Nickel with Brown Glaze</b> (1 1/4"W x 1 1/8"H)
	<b>PULLH55 - Black Nickel with Brown Glaze - 4 1/2" C/C</b> (7/16"W x 5 1/8"L)
	<b>PULLH56 - South Haven Antique - 128mm C/C</b> (5 3/8"L)
	<b>KNOBH57 - South Haven Antique</b> (1 1/4")
	<b>KNOBH58 - Oil Rubbed Bronze</b> (1 1/4"W x 1"H)
	<b>PULLH59 - Oil Rubbed Bronze - 128mm C/C</b> (1 1/4"W x 6 1/8"L x 1 3/8"H)
	<b>PULLH60 - Oil Rubbed Bronze - 96mm C/C</b> (4 7/8"W x 2"L x 7/8"H)
	<b>PULLH61 - Black - 96mm C/C</b> (7/16" x 4 15/16"L)
	<b>KNOBH62 - Black</b> (2 1/8"W x 2"L x 5/8"H)
	<b>PULLH63 - Satin Nickel - 96mm C/C</b> (1/2"W x 4 1/8"L x 1 1/6"H)
	<b>PULLH64 - Satin Nickel - 3" C/C</b> (1/2"W x 4 9/16"L x 15/16"H)
	<b>KNOBH65 - Stainless Steel</b> (0.088")
	<b>PULLH66 - Black Nickel - 9" C/C</b> (7/8"W x 9 1/4"L)
	<b>PULLH70 - Brushed Nickel - 113mm C/C</b> (1 3/4"W x 6"L x 3/4"H)
	<b>PULLH71 - Brushed Nickel - 32mm C/C</b> (1 3/4"W x 1 3/4"L x 3/4"H)

- Larger pulls may not be compatible with raised profile or 5-piece drawer fronts on face frame openings of 9" wide or less.
- Screws included with each hardware piece.
- See page 77 for 5-piece drawer front dimensions when specifying decorative hardware.

**HARDWARE - FAUX HINGES**  
**HINGEFH1 - Antique Brass Faux Barrel Hinge**  
**HINGEFH2 - Pewter Faux Barrel Hinge**  
**HINGEFH3 - Black Faux Strap Hinge**



HINGEFH1  
HINGEFH2



HINGEFH3

- Faux Strap Hinge: All 12" - 30" high doors use 2 hinges. All 36" high and above use 3 hinges.
- Faux Barrel Hinge: All 12" - 30" high doors use 2 hinges. All 42" high and above use 3 hinges.
- Requires field installation.
- For use with LaGrange door style.

**DESCRIPTION**  
**ACCESSORIES**

**MODEL**

**BASE MIXER KIT**



**MIXKITFHSC18**

**MIXKITFHSC21**

**MIXKITFHSC24**

- Smart Stop closing feature.
- Mixer shelf will be 3/4" thick natural finished veneer plywood, mixer shelf dimensions:  
18" wide: 11 3/4" wide x 20" deep.  
21" wide: 14 3/4" wide x 20" deep.  
24" wide: 17 3/4" wide x 20" deep.
- Maximum Weight Capacity for Mixer Shelf: 60 lbs.
- Mixer shelf locks in the fully open position. Release brackets lower the mixer shelf back into the cabinet.
- When in closed position, clearance above shelf is 17 5/8"; clearance below shelf is 7 3/4".

**LOGIX**

**BASE PAN STORAGE**

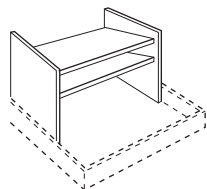

**BPS24**

**BPS30**

**BPS36**

Model	Application
BPS24	24" Base
BPS30	30" Base
BPS36	36" Base

- Roll tray not included.
- Insert consists of solid Maple sides and shelves. Back is edgebanded plywood.

**LOGIX**

**BASE WASTEBASKET LIDS**

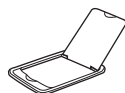

**BWBLID**

**BWBFHLID**

- Designed to be used with the BWB trash units.
- Sold individually.
- BWBLID fits 35 quart wastebaskets. BWBFHLID fits 50 quart wastebaskets.

**BROOM CLIP**

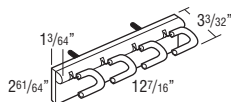

**BRMCLP**

**LOGIX**

**DESCRIPTION**

**MODEL**

**CABMAT™**

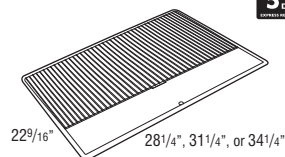

**CABMAT30**

**CABMAT33**

**CABMAT36**

- Designed with a slope to capture spills and is removable for cleaning.
- See CabMat™ modification for easy size selection by cabinet model.
- Not trimmable. Can also be used in wider cabinets but will create a small void of unprotected area along the end panels.

**LOGIX**

Model	Liquid Capacity		Cabinet Size	
	Quarts	Liters	Width	Depth
CABMAT30	4.2	3.9	30"	24"
CABMAT33	4.6	4.3	33"	24"
CABMAT36	5.0	4.7	36"	24"

**CABMAT™ VANITY**

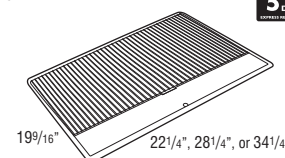

**CABMATV24**

**CABMATV30**

**CABMATV36**

- Designed with a slope to capture spills and is removable for cleaning.
- See CabMat™ modification for easy size selection by cabinet model.
- Not trimmable. Can also be used in wider cabinets but will create a small void of unprotected area along the end panels.

**LOGIX**

Model	Liquid Capacity		Cabinet Size	
	Quarts	Liters	Face Frame Opening	Depth
CABMATV24	2.5	2.4	21"-24"	21"
CABMATV30	3.3	3.1	27"-30"	21"
CABMATV36	3.9	3.7	33"	21"

DESCRIPTION

MODEL

COOKING UTENSIL DIVIDER



- CUDD24
- CUDD30
- CUDD36

• Pre-assembled natural wood drawer insert (does not fit roll trays).

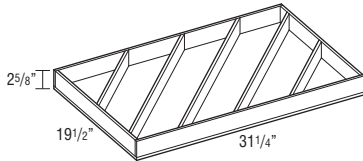
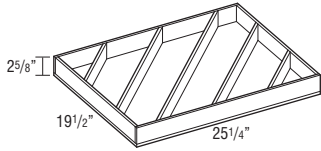
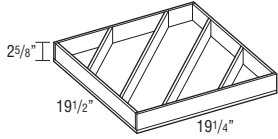

CUTLERY INSERT WOOD ORGANIZER



- CIW15
- CIW18
- CIW21
- CIW24

Model	Application
CIW15	15" Base
CIW18	18" Base
CIW21	21" Base
CIW24	24" Base

- Pre-assembled natural wood drawer insert.
- CIW also available installed in B \_\_ CIW, B \_\_ RTCIW, and 4DB \_\_ CIW. See pages 178, 191, and 236.
- Place a cabinet with a CIW next to the dishwasher for convenience.

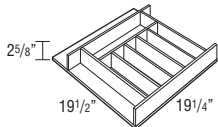
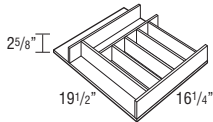
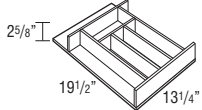
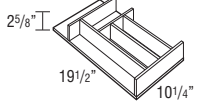

DESCRIPTION

MODEL

WOOD TIERED CUTLERY DIVIDER DRAWER, 15", 18", 21", and 24"



- WTCD15
- WTCD18
- WTCD21
- WTCD24

Model	Application
WTCD15	15" Base
WTCD18	18" Base
WTCD21	21" Base
WTCD24	24" Base

- Replaces standard drawer. Uses existing cabinet member drawer hardware.
- Requires field installation of drawer front.
- For use with 24" deep cabinets only.
- Exterior WTCD drawer box height is 3 3/4", interior height of top and bottom tier is 1 3/8".
- Top divider slides front-to-back.

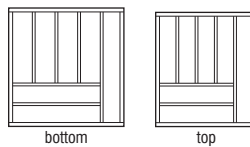
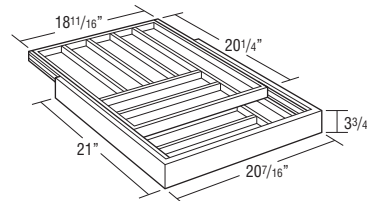
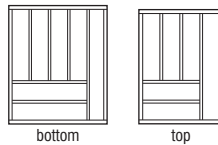
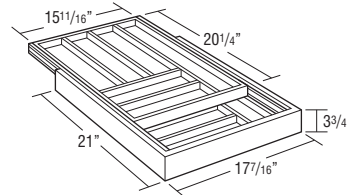
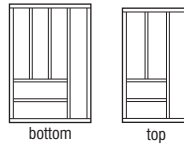
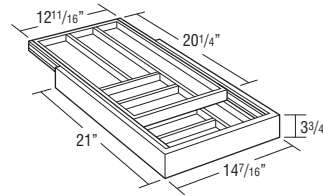
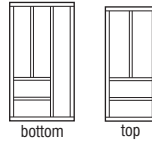
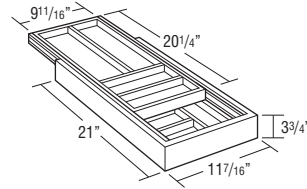

**DESCRIPTION**

**WOOD TIERED K-CUP\* DRAWER**

**MODEL**

**KCUP18**

- Holds 40 K-Cups.
  - Exterior Wood Tiered K-Cup drawer box height is 3 3/4", interior height of top tier is 1 5/8", and interior height of bottom tier is 1 3/8".
  - The Wood Tiered K-Cup Drawer is compatible with K-Cup pods only.
  - Replaces standard drawer. Uses existing cabinet member drawer hardware.
  - Requires field installation of drawer front.
  - Only for use with 24" deep cabinets that are 18" wide or have a 15" wide frame opening for the drawer.
  - Top divider slides front-to-back.
- \*K-Cup is a registered trademark of Keurig Green Mountain, Inc.

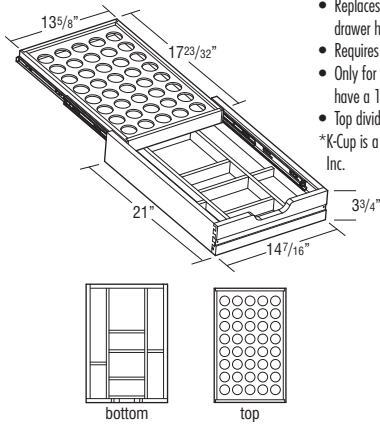

**EDGE BANDING**



**EDGE BAND 1OWD**

**EDGE BAND 1OP**

**EDGE BAND 1ONML**

**EDGE BAND 1ONIP**

**EDGE BAND 1OWHL**

- Edgebanding will come in a 10' length.
- Finger joints may be visible on unfinished veneer and clear coated edgebanding.
- Edgebanding does not come pre-glued.
- EDGE BAND 1OWD is unfinished veneer, available in Alder, Cherry, Hickory, Maple, Oak, and Rustic Alder.
- EDGE BAND 1OP is available in Arctic, Antler, Elk, High Gloss White, High Gloss White with Metallic, Obsidian, and Wharf.
- EDGE BAND 1ONML is Natural Maple Laminate.
- EDGE BAND 1ONIP is clear coated veneer for use with APC natural interiors.
- EDGE BAND 1OWHL is White Laminate.

**EXTERIOR SHELVES, 12" DEEP**

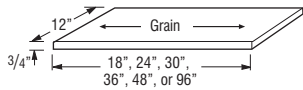

**ES1218**

**ES1224**

**ES1230**

**ES1236**

**ES1248**

**ES1296†**

- Wood 3/4" panels are veneered furniture board finished both sides, and front and side edges (back edge is not finished).
  - Not available in wood grain laminates.
  - Shelves can be ordered in APC.
- †5 day Express Response not available on items over 48".

**Custom Modifications**

ID	RD
•	•

**Finish Techniques**

Distressing	Heirlooming

**Species Availability (Wood)**

Alder	Rustic Alder	Cherry	Hickory	Maple	Oak
•	Alder	•	•	•	•

**Species Availability (All Laminates)**

High Gloss	Horiz. Grain on Maple	Vert. Grain on Maple	Vert. Grain on Cherry	Vert. Grain on Hickory	Vert. Grain on Oak	Thermofoil
box color	box color	box color	box color	box color	box color	box color

**DESCRIPTION**

**EXTERIOR SHELVES, 18" DEEP**



**MODEL**

**ES1818**

**ES1824**

**ES1830**

**ES1836**

**ES1848**

**ES1896†**

- Wood 3/4" panels are veneered furniture board finished both sides, and front and side edges (back edge is not finished).
  - Not available in wood grain laminates.
  - Shelves can be ordered in APC.
- †5 day Express Response not available on items over 48".

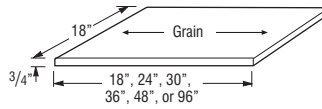

**Custom Modifications**

ID	RD
•	•

**Finish Techniques**

Distressing	Heirlooming

**Species Availability (Wood)**

Alder	Rustic Alder	Cherry	Hickory	Maple	Oak
•	Alder	•	•	•	•

**Species Availability (All Laminates)**

High Gloss	Horiz. Grain on Maple	Vert. Grain on Maple	Vert. Grain on Cherry	Vert. Grain on Hickory	Vert. Grain on Oak	Thermofoil
box color	box color	box color	box color	box color	box color	box color

**EXTERIOR SHELVES, 21" DEEP**



**ES2118**

**ES2124**

**ES2130**

**ES2136**

**ES2148**

**ES2196†**

- Wood 3/4" panels are veneered furniture board finished both sides, and front and side edges (back edge is not finished).
  - Not available in wood grain laminates.
  - Shelves can be ordered in APC.
- †5 day Express Response not available on items over 48".

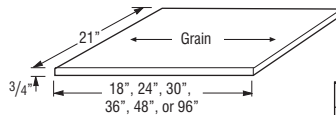

**Custom Modifications**

ID	RD
•	•

**Finish Techniques**

Distressing	Heirlooming

**Species Availability (Wood)**

Alder	Rustic Alder	Cherry	Hickory	Maple	Oak
•	Alder	•	•	•	•

**Species Availability (All Laminates)**

High Gloss	Horiz. Grain on Maple	Vert. Grain on Maple	Vert. Grain on Cherry	Vert. Grain on Hickory	Vert. Grain on Oak	Thermofoil
box color	box color	box color	box color	box color	box color	box color

**DESCRIPTION**

**EXTERIOR SHELVES,  
24" DEEP**



**MODEL**

- ES2418
- ES2424
- ES2430
- ES2436
- ES2448
- ES2496†

- Wood 3/4" panels are veneered furniture board finished both sides, and front and side edges (back edge is not finished).
  - Not available in wood grain laminates.
  - Shelves can be ordered in APC.
- †5 day Express Response not available on items over 48".

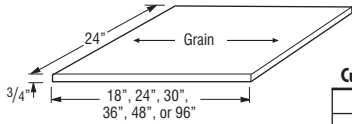

**Custom Modifications**

ID	RD
•	•

**Finish Techniques**

Distressing	Heirlooming

**Species Availability (Wood)**

Alder	Rustic Alder	Cherry	Hickory	Maple	Oak
•	•	•	•	•	•

**Species Availability (All Laminates)**

High Gloss box color	Horiz. Grain on Maple box color	Vert. Grain on Maple box color	Vert. Grain on Cherry box color	Vert. Grain on Hickory box color	Vert. Grain on Oak box color	Thermofoil box color

**FULL DEPTH SHELVING**  
To Fit 12" Deep Cabinets



SK912

- SK1212
- SK1512
- SK1812
- SK2112
- SK2412
- SK2712
- SK3012
- SK3312
- SK3612
- SK3912
- SK4212
- SK4812

- One shelf, 10 7/32" deep.
- Each kit includes 8 shelf pegs.
- Shelving material specific to construction option. See page 36 for construction details.
- Specify material when ordering.
- Full Depth Shelves will be shipped separate from the cabinet.
- If matching interior is desired, order shelf kit (SK\_\_\_\_) with Matching Interior Plywood (MIP) modification.

**Custom Modifications**

ID	MIP	RD	WLI
•	•	•	•

**Construction Upgrades**

APC
•

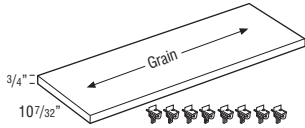

**DESCRIPTION**

**FULL DEPTH SHELVING**  
To Fit 24" Deep Cabinets



**MODEL**

- SK924
- SK1224
- SK1524
- SK1824
- SK2124
- SK2424
- SK2724
- SK3024
- SK3324
- SK3624
- SK3924
- SK4224
- SK4824

- One shelf, 22 7/32" deep.
- Each kit includes 8 shelf pegs.
- Shelving material specific to construction option. See page 36 for construction details.
- Specify material when ordering.
- Full Depth Shelves will be shipped separate from the cabinet.
- If matching interior is desired, order shelf kit (SK\_\_\_\_) with Matching Interior Plywood (MIP) modification.

**Custom Modifications**

ID	MIP	RD	WLI
•	•	•	•

**Construction Upgrades**

APC
•

**GLASS SHELF KIT,  
6" & 9" DEEP**

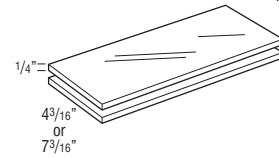

- JGSK1206
- JGSK1506
- JGSK1806
- JGSK2106
- JGSK2406
- JGSK2706
- JGSK3006
- JGSK3306
- JGSK3606
- JGSK1209
- JGSK1509
- JGSK1809
- JGSK2109
- JGSK2409
- JGSK2709
- JGSK3009
- JGSK3309
- JGSK3609

- JGSK cannot be trimmed.
- Kit includes two 1/4" tempered shelves.
- Example: JGSK1206 = 10 9/32" x 4 3/16" to fit W1230x6 cabinet.
- Not compatible with the FFD modification.



**DESCRIPTION**

**MODEL**

**GLASS SHELF KIT,  
12" DEEP**

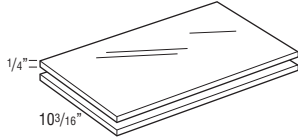

- JGSK912
- JGSK1212
- JGSK1512
- JGSK1812
- JGSK2112
- JGSK2412
- JGSK2712
- JGSK3012
- JGSK3312
- JGSK3612

- JGSK cannot be trimmed.
- Kit includes two 1/4" tempered shelves.
- Example: JGSK1512 = 13 9/32" wide x 10 3/16" deep fits in W1530x12 Deep Cabinet.

**Custom Modifications**

ID	RD
•	

**GLASS SHELF KIT,  
DIAGONAL**

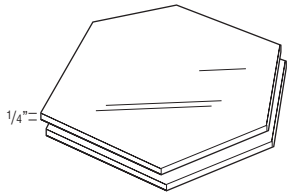

- JGSKDW24 (Fits DW..2424)
- JGSKDW27 (Fits DW..2727)

- JGSK cannot be trimmed.
- Kit includes two 1/4" tempered shelves.
- Not available for 24" and 27" high Diagonal Wall cabinets. Shelf will not fit through door opening.
- Not available for Diagonal Wall cabinets specified with Peninsula modification.

**ANGLED HEAT SHIELDS**



**ANGLHEATSHIELD  
ANGLSHIELDSS**

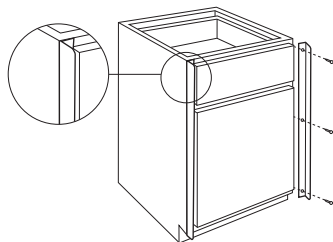
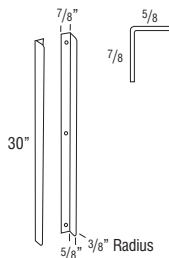

- ANGLHEATSHIELD is a pair of 1/16" thick, white powder coated metal shields.
- ANGLSHIELDSS is a pair of 1/16" thick, stainless steel metal shields.
- Heat Shield is used to deflect heat from self-cleaning ovens away from cabinet doors and drawer fronts.
- For use when additional 1/8" cannot be added to the oven manufacturer's recommended space requirement.
- Cabinet door cannot be hinged on the same side as the angled heat shield, not compatible with double door cabinets. Installs on the front of the face frame of each cabinet adjacent to the oven.

**DESCRIPTION**

**MODEL**

**STRAIGHT HEAT SHIELDS**



**STRTHEATSHIELD  
STRTHSHIELDSS**

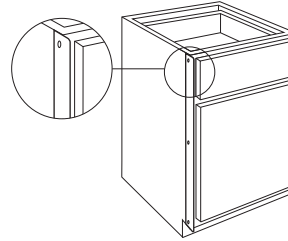
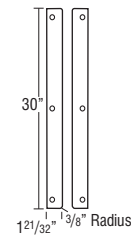

- STRTHEATSHIELD is a pair of 1/16" thick, white powder coated metal shields.
- STRTHSHIELDSS is a pair of 1/16" thick, stainless steel metal shields.
- Heat Shield is used to deflect heat from self-cleaning ovens away from cabinet doors and drawer fronts.
- For use when additional 1/8" can be added to the oven manufacturer's recommended space requirement.
- Installs on the side of the face frame of each cabinet adjacent to the oven.

**K-CUP\* INSERT**

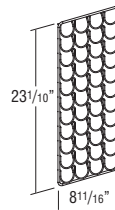

**WBCPOKCUP**

- Holds 44 K-Cups, compatible with K-Cup pods only.
- Wire K-Cup rack for easy field installation on either the left or right side. Compatible with all heights of 3" wide box column pull-outs (WBCPO., see page 144). Depending on height of pull-out, shelves can be used above or below insert for additional storage:
  - 30" and 33" high include 4 shelves, not compatible with insert.
  - 36" and 39" high include 5 shelves, one shelf recommended for use with insert.
  - 42" high includes 6 shelves, two shelves recommended for use with insert.

\*K-Cup is a registered trademark of Keurig Green Mountain, Inc.

**LID ORGANIZERS**



**LID ORGANIZERS**



- LO24DPRT30
- LO24DPRT33
- LO24DPRT36

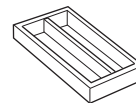
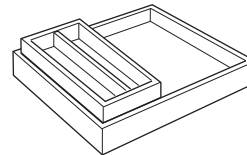

**LO**

- LO24DPRT30, LO24DPRT33, and LO24DPRT36 include roll tray and installation hardware.

**LOGIX**

**LINEN CLOSET HAMPER LINER**



**LCHAMPERLNR**

- Replacement cloth liner for use with LCRH188421, see page 342.

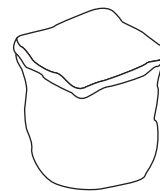

DESCRIPTION

MODEL

OVEN INSTALLATION KIT



OCINSTALLKIT

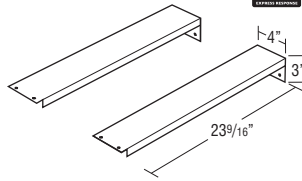

- Recommended for supporting built-in appliances such as ovens, microwaves, and warming drawers. Refer to appliance manufacturer specifications for installation requirements.
- Weight limit is 400 lbs. per pair.

PEGGED DISH ORGANIZER



PDO (8 Posts & Board)

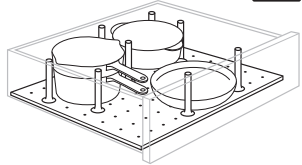

PDOPOSTS (4 Posts)

- For use in 36" wide drawer base cabinets in 6 3/8" or 10" deep drawers, trimmable for cabinets less than 36" wide. Not recommended for use in roll trays.
- Pegged Board is 19/32" thick.
- 29 15/16" x 19 1/2".
- Posts are 6" high.

LOGIX

POTS & PANS PULL-OUT



PPP

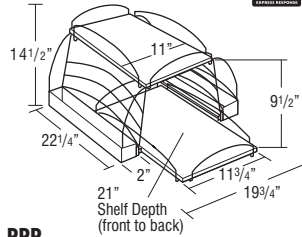

- For use in 24" wide cabinets.

PPP30

- For use in 30" wide cabinets.

PPP

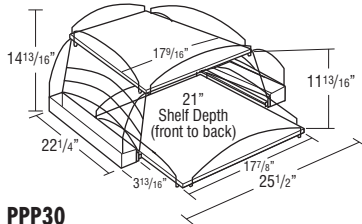

PPP30

LOGIX

DESCRIPTION

MODEL

POWERGLIDE™ COMPACT DRAWER OUTLET

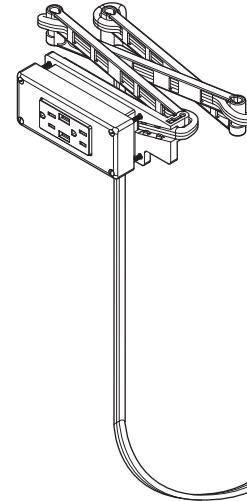

DRWPWR1

- Outlet has a total rated capacity of 15 amps.
- Includes two 120V electrical plug-ins and two 2.1 amp rated USB charging ports.
- Cord has 3 ft. of length hanging freely from back mounting bracket. The cord is 14 gauge wire and features a standard 3-prong plug and is required to be plugged into an approved AFCI/GFCI dual function outlet for all applications.
- Outlet is ETL approved-compliant for electrical and other safety standards to U.S. and Canadian safety including UL standards.
- Requires field installation including a 4.25" x 2.13" square hole to be cut into the back of the drawer box.
- Outlet face plate measures 5.22" x 2.3" and will extend 3/4" into drawer box.
- A minimum drawer box height of 2 5/8" is required for installation.
- For use in base cabinet widths of 18" to 36".
- For use in cabinet depths of 15", 18", 21", and 24".
- Also available as an installed modification, see DRWPWR on page 50.

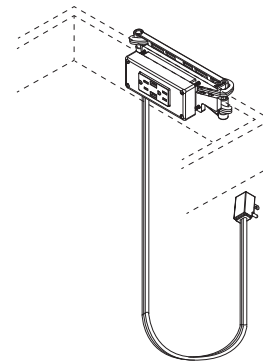

POWER POD

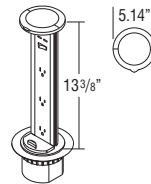

LOGIX

JPWRPODBK (Black)

JPWRPODSS (Stainless Steel)

JPWRPODGM (Gun Metal Black)

- Includes: independent power switch, three electrical sockets, and two USB ports (located above power switch).
- 18" of clearance required below surface mount location; and 3 9/16" diameter hole is required in countertop to install.
- This item requires field installation. This accessory cannot be installed above drawers.
- Safe for countertop installation: rated IP54-splash proof from splashing water and water jets per IPX waterproof specifications; and is ETL approved-compliant for electrical and other safety standards to North America safety including: UL, ANSI, CSA, ASTM, and NFPA standards.
- When installed, top lip of strip sits on top of countertop with a pivoting handle. Handle is pulled up to bring bottom of power strip to countertop.
- Cord is 8 ft. long and features a standard 3-prong plug for use in any household outlet. 10 amps.

SINK BASE CADDY



SBCADDY

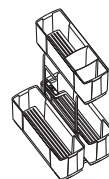

LOGIX

- Caddy is removable and portable.
- Recommended for use in cabinets 18" and wider.
- Caddy dimensions are: 9 15/16" wide x 18 5/16" tall x 18 5/8" deep.
- Caddy fits in cabinets with a minimum: 12" wide x 20 1/2" high frame opening x 21" deep cabinet.



## DESCRIPTION

### SLIDING TOWEL RACK

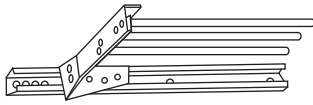

## MODEL

### STR

- Metal.
- 5" wide x 17 3/4" long x 1 1/2" high.
- Fits in any sink cabinet.

### NEW EZ-ORG™ MODULAR PULL-OUT RACKS

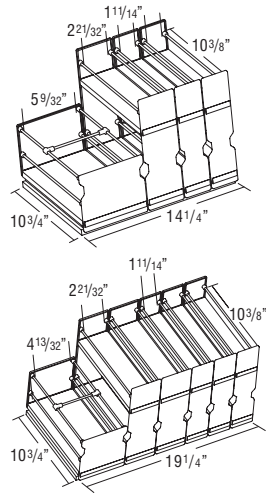

### EZORG18 EZORG24

- EZORG18 includes four pull-out racks installed onto a wood base for use in an 18" wide or wider cabinet. Outside rack dimensions:  
one 5 7/8" wide x 5 3/4" high  
one 3 1/4" wide x 10 3/4" high  
two 2 3/8" wide x 10 3/8" high
- EZORG24 includes six pull-out racks installed onto a wood base for use in a 24" wide or wider cabinet. Outside rack dimensions:  
one 5" wide x 5 3/8" high  
two 3 1/4" wide x 10 3/4" high  
three 2 3/8" wide x 10 3/8" high.
- Entire pull-out must be installed as one unit, cannot remove racks from wood base for individual installation.
- Racks feature natural finish wood shelves with wire racks and frosted front and back panels. Guides are full extension and do not feature Smart Stop.
- Maximum Weight Capacity:  
2 3/8" and 3 1/4" wide racks: 7 lbs.  
5" and 5 7/8" wide racks: 20 lbs.
- Must be installed on the floor of the cabinet. Cannot be installed on an adjustable shelf.
- Field installation requires attaching wood base to cabinet bottom with pre-drilled mounting holes, includes 4 screws and instructions.
- Installation height clearance of 12" minimum is recommended.

## SPICE RACKS

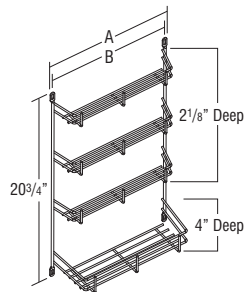

### SRCH12 SRCH15 SRCH18

Model	A	B	Fits
SRCH12	7 7/8"	8 13/50"	B15, B30, B33
SRCH15	10 5/8"	11"	B18, B36
SRCH18	13 5/8"	14"	B21, B24 L or R

**A = Hole Centers Width**  
**B = Outside Overall Widths**

- Designed for Base cabinets only. Mounts to door top and bottom rails.
- Spice Rack is chrome.

## SPICE RACK PULL-DOWN



### SPD18

- Spice Rack Pull-down dimensions: 8 15/16" high x 14 13/16" wide x 10 5/16" deep.
- Maximum Weight Capacity: 15 lbs.
- Must be installed on the floor of the cabinet. Cannot be installed on an adjustable shelf.

## SHELF PULL-DOWN

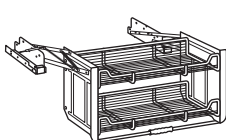

### SHLFPD36

- Shelf Pull-down dimensions: 18 11/64" high x 28 1/4" wide x 8 1/2" deep.
- Clearance dimensions: 19 3/8" high x 15 3/8" wide.
- Maximum Weight Capacity: 26 lbs.
- Must be installed on the floor of the cabinet. Cannot be installed on an adjustable shelf.

## DESCRIPTION

### TABLET HOLDER

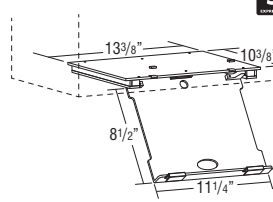

## MODEL

### TABLEHLDR

- Mounts under 15" wide cabinet or wider.
- Designed for cabinets 12" deep or deeper.
- Features an acrylic mounting base and pull-down tablet holder tray.
- Tray is movable forward and backward with a slight side to side rotation, and can be utilized at any position.
- Tray has side cut-outs for a charging cord and can be used to store most tablets when closed, depending on overall thickness, width, height, and weight of the tablet.
- Maximum dimensions for tablet: 11 1/4" x 8 1/2" x 1 1/8" thick. Maximum tablet weight is 3 1/2 lbs.
- Tablet Holder has an overall height of 1 17/32" when installed and in closed position (measured from the bottom panel of the cabinet), 0.78" visible from front of cabinet when closed.
- Installation instructions included.

LOGIX

### NEW TOEKICK VACUUM

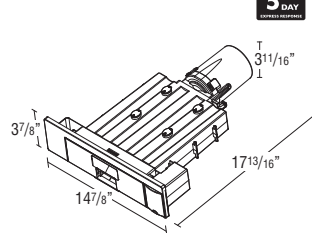

### TOEKICKVAC

- 120V compact vacuum cleaner for field installation into the toekick area of base cabinets. Toekick area must be routed for vacuum to be inserted and screwed into place.
- Flooring installation must be compatible with the vacuum by ensuring the bottom of the cabinet is flush with the top of the flooring to allow clearance for the tray to open to access the bag and filter. The flooring should either be installed under the cabinets or the cabinets can be raised to the flooring level.
- Vacuum is 120V-60Hz, rated current of 5 amps, and rated input power is 650W.
- Cord is 10 ft. from the right side of the unit and features a standard 3-prong plug for use in any household outlet.
- Built-in switch can be gently tapped to turn the unit on, a 10 second timer will automatically turn the unit off.
- Should not be installed in a sink base, bathroom, outdoors, or in other wet environments. Do not expose to moisture, rain, or snow. Do not pick up water or sweep water into the vacuum.
- For installation in the front toekick, cabinet must have a minimum depth of 22" and a minimum width of 18". For installation in an end panel, cabinet must have a minimum depth of 21" and a minimum width of 21".
- TOEKICKVAC includes one reusable 0.5 gallon vacuum bag, one HEPA filter, and 4 disposable bags.
- Plastic faceplate features a stainless steel look.
- An air exhaust opening equal to 8" sq (50 cm sq) is required in an area adjacent to the TOEKICKVAC at the rear or side of the cabinet, where cabinets are tight to the floor.

## TILT-OUT TRAYS, PLASTIC

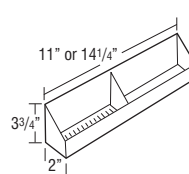

### TOT15 TOT18

- Kit includes two white plastic trays and one pair of tilt-out hinges that attaches to the inside of the false panel.
- One tilt-out tray per false panel on cabinets less than 30" wide and greater than 36" wide, two tilt-out trays attached to one false panel on 30"-36" wide cabinets.
- Clean using a mild soap and water. Avoid scalding water.

Model	Width	Application
TOT15	11"	SB30, SB33
TOT18	14 1/4"	SB36, SB39, SB42, SB24, SB27, SB48

**DESCRIPTION**

**TILT-OUT TRAYS, STAINLESS STEEL**

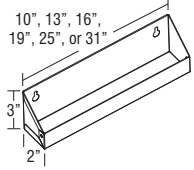

**TOTSS**

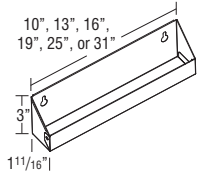

**TOTSSS**

**MODEL**



- TOTSS10
- TOTSS13
- TOTSS16
- TOTSS19
- TOTSS25
- TOTSS31

- TOTSSS10
- TOTSSS13
- TOTSSS16
- TOTSSS19
- TOTSSS25
- TOTSSS31

- Contains one tray and one pair of tilt-out hinges that attaches to the inside of the false panel.
- One tilt-out tray per false panel.
- TOTSS is available in standard depth (2" deep) and TOTSSS is a slim version (1 1/16" deep) to be used in narrow spaces.
- Standard trays protrude 1 1/16" into cabinet. Slim trays protrude 3/4" into cabinet.

Model	Width	Application
TOTSS10 TOTSSS10	10"	ACS36, VSB15, VACSF
TOTSS13 TOTSSS13	13"	SB39, SB45, ACS39, VSB18, VSB39, 2VSD36, 2VSD42, 2VSD48, VSD60, 6VSD42FP
TOTSS16 TOTSSS16	16"	SB21, SB42, SB45, SB48, VSB21, VSB42, VSB45, 2VSD45, VSD54FP, VSD60FP, VS3D54, VS3D60
TOTSS19 TOTSSS19	19"	SB24, SB27, SB30, SB33, SB48, ACS42, VSB24, VSB27, VSB48, VSB54, 2VSD54, 2VSD60, 2VSD57/60, VSD24FP, VSD27FP, 6VSD48FP, 6VSD54FP, 6VSD57FP, 6VSD60FP, 8VSD48FP, 8VSD60FP
TOTSS25 TOTSSS25	25"	SB30, SB33, SB36, SB39, VSB30, VSB33, VSB60, VSD30FP, VSD33FP, VSD42FP, VSD45FP
TOTSS31 TOTSSS31	31"	SB36, SB42, VSB36, VSD36FP, VSD48FP

**TRAY DIVIDER, CHROME**



**CTDK**

- CTDK: Includes 1 divider, 3 clips, and 3 screws.
- Tray divider is chrome wire.

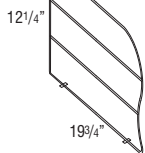

**DESCRIPTION**

**TRAY DIVIDER KIT**



- TDKIT15
- TDKIT18
- TDKIT21
- TDKIT24
- TDKIT27

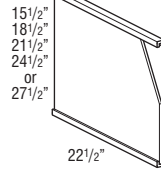

- Cabinets need full top and bottom for field installation of tray divider kits.
- Dividers are sized for a 24" deep cabinet, depth can be modified during field installation. Installation screws included.
- Tray dividers are Natural Maple laminated plywood. When specified with APC, tray dividers are clear coated veneer plywood. When specified with APC and WLI, dividers are white laminated plywood. Rails are always Natural Maple.

Model	Application	Wall Cabinets	Tall Cabinets — Upper Section
TDKIT15	Fits 15" high frame opening	Most 18" high wall cabinets	Upper section of 84" high utility, oven cabinets with 15" high frame opening
TDKIT18	Fits 18" high frame opening	Most 21" high wall cabinets	Upper section of 87" high utility, oven cabinets with 18" high frame opening
TDKIT21	Fits 21" high frame opening	Most 24" high wall cabinets	Upper section of 90" high utility, oven cabinets with 21" high frame opening
TDKIT24	Fits 24" high frame opening	Most 27" high wall cabinets	Upper section of 93" high utility, oven cabinets with 24" high frame opening
TDKIT27	Fits 27" high frame opening	Most 30" high wall cabinets	Upper section of 96" high utility, oven cabinets with 27" high frame opening

**TRAY DIVIDER ROLL-OUT KIT**



- TDR012
- TDR015

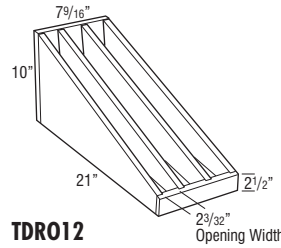

**TDR012**

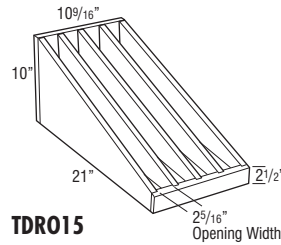

**TDR015**

- TDR012: 2 removable dividers (3 compartments).
- TDR015: 3 removable dividers (4 compartments).
- Utilizes Smart Stop undermount guides and bumpers for door protection.
- Installation hardware included.

L O G I X

**UTILITY EASY ACCESS BASKETS**



- UEASBSK15
- UEASBSK18

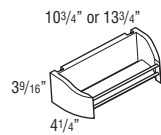

L O G I X

- Only for use to add baskets to a UEAS cabinet.
- Mounting hardware not included.

**DESCRIPTION**

**VANITY CHROME ROLL-OUT RACK**

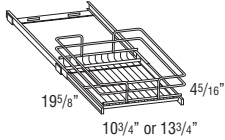

**L G I X**

**MODEL**

**VCRR1521**  
**VCRR1821**

- Requires installation to fixed shelf or cabinet bottom in a 21" or 24" deep cabinet.
- VCRR1521 recommended for use in VB153221, VB153421, DDD152921.
- VCRR1821 recommended for use in VB183421, 2VSD363221, 2VSD363421, VSD303121, VSD303421, LC188421 (lower section), VU188421, VU188421H, DDD182921.
- Roll-out is full extension.

**VANITY WASTEBASKET KIT**



**L G I X**



**VWB**

- Bottom mount zinc colored Smart Stop guide with 20 quart gray wastebasket inserted in chrome support.
- Dimension of insert: 8.5" wide x 16.7" tall x 17.7" deep.

**WALL SUSAN KITS**

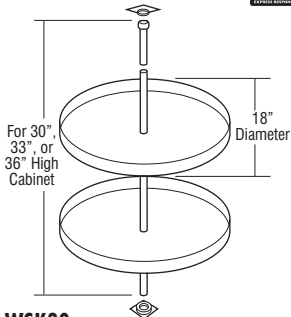

**WSK30**  
**WSK33**  
**WSK36**

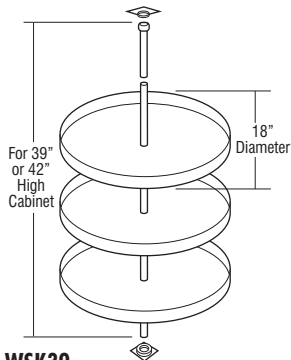

**WSK39**  
**WSK42**



**WSK30**  
**WSK33**  
**WSK36**  
**WSK39**  
**WSK42**

- 30"-36" kits include pole and two 18" diameter plywood shelves. 39" and 42" kits include pole and three 18" diameter plywood shelves.

**DESCRIPTION**

**WINE GLASS HOLDERS**

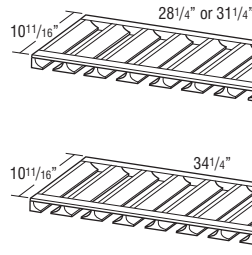

**MODEL**

**WGH30** (7 slots)  
**WGH33** (7 slots)  
**WGH36** (8 slots)

- Maximum wine glass base is 3" diameter.
- Wine Glass Holder is finished.
- May be trimmed to fit smaller cabinets.
- Designed for installation under a wall cabinet (between end panels and behind face frame).

**Species Availability (Wood)**

	Rustic Alder	Cherry	Hickory	Maple	Oak
	•	•	•	•	•

**Species Availability (All Laminates)**

High Gloss	Horiz. Grain on Maple	Vert. Grain on Maple	Vert. Grain on Cherry	Vert. Grain on Hickory	Vert. Grain on Oak	Thermofoil
box color	box color	box color	box color	box color	box color	box color

**DESCRIPTION**  
**ROLL TRAY KITS**

**MODEL**

**ROLL TRAY KIT**

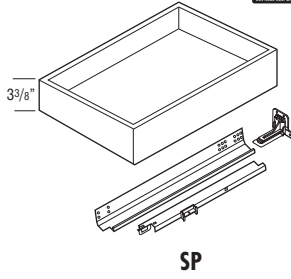

For 18" Deep Cabinets

- RT1218SP
- RT1518SP
- RT1818SP
- RT2118SP
- RT2418SP
- RT2718SP
- RT3018SP
- RT3318SP
- RT3618SP
- RT3918SP
- RT4218SP
- RT4518SP
- RT4818SP

For 21" Deep Cabinets

- RT1221SP
- RT1521SP
- RT1821SP
- RT2121SP
- RT2421SP
- RT2721SP
- RT3021SP
- RT3321SP
- RT3621SP
- RT3921SP
- RT4221SP
- RT4521SP
- RT4821SP

For 24" Deep Cabinets

- RT12SP
- RT15SP
- RT18SP
- RT21SP
- RT24SP
- RT27SP
- RT30SP
- RT33SP
- RT36SP
- RT39SP
- RT42SP
- RT45SP
- RT48SP

- RT\_ \_SP's include roll tray, roll tray brackets, hardware, screws, and installation instructions.
- 39"-48" wide Roll Tray Kits will contain 1 roll tray. QTY of 2 must be ordered to achieve a roll tray in both cabinet openings.

**Custom Modifications**

ID	RD
	•

**DESCRIPTION**

**MODEL**

**DEEP ROLL TRAY KIT**

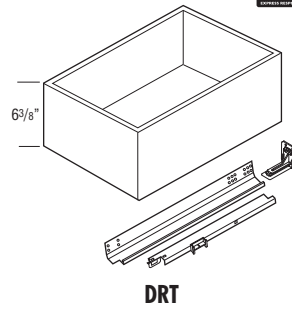

For 18" Deep Cabinets

- DRT1218
- DRT1518
- DRT1818
- DRT2118
- DRT2418
- DRT2718
- DRT3018
- DRT3318
- DRT3618
- DRT3918
- DRT4218
- DRT4518
- DRT4818

For 21" Deep Cabinets

- DRT1221
- DRT1521
- DRT1821
- DRT2121
- DRT2421
- DRT2721
- DRT3021
- DRT3321
- DRT3621
- DRT3921
- DRT4221
- DRT4521
- DRT4821

For 24" Deep Cabinets

- DRT12
- DRT15
- DRT18
- DRT21
- DRT24
- DRT27
- DRT30
- DRT33
- DRT36
- DRT39
- DRT42
- DRT45
- DRT48

- DRT\_ \_'s include deep roll tray, deep roll tray brackets, hardware, screws, and installation instructions.
- 39"-48" wide Deep Roll Tray Kits will contain 1 roll tray. QTY of 2 must be ordered to achieve a roll tray in both cabinet openings.

**Custom Modifications**

ID	RD
	•

**DESCRIPTION**

**MODEL**

**ROLL TRAY KIT – EASYTRAX™**

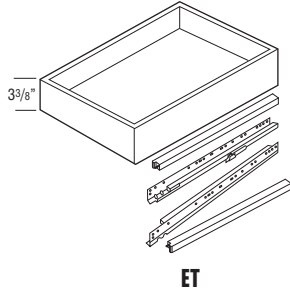

For 18" Deep Cabinets

- RT1518ET
- RT1818ET
- RT2118ET
- RT2418ET
- RT2718ET
- RT3018ET
- RT3318ET
- RT3618ET
- RT3918ET
- RT4218ET
- RT4518ET
- RT4818ET

For 21" Deep Cabinets

- RT1521ET
- RT1821ET
- RT2121ET
- RT2421ET
- RT2721ET
- RT3021ET
- RT3321ET
- RT3621ET
- RT3921ET
- RT4221ET
- RT4521ET
- RT4821ET

For 24" Deep Cabinets

- RT15ET
- RT18ET
- RT21ET
- RT24ET
- RT27ET
- RT30ET
- RT33ET
- RT36ET
- RT39ET
- RT42ET
- RT45ET
- RT48ET

- EasyTrax™ uprights are required, must be purchased separately (see page 428).
- RT-ET's contain roll tray, hardware, wooden hardware mounting bracket, screws and installation instructions.
- 39"-48" wide Roll Tray Kits will contain 1 roll tray. QTY of 2 must be ordered to achieve a roll tray in both cabinet openings.

**Custom Modifications**

ID	RD
	•

**DESCRIPTION**

**MODEL**

**DEEP ROLL TRAY KIT – EASYTRAX™**

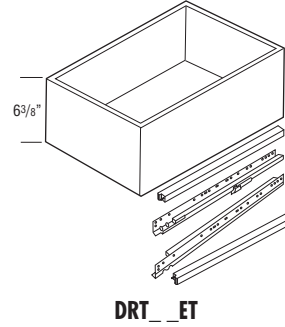

For 18" Deep Cabinets

- DRT1218ET
- DRT1518ET
- DRT1818ET
- DRT2118ET
- DRT2418ET
- DRT2718ET
- DRT3018ET
- DRT3318ET
- DRT3618ET
- DRT3918ET
- DRT4218ET
- DRT4518ET
- DRT4818ET

For 21" Deep Cabinets

- DRT1221ET
- DRT1521ET
- DRT1821ET
- DRT2121ET
- DRT2421ET
- DRT2721ET
- DRT3021ET
- DRT3321ET
- DRT3621ET
- DRT3921ET
- DRT4221ET
- DRT4521ET
- DRT4821ET

For 24" Deep Cabinets

- DRT12ET
- DRT15ET
- DRT18ET
- DRT21ET
- DRT24ET
- DRT27ET
- DRT30ET
- DRT33ET
- DRT36ET
- DRT39ET
- DRT42ET
- DRT45ET
- DRT48ET

- EasyTrax™ uprights are required, must be purchased separately (see page 428).
- DRT-ET's contain roll tray, hardware, wooden hardware mounting bracket, screws and installation instructions.
- 39"-48" wide Deep Roll Tray Kits will contain 1 roll tray. QTY of 2 must be ordered to achieve a roll tray in both cabinet openings.

**Custom Modifications**

ID	RD
	•

**DESCRIPTION**

**MODEL**

**EASYTRAX™ UPRIGHTS**



**ETUPRIGHT**

**ETUPRIGHTOV**

**ETUPRIGHT40.5**

**ETUPRCS**

**ETUPR40.5CS**

- EasyTrax™ system allows quick field installation of adjustable height roll trays with front and rear uprights to support roll tray guides.
- ETUPRIGHT contains 2 front and 2 rear uprights. QTY required: Base, Base Full Height, and 34 1/2" high Vanities = 1  
Utility Cabinets = 3  
42" and 48" wide cabinets = 2.
- ETUPRIGHTOV contains 2 front and 2 rear uprights. QTY required: Desk and 32" high Vanity = 1.
- ETUPRIGHT40.5 contains 2 front and 2 rear uprights. QTY required: 40 1/2" high Base cabinets = 1.
- ETUPRCS and ETUPR40.5CS recommended for DRT39ET-DRT48ET kits to secure drawer guide in ET system on cabinets with center stiles.

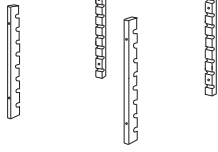

**ETUPRIGHT**

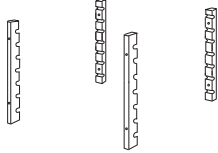

**ETUPRIGHTOV**

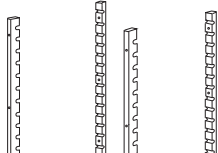

**ETUPRIGHT40.5**



**ETUPRCS  
ETUPR40.5CS**

**DESCRIPTION**

**MODEL**

**GUIDE KITS AND PARTS**

**DRAWER GUIDE KITS**



**DGK21DDFX**

**DGK24DDFX**

- Side-mount progressive full extension guide utilized on all drawers of DDFD cabinets.
- Maximum Weight Capacity: 125 lbs. per pair.
- Kit includes guide hardware for one drawer box (cabinets, drawer members wood vertical mounting rails and screws)  
Dimension refers to cabinet depth.

**DGK\_\_DDFX**

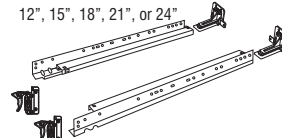

**DGKIT\_\_PG**

**DGKIT12PG**

**DGKIT15PG**

**DGKIT18PG**

**DGKIT21PG**

**DGKIT24PG**

- Undermount full extension Smart Stop Premium Guide (PG).
- Maximum Weight Capacity: 90 lbs. per pair.
- Kit includes guide hardware for one drawer box (cabinets and drawer members, sockets and screws)  
Dimension refers to cabinet depth.

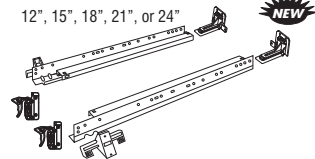

**DGKIT\_\_RTSP**

**DGKIT12RTSP**

**DGKIT15RTSP**

**DGKIT18RTSP**

**DGKIT21RTSP**

**DGKIT24RTSP**

- Undermount full extension Smart Stop Premium Guide utilized on roll trays.
- Maximum Weight Capacity: 90 lbs. per pair.
- Kit includes guide hardware for one drawer box (cabinets and drawer members, sockets and screws)  
Dimension refers to cabinet depth.

**DRAWER GUIDE  
BACK SOCKETS**



**BKSOCKET-PG**

**BKSOCKET-SP**

- BKSOCKET-PG used with Smart Stop drawer guides (12"-24" deep).
- BKSOCKET-SP used with Smart Stop roll tray guides.
- Sold in pairs.

**DRAWER GUIDE  
SPACER BLOCK**

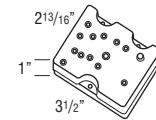

**SPACERBLK**

- Sold in pairs.
- For use with DGKIT..PG and DGKIT..SP kits when RD is used for depths other than in 3" increments.
- One SPACERBLK required for each inch of depth.
- Not required for use with 23", 20", 17", 14" depth.

**FALSE PANEL CLIPS**

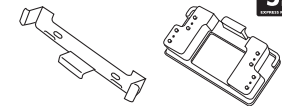

**FALSEPNLCLIP50**

**PFALSEPNLCLIP50**

- Use to secure false front on sink base.
- Sold in pairs.



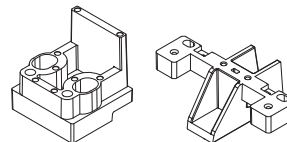

**ROLL TRAY PLUG IN  
BRACKET**











**RTBKXSXP**

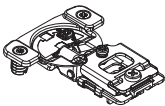

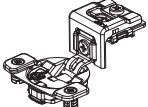

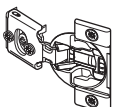
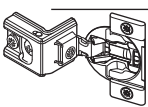
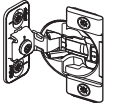
- For use with roll tray hardware to prevent interference with door hinges. Also included in roll tray hardware kit.
- Includes four end panel brackets, two vertical stile brackets, and screws.

DESCRIPTION	MODEL
-------------	-------

STAIN, PAINT, & TOUCH-UP TOOLS	
STAIN & PAINT	  <b>QUARTCOLOR</b> <b>SSC</b> <b>SSCCLEAR</b>  <b>SSCMATTESH</b>
	<ul style="list-style-type: none"> <li>• Wiping stains can be sprayed at low pressure.</li> <li>• Specify finish name and wood type when ordering.</li> <li>• QUARTCOLOR sold in quarts.</li> <li>• SSC is a 384 mL aerosol can available in Paint colors.</li> <li>• SSCCLEAR is a 384 mL aerosol can in clear.</li> <li>• SSCMATTESH is a 384 mL aerosol can in clear with a matte sheen.</li> <li>• Not available in Arctic, Antler, Elk, High Gloss White, Obsidian, or Wharf.</li> <li>• For Touch-up Kits and Glaze Pens, see below.</li> </ul>
	TOUCH-UP TOOLS
	 <b>TUK</b> <b>MTUK</b> <b>GLAZEPEN</b>
	<ul style="list-style-type: none"> <li>• Touch-up Kit includes touch-up marker and a fill stick.</li> <li>• MTUK ordered in Paints with glaze will only contain the base color.</li> <li>• Mini Touch-up Kit includes small touch-up marker and a small fill stick.</li> <li>• GLAZEPEN available in glaze colors only.</li> <li>• GLAZEPEN works on finished doors and does not require a separate top coat.</li> </ul>

DESCRIPTION	MODEL
-------------	-------

HINGES	
   <b>HINGEQRPO</b>	<b>Quick-Release™ with Integrated Smart Stop, 6-way Adjustable, Partial Overlay, 107° Hinge</b> All cabinets not specified by other hinges. For use on full overlay styles: Diagonal Wall (DW) and Base (DAB) Cabinets, Angled Corner Sink Bases (ACS) & Fronts (ACSF), Wall Top Hinge (WTH) Cabinets with Modified Full Overlay (MFO).
  <b>HINGEQRFO</b>	<b>Quick-Release™ with Integrated Smart Stop, 6-way Adjustable, Full Overlay, 107° Hinge</b> All cabinets not specified by other hinges.
 <b>38NPOHINGE</b>	<b>Integrated Smart Stop, 6-way Adjustable, 1/2" Partial Overlay, 107° Hinge</b> For use on Base Message Center (BMC) and on full overlay styles: Base Transition Cabinets (BTC), Wall Transition Cabinets (WTC), and Stacked Wall Transition Cabinets (STWTC).
 <b>38CFOHINGE</b>	<b>Integrated Smart Stop, 6-way Adjustable, Full Overlay, 107° Hinge</b> For use on Base Message Center (BMC)
 <b>38BFOVHINGE</b>	<b>Integrated Soft-close, 4-way Adjustable, Full Overlay, Face-mount 107° Hinge</b> OCD, OMC, OCS, and TBMWb cabinets 36" and 42" high WBMW, full and partial overlay
 <b>32049HINGE</b>	<b>90° Corner Self-Closing Center Hinge</b> Center Hinge for ER, BLS, SLS, BER, BERAS, and CS
 <b>942HINGE</b>	<b>170° Hinge</b> BSC, BLS, SLS, BER, BERAS, CS, and ER
 <b>7299HINGE</b>	<b>Mirror Hinge</b> TV and MC cabinets
	<ul style="list-style-type: none"> <li>• Sold in pairs.</li> </ul>

HINGE ANGLE RESTRICTION CLIPS	  <b>RESCLIPQR</b> <b>HINGERESCLIP</b>
 <b>RESCLIPQR</b>	<ul style="list-style-type: none"> <li>• For use in applications with cabinets installed at varying depths to prevent the door damage caused by opening into an adjacent cabinet.</li> <li>• Restricts hinges to 86° opening capability.</li> <li>• RESCLIPQR works only with the HINGEQRPO and HINGEQRFO.</li> <li>• HINGERESCLIP works only with the 38NPOHINGE and 38CFOHINGE.</li> <li>• Not recommended for cabinets with roll trays specified in partial overlay styles.</li> <li>• Sold in pairs.</li> </ul>
 <b>HINGERESCLIP</b>	



**DESCRIPTION**

**HINGE SHIM**



**MODEL**

**HINGESHIMS**

- Install between the face frame and hinge to allow additional adjustment of doors. Can be used to reduce gap between butt doors.
- Pack of 5 metal shims.
- Compatible with all hinges except face-mount.

**LIDSTAY**

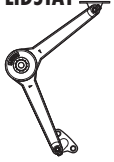

**LIDSTAY**

- Sold in pairs.
- Recommended for field installed wall top hinge applications up to 18" high.

**LIDSTAY - HEAVY DUTY**

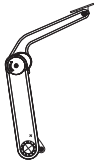

**LIDSTAYHD**

- One heavy duty lid stay hinge required per cabinet.
- Recommended for field installed wall top hinge applications of 21" high cabinets.

**PARTS**

**DOORS & DRAWER FRONTS**



Standard Door Size, 18" High or Less

Standard Door Size, 21" to 30" High

Standard Door Size, 33" or Higher

Standard Door Size, No Hinge Route, 18" High or Less

Standard Door Size, No Hinge Route, 21" to 30" High

Standard Door Size, No Hinge Route, 33" or Higher

Any Drawer Front

- Door heights are based on full overlay for equivalent applications.
- Backs of "NO HINGE ROUTE" doors may have identification marks, be unfinished, and have 3/16" diameter holes used during finish processing. For these reasons, these doors are not suitable for use as cabinet doors.

**DRAWERS**



Complete Drawer

Drawer Box Only

- Complete Drawer and Drawer Box Only do not include drawer guides. They must be ordered separately.

**Species Availability (Wood)**

Alder	Rustic Alder	Cherry	Hickory	Maple	Oak
•	•	•	•	•	•

**Species Availability (All Laminates)**

High Gloss	Horiz. Grain on Maple	Vert. Grain on Maple	Vert. Grain on Cherry	Vert. Grain on Hickory	Vert. Grain on Oak	Thermofoil
•	•	•	•	•	•	•

**DESCRIPTION**

**MISCELLANEOUS PARTS**



**MODEL**

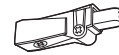

**PDM**

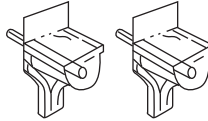

**SHELFPEGS**

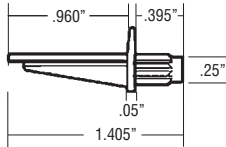

**SHELFPEGSCTR**

**BRKOFFSCREW** (pkg. 25)

**INSTALLSCR24** (pkg. 24)

**INSTALLSCREWS** (pkg. 100)

**TVHDW/WCATCH**

**MC16HDW/WCATCH**

**RETCLIP25OBAG**

**BUMPERPADS** (pkg. 25)

**PDM**

**SHELFPEGS** (pkg. 24)

**SHELFPEGSCTR** (pkg. 6)

- BRKOFFSCREW is a pack of 25 breakaway screws for use with decorative hardware pulls and knobs.
- INSTALLSCR24 and INSTALLSCREWS are screws for cabinet installation through the cabinet back to the wall studs (includes a pack of 24 or 100).
- TVHDW/WCATCH is one set of the magnetic catch hardware and handle used on mirrors on Tri-View Mirrors (TV.).
- MC16HDW/WCATCH is one set of the magnetic catch hardware, handle, and one pair of hinges used on Single Door Medicine Cabinets (MC16).
- RETCLIP25OBAG: 6 retainer clips for use with glass inserts in mullion and cut-for-glass doors.
- PDM creates a smooth and silent self-closing motion and includes all installation hardware.
- SHELFPEGS are 3mm steel pins with clear plastic shoulders.
- SHELFPEGSCTR is a package of 6 clear plastic shelf clips with 0.96" usable depth with 1/4" diameter pegs used on center mullions of full depth shelves.



**DESCRIPTION**

**MODEL**

**STACK MOULDING KITS**

- Moulding stacks do not ship assembled; field assembly is required. Assembly instructions can be viewed in 20/20 spec pages and will also ship with moulding kits.
- When ordered as a kit, only one finish can be specified. To order with more than one finish, moulding pieces must be ordered separately.
- Moulding stacks include Assembly Instructions. Cleats and finish nails not included.

- How to place a stack moulding in 20/20:
  - Moulding
  - Top Mouldings or Bottom Mouldings
  - Stacked Mouldings
  - Drag and drop desired moulding stack onto wall cabinets
- Mouldings specified as 8" nominal length have a usable length range of 93" up to 99". Mouldings specified as 10" nominal length have a usable length range of 117" up to 123". Be sure to order the correct amount of moulding length to work around required cuts with minimal butt joints.

**MOULDING STACK 1**

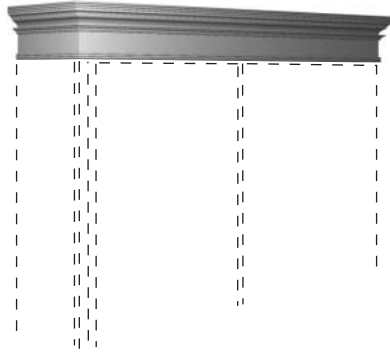

\*Cleats and finish nails not included.

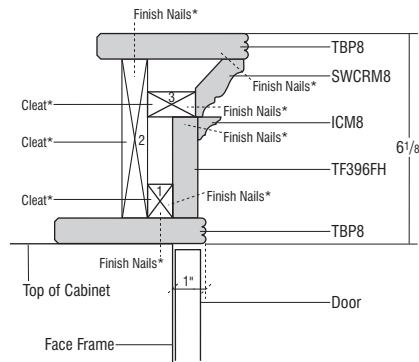

**STKMLD1**

**Finish Techniques**

	Distressing	Heirlooming
TBP8		•
SWCRM8	•	•
ICM8		
TF396FH	•	

**Species Availability (Wood)**

	Alder	Rustic Alder	Cherry	Hickory	Maple	Oak
TBP8	•	Alder	•	•	•	•
SWCRM8	•	•	•	•	•	•
ICM8	•	Alder	•	•	•	•
TF396FH	•	Alder	•	•	•	•

**Species Availability (All Laminates)**

	High Gloss	Horiz. Grain on Maple	Vert. Grain on Maple	Vert. Grain on Cherry	Vert. Grain on Hickory	Vert. Grain on Oak	Thermofoil
TBP8	box color	box color	box color	box color	box color	box color	box color
SWCRM8	box color	box color	box color	box color	box color	box color	box color
ICM8	box color	box color	box color	box color	box color	box color	box color
TF396FH	box color	box color	box color	box color	box color	box color	box color

**MOULDING STACK 2**

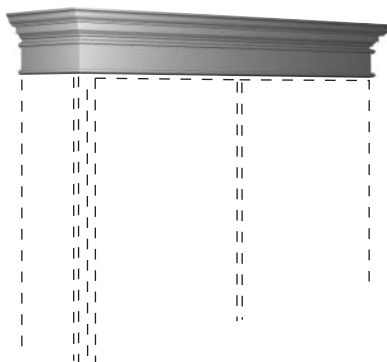

\*Cleats and finish nails not included.

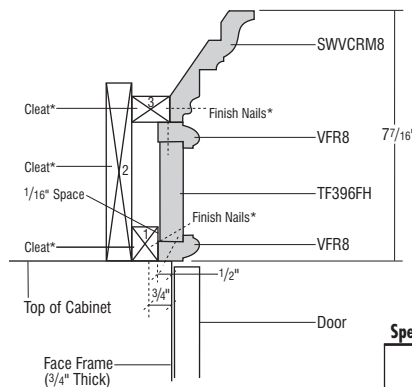

**STKMLD2**

**Finish Techniques**

	Distressing	Heirlooming
SWVCRM8	•	•
VFR8		•
TF396FH	•	

**Species Availability (Wood)**

	Alder	Rustic Alder	Cherry	Hickory	Maple	Oak
SWVCRM8	•	•	•	•	•	•
VFR8	•	Alder	•	•	•	•
TF396FH	•	Alder	•	•	•	•

**Species Availability (All Laminates)**

	High Gloss	Horiz. Grain on Maple	Vert. Grain on Maple	Vert. Grain on Cherry	Vert. Grain on Hickory	Vert. Grain on Oak	Thermofoil
SWVCRM8	box color	box color	box color	box color	box color	box color	box color
VFR8	box color	box color	box color	box color	box color	box color	box color
TF396FH	box color	box color	box color	box color	box color	box color	box color

**DESCRIPTION**

**MODEL**

**MOULDING STACK 3**

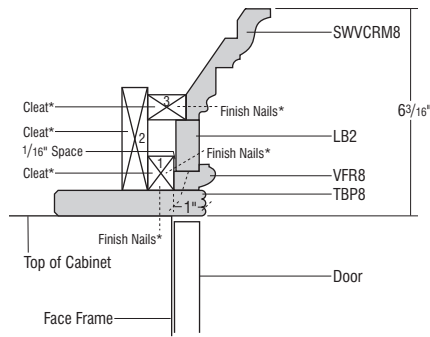
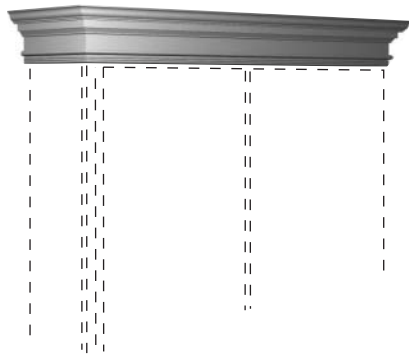

\*Cleats and finish nails not included.



**STKMLD3**

- Not recommended for use when taking application to the ceiling.

**Finish Techniques**

	Distressing	Heirlooming
SWVCRM8	•	•
LB2		
VFR8		•
TBP8		•

**Species Availability (Wood)**

	Alder	Rustic Alder	Cherry	Hickory	Maple	Oak
SWVCRM8	•	•	•	•	•	•
LB2	•	Alder	•	•	•	•
VFR8	•	Alder	•	•	•	•
TBP8	•	Alder	•	•	•	•

**Species Availability (All Laminates)**

	High Gloss	Horiz. Grain on Maple	Vert. Grain on Maple	Vert. Grain on Cherry	Vert. Grain on Hickory	Vert. Grain on Oak	Thermofoil
SWVCRM8	box color	box color	box color	box color	box color	box color	box color
LB2	box color	box color	box color	box color	box color	box color	box color
VFR8	box color	box color	box color	box color	box color	box color	box color
TBP8	box color	box color	box color	box color	box color	box color	box color

**MOULDING STACK 5**

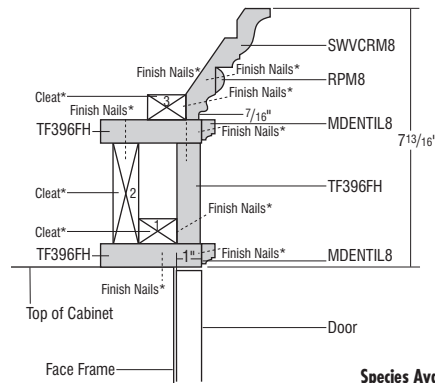
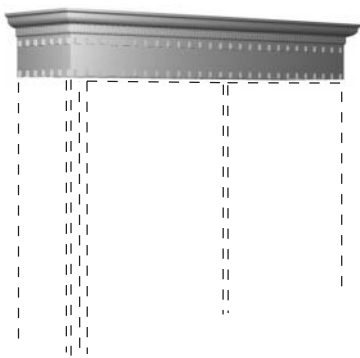

\*Cleats and finish nails not included.



**STKMLD5**

**Finish Techniques**

	Distressing	Heirlooming
SWVCRM8	•	•
RPM8		
MDENTIL8		
TF396FH	•	

**Species Availability (Wood)**

	Alder	Rustic Alder	Cherry	Hickory	Maple	Oak
SWVCRM8	•	•	•	•	•	•
RPM8	•	Alder	•	•	•	•
MDENTIL8	•	Alder	•	•	•	•
TF396FH	•	Alder	•	•	•	•

**Species Availability (All Laminates)**

	High Gloss	Horiz. Grain on Maple	Vert. Grain on Maple	Vert. Grain on Cherry	Vert. Grain on Hickory	Vert. Grain on Oak	Thermofoil
SWVCRM8	box color	box color	box color	box color	box color	box color	box color
RPM8	box color	box color	box color	box color	box color	box color	box color
MDENTIL8	box color	box color	box color	box color	box color	box color	box color
TF396FH	box color	box color	box color	box color	box color	box color	box color

**MOULDING STACK 6**

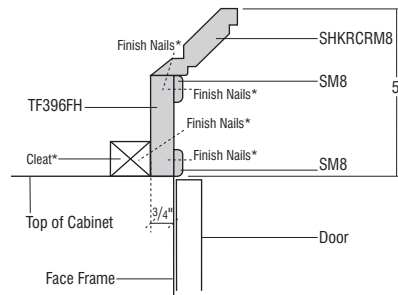
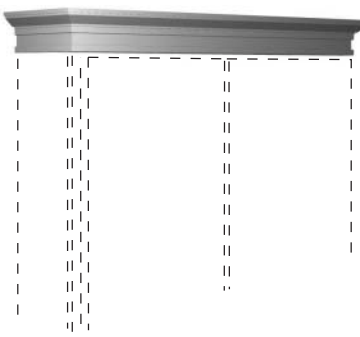

\*Cleats and finish nails not included.



**STKMLD6**

- Not recommended for use when taking application to the ceiling.

**Finish Techniques**

	Distressing	Heirlooming
SHKRCRM8	•	•
SM8		
TF396FH	•	

**Species Availability (Wood)**

	Alder	Rustic Alder	Cherry	Hickory	Maple	Oak
SHKRCRM8	•	•	•	•	•	•
SM8	•	Alder	•	•	•	•
TF396FH	•	Alder	•	•	•	•

**Species Availability (All Laminates)**

	High Gloss	Horiz. Grain on Maple	Vert. Grain on Maple	Vert. Grain on Cherry	Vert. Grain on Hickory	Vert. Grain on Oak	Thermofoil
SHKRCRM8	box color	box color	box color	box color	box color	box color	box color
SM8	box color	box color	box color	box color	box color	box color	box color
TF396FH	box color	box color	box color	box color	box color	box color	box color

**DESCRIPTION**

**MOULDING STACK 7**

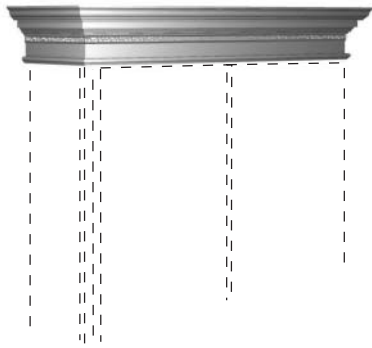

\*Cleats and finish nails not included.

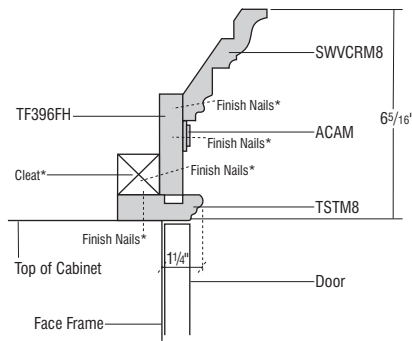

**MODEL**



**STKMLD7**

- Not recommended for use when taking application to the ceiling.

**Finish Techniques**

	Distressing	Heirlooming
SWVCRM8	•	•
ACAM		
TF396FH	•	
TSTM8		

**Species Availability (Wood)**

	Alder	Rustic Alder	Cherry	Hickory	Maple	Oak
SWVCRM8	•	•	•	•	•	•
ACAM	•	Alder	•	Beech	•	Beech
TF396FH	•	Alder	•	•	•	•
TSTM8	•	Alder	•	•	•	•

**Species Availability (All Laminates)**

	High Gloss	Horiz. Grain on Maple	Vert. Grain on Maple	Vert. Grain on Cherry	Vert. Grain on Hickory	Vert. Grain on Oak	Thermofoil
SWVCRM8	box color	box color	box color	box color	box color	box color	box color
ACAM	box color	box color	box color	box color	Beech	Beech	box color
TF396FH	box color	box color	box color	box color	box color	box color	box color
TSTM8	box color	box color	box color	box color	box color	box color	box color

**MOULDING STACK 8**

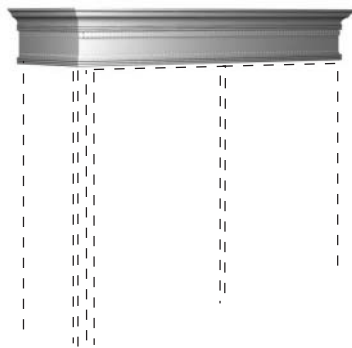

\*Cleats and finish nails not included.

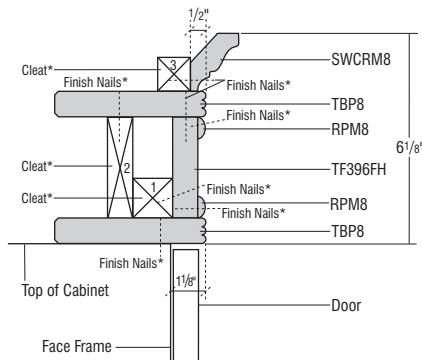

**STKMLD8**

- Not recommended for use when taking application to the ceiling.

**Finish Techniques**

	Distressing	Heirlooming
SWCRM8	•	•
RPM8		
TBP8		•
TF396FH	•	

**Species Availability (Wood)**

	Alder	Rustic Alder	Cherry	Hickory	Maple	Oak
SWCRM8	•	•	•	•	•	•
RPM8	•	Alder	•	•	•	•
TBP8	•	Alder	•	•	•	•
TF396FH	•	Alder	•	•	•	•

**Species Availability (All Laminates)**

	High Gloss	Horiz. Grain on Maple	Vert. Grain on Maple	Vert. Grain on Cherry	Vert. Grain on Hickory	Vert. Grain on Oak	Thermofoil
SWCRM8	box color	box color	box color	box color	box color	box color	box color
RPM8	box color	box color	box color	box color	box color	box color	box color
TBP8	box color	box color	box color	box color	box color	box color	box color
TF396FH	box color	box color	box color	box color	box color	box color	box color

**MOULDING STACK 10**

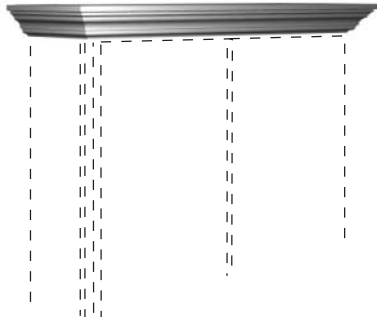

\*Cleats and finish nails not included.

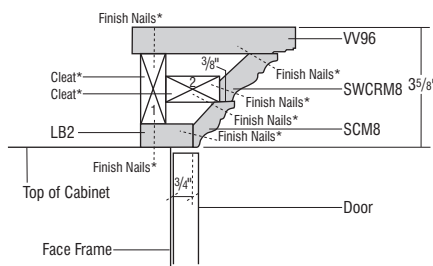

**STKMLD10**

- Not recommended for use when taking application to the ceiling.

**Finish Techniques**

	Distressing	Heirlooming
VV96	•	•
SWCRM8	•	•
SCM8	•	•
LB2		

**Species Availability (Wood)**

	Alder	Rustic Alder	Cherry	Hickory	Maple	Oak
VV96	•	•	•	•	•	•
SWCRM8	•	•	•	•	•	•
SCM8	•	•	•	•	•	•
LB2	•	Alder	•	•	•	•

**Species Availability (All Laminates)**

	High Gloss	Horiz. Grain on Maple	Vert. Grain on Maple	Vert. Grain on Cherry	Vert. Grain on Hickory	Vert. Grain on Oak	Thermofoil
VV96	box color	box color	box color	box color	box color	box color	box color
SWCRM8	box color	box color	box color	box color	box color	box color	box color
SCM8	box color	box color	box color	box color	box color	box color	box color
LB2	box color	box color	box color	box color	box color	box color	box color

**DESCRIPTION**

**MODEL**

434

**MOULDING STACK 11**

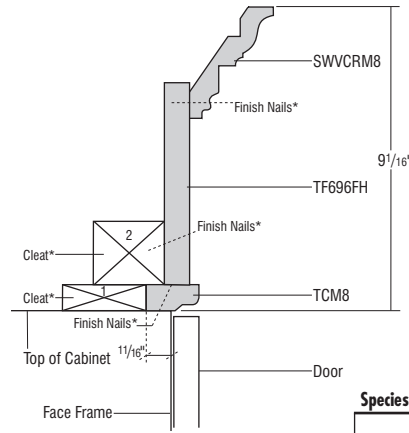
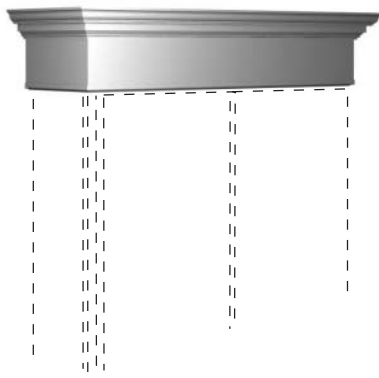

\*Cleats and finish nails not included.



**STKMLD11**

**Finish Techniques**

	Distressing	Heirlooming
SWVCRM8	•	•
TF696FH	•	
TCM8		•

**Species Availability (Wood)**

	Alder	Rustic Alder	Cherry	Hickory	Maple	Oak
SWVCRM8	•	•	•	•	•	•
TF696FH	•	Alder	•	•	•	•
TCM8	•	Alder	•	•	•	•

**Species Availability (All Laminates)**

	High Gloss	Horiz. Grain on Maple	Vert. Grain on Maple	Vert. Grain on Cherry	Vert. Grain on Hickory	Vert. Grain on Oak	Thermofoil
SWVCRM8	box color	box color	box color	box color	box color	box color	box color
TF696FH	box color	box color	box color	box color	box color	box color	box color
TCM8	box color	box color	box color	box color	box color	box color	box color

**MOULDING STACK 13**

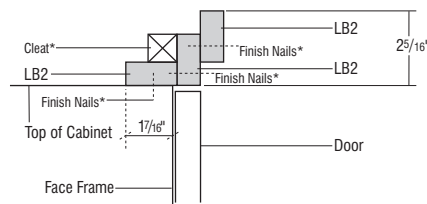
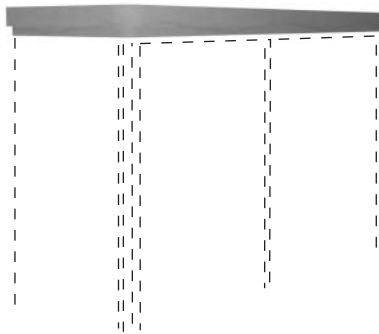

\*Cleats and finish nails not included.



**STKMLD13**

**Finish Techniques**

	Distressing	Heirlooming
LB2		

**Species Availability (Wood)**

	Alder	Rustic Alder	Cherry	Hickory	Maple	Oak
LB2	•	Alder	•	•	•	•

**Species Availability (All Laminates)**

	High Gloss	Horiz. Grain on Maple	Vert. Grain on Maple	Vert. Grain on Cherry	Vert. Grain on Hickory	Vert. Grain on Oak	Thermofoil
LB2	box color	box color	box color	box color	box color	box color	box color

**MOULDING STACK 14**

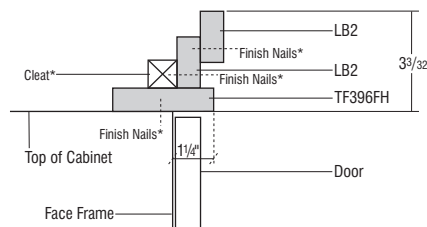
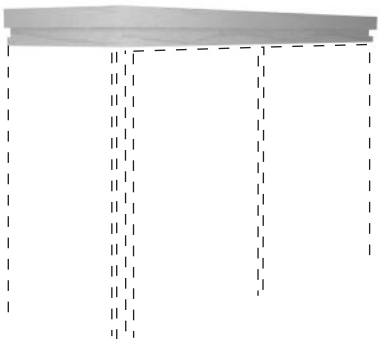

\*Cleats and finish nails not included.



**STKMLD14**

**Finish Techniques**

	Distressing	Heirlooming
LB2		
TF396FH	•	

**Species Availability (Wood)**

	Alder	Rustic Alder	Cherry	Hickory	Maple	Oak
LB2	•	Alder	•	•	•	•
TF396FH	•	Alder	•	•	•	•

**Species Availability (All Laminates)**

	High Gloss	Horiz. Grain on Maple	Vert. Grain on Maple	Vert. Grain on Cherry	Vert. Grain on Hickory	Vert. Grain on Oak	Thermofoil
LB2	box color	box color	box color	box color	box color	box color	box color
TF396FH	box color	box color	box color	box color	box color	box color	box color

**DESCRIPTION**

**MODEL**

**MOULDING STACK 16**

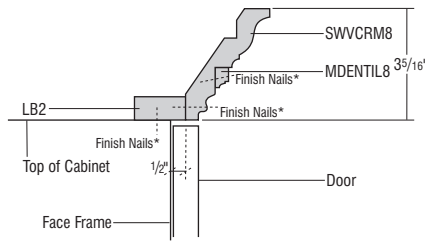
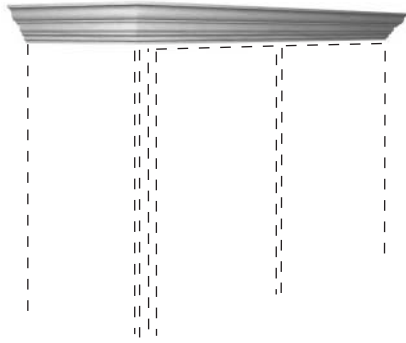

\*Cleats and finish nails not included.



**STKMLD16**

- Not recommended for use when taking application to the ceiling.

**Finish Techniques**

	Distressing	Heirlooming
SWVCRM8	•	•
MDENTIL8		
LB2		

**Species Availability (Wood)**

	Alder	Rustic Alder	Cherry	Hickory	Maple	Oak
SWVCRM8	•	•	•	•	•	•
MDENTIL8	•	Alder	•		•	•
LB2	•	Alder	•	•	•	•

**Species Availability (All Laminates)**

	High Gloss	Horiz. Grain on Maple	Vert. Grain on Maple	Vert. Grain on Cherry	Vert. Grain on Hickory	Vert. Grain on Oak	Thermofoil
SWVCRM8	box color	box color	box color	box color	box color	box color	box color
MDENTIL8	box color	box color	box color	box color	box color	box color	box color
LB2	box color	box color	box color	box color	box color	box color	box color

**435**

**MOULDING STACK 17**

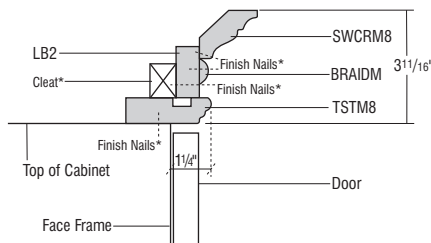
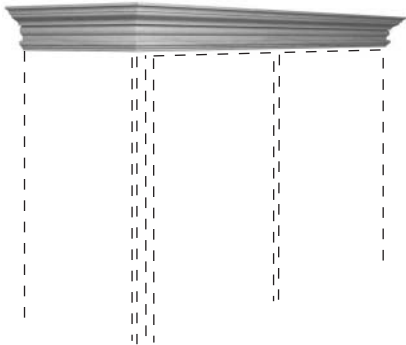

\*Cleats and finish nails not included.



**STKMLD17**

- Not recommended for use when taking application to the ceiling.

**Finish Techniques**

	Distressing	Heirlooming
SWCRM8	•	•
LB2		
BRAIDM		
TSTM8		

**Species Availability (Wood)**

	Alder	Rustic Alder	Cherry	Hickory	Maple	Oak
SWCRM8	•	•	•	•	•	•
LB2	•	Alder	•	•	•	•
BRAIDM	•	Alder	•	Beech	•	Beech
TSTM8	•	Alder	•	•	•	•

**Species Availability (All Laminates)**

	High Gloss	Horiz. Grain on Maple	Vert. Grain on Maple	Vert. Grain on Cherry	Vert. Grain on Hickory	Vert. Grain on Oak	Thermofoil
SWCRM8	box color	box color	box color	box color	box color	box color	box color
LB2	box color	box color	box color	box color	box color	box color	box color
BRAIDM	box color	box color	box color	box color	Beech	Beech	box color
TSTM8	box color	box color	box color	box color	box color	box color	box color

**MOULDING STACK 18**

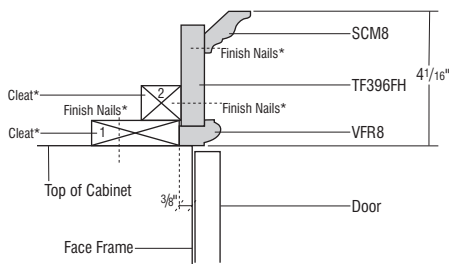
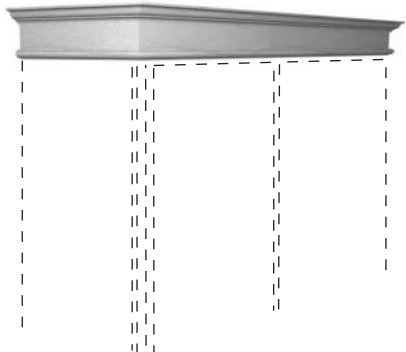

\*Cleats and finish nails not included.



**STKMLD18**

**Finish Techniques**

	Distressing	Heirlooming
SCM8	•	•
TF396FH	•	
VFR8		•

**Species Availability (Wood)**

	Alder	Rustic Alder	Cherry	Hickory	Maple	Oak
SCM8	•	•	•	•	•	•
TF396FH	•	Alder	•	•	•	•
VFR8	•	Alder	•	•	•	•

**Species Availability (All Laminates)**

	High Gloss	Horiz. Grain on Maple	Vert. Grain on Maple	Vert. Grain on Cherry	Vert. Grain on Hickory	Vert. Grain on Oak	Thermofoil
SCM8	box color	box color	box color	box color	box color	box color	box color
TF396FH	box color	box color	box color	box color	box color	box color	box color
VFR8	box color	box color	box color	box color	box color	box color	box color

DESCRIPTION

MODEL

MOULDING STACK 19



STKMLD19

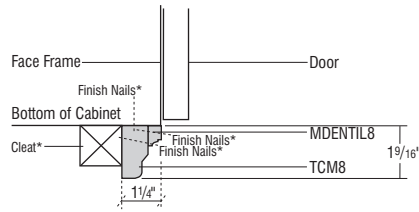
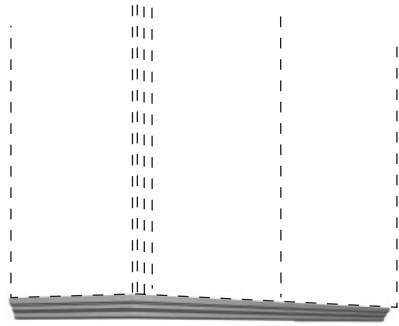

Finish Techniques

	Distressing	Heirlooming
MDENTIL8		
TCM8		•

Species Availability (Wood)

	Alder	Rustic Alder	Cherry	Hickory	Maple	Oak
MDENTIL8	•	Alder	•		•	•
TCM8	•	Alder	•	•	•	•

Species Availability (All Laminates)

	High Gloss	Horiz. Grain on Maple	Vert. Grain on Maple	Vert. Grain on Cherry	Vert. Grain on Hickory	Vert. Grain on Oak	Thermofoil
MDENTIL8	box color	box color	box color	box color		box color	box color
TCM8	box color	box color	box color	box color	box color	box color	box color

\*Cleats and finish nails not included.

MOULDING STACK 20



STKMLD20

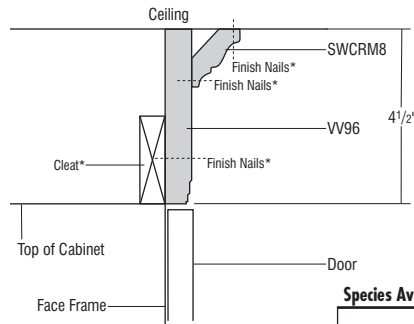
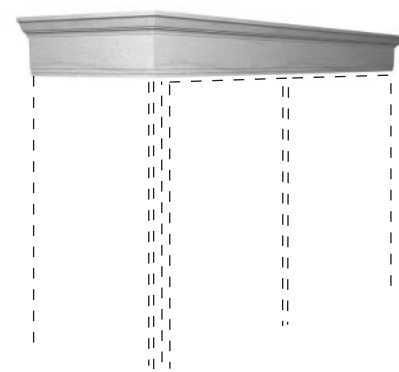

Finish Techniques

	Distressing	Heirlooming
SWCRM8	•	•
VV96	•	•

Species Availability (Wood)

	Alder	Rustic Alder	Cherry	Hickory	Maple	Oak
SWCRM8	•	•	•	•	•	•
VV96	•	•	•	•	•	•

Species Availability (All Laminates)

	High Gloss	Horiz. Grain on Maple	Vert. Grain on Maple	Vert. Grain on Cherry	Vert. Grain on Hickory	Vert. Grain on Oak	Thermofoil
SWCRM8	box color	box color	box color	box color	box color	box color	box color
VV96	box color	box color	box color	box color	box color	box color	box color

\*Cleats and finish nails not included.

MOULDING STACK 21



STKMLD21

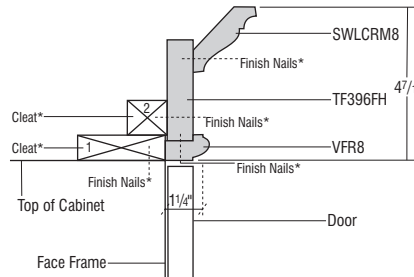
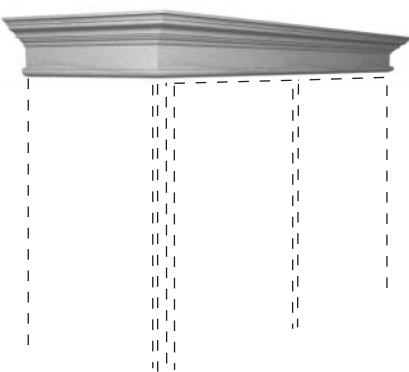

Finish Techniques

	Distressing	Heirlooming
SWLCRM8	•	•
TF396FH	•	
VFR8		•

Species Availability (Wood)

	Alder	Rustic Alder	Cherry	Hickory	Maple	Oak
SWLCRM8	•	•	•	•	•	•
TF396FH	•	Alder	•	•	•	•
VFR8	•	Alder	•	•	•	•

Species Availability (All Laminates)

	High Gloss	Horiz. Grain on Maple	Vert. Grain on Maple	Vert. Grain on Cherry	Vert. Grain on Hickory	Vert. Grain on Oak	Thermofoil
SWLCRM8	box color	box color	box color	box color	box color	box color	box color
TF396FH	box color	box color	box color	box color	box color	box color	box color
VFR8	box color	box color	box color	box color	box color	box color	box color

\*Cleats and finish nails not included.

**DESCRIPTION**

**MODEL**

**MOULDING STACK 22**



**STKMLD22**

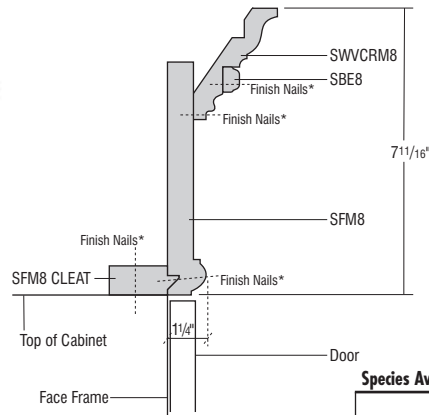
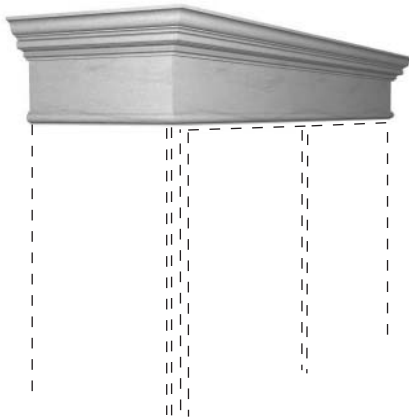

\*Cleats and finish nails not included.

**Finish Techniques**

	Distressing	Heirlooming
SWVCRM8	•	•
SBE8		•
SFM8		•

**Species Availability (Wood)**

	Alder	Rustic Alder	Cherry	Hickory	Maple	Oak
SWVCRM8	•	•	•	•	•	•
SBE8	•	Alder	•	•	•	•
SFM8	•	•	•	•	•	•

**Species Availability (All Laminates)**

	High Gloss	Horiz. Grain on Maple	Vert. Grain on Maple	Vert. Grain on Cherry	Vert. Grain on Hickory	Vert. Grain on Oak	Thermofoil
SWVCRM8	box color	box color	box color	box color	box color	box color	box color
SBE8	box color	box color	box color	box color	box color	box color	box color
SFM8	box color	box color	box color	box color	box color	box color	box color

**MOULDING STACK 23**



**STKMLD23**

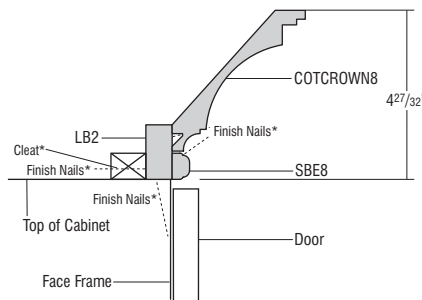
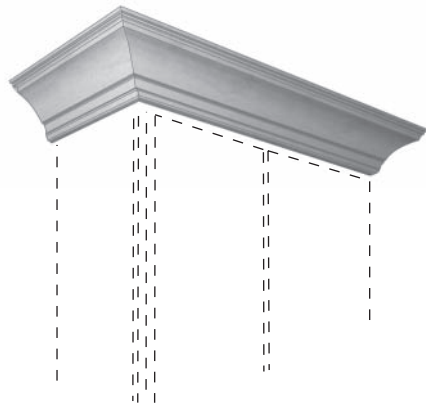

\*Cleats and finish nails not included.

- Not recommended for use when taking application to the ceiling.

**Finish Techniques**

	Distressing	Heirlooming
COTCROWN8	•	•
LB2		
SBE8		•

**Species Availability (Wood)**

	Alder	Rustic Alder	Cherry	Hickory	Maple	Oak
COTCROWN8	•	•	•	•	•	•
LB2	•	Alder	•	•	•	•
SBE8	•	Alder	•	•	•	•

**Species Availability (All Laminates)**

	High Gloss	Horiz. Grain on Maple	Vert. Grain on Maple	Vert. Grain on Cherry	Vert. Grain on Hickory	Vert. Grain on Oak	Thermofoil
COTCROWN8	box color	box color	box color	box color	box color	box color	box color
LB2	box color	box color	box color	box color	box color	box color	box color
SBE8	box color	box color	box color	box color	box color	box color	box color

**MOULDING STACK 24**



**STKMLD24**

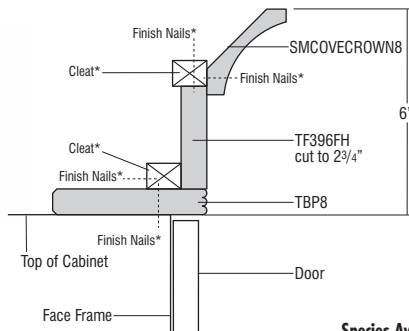

\*Cleats and finish nails not included.

**Finish Techniques**

	Distressing	Heirlooming
SMCOVECROWN8	•	•
TF396FH	•	
TBP8		•

**Species Availability (Wood)**

	Alder	Rustic Alder	Cherry	Hickory	Maple	Oak
SMCOVECROWN8	•	•	•	•	•	•
TF396FH	•	Alder	•	•	•	•
TBP8	•	Alder	•	•	•	•

**Species Availability (All Laminates)**

	High Gloss	Horiz. Grain on Maple	Vert. Grain on Maple	Vert. Grain on Cherry	Vert. Grain on Hickory	Vert. Grain on Oak	Thermofoil
SMCOVECROWN8	box color	box color	box color	box color	box color	box color	box color
TF396FH	box color	box color	box color	box color	box color	box color	box color
TBP8	box color	box color	box color	box color	box color	box color	box color

DESCRIPTION

MODEL

MOULDING STACK 25

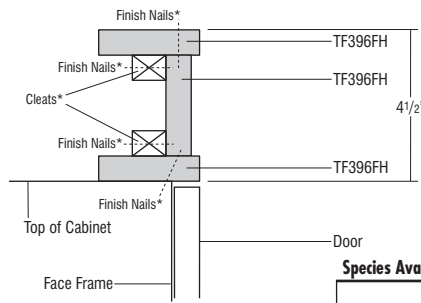
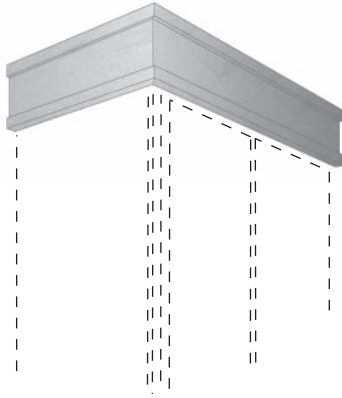

STKMULD25

Finish Techniques

	Distressing	Heirlooming
TF396FH	•	

Species Availability (Wood)

	Alder	Rustic Alder	Cherry	Hickory	Maple	Oak
TF396FH	•	Alder	•	•	•	•

Species Availability (All Laminates)

	High Gloss	Horiz. Grain on Maple	Vert. Grain on Maple	Vert. Grain on Cherry	Vert. Grain on Hickory	Vert. Grain on Oak	Thermofoil
TF396FH	box color	box color	box color	box color	box color	box color	box color

\*Cleats and finish nails not included.

MOULDING STACK 26

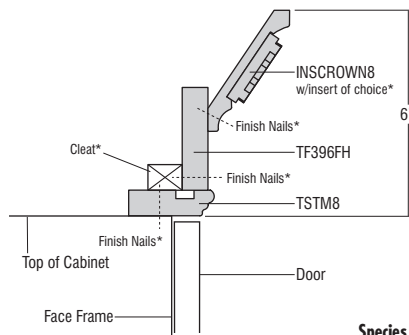

STKMULD26

Finish Techniques

	Distressing	Heirlooming
INSCROWN8		•
TF396FH	•	
TSTM8		

Species Availability (Wood)

	Alder	Rustic Alder	Cherry	Hickory	Maple	Oak
INSCROWN8	•	Alder	•		•	•
TF396FH	•	Alder	•	•	•	•
TSTM8	•	Alder	•	•	•	•

Species Availability (All Laminates)

	High Gloss	Horiz. Grain on Maple	Vert. Grain on Maple	Vert. Grain on Cherry	Vert. Grain on Hickory	Vert. Grain on Oak	Thermofoil
INSCROWN8	box color	box color	box color	box color	box color	box color	box color
TF396FH	box color	box color	box color	box color	box color	box color	box color
TSTM8	box color	box color	box color	box color	box color	box color	box color

\*Cleats and finish nails not included.

MOULDING STACK 27

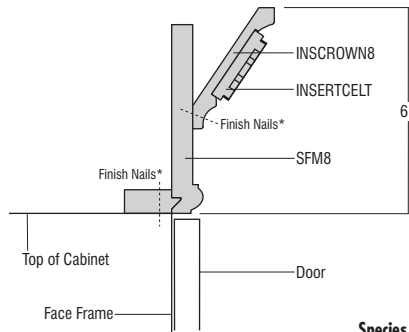
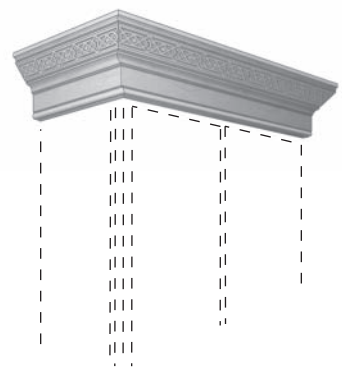

STKMULD27

Finish Techniques

	Distressing	Heirlooming
INSCROWN8		•
INSERTCELT		•
SFM8		•

Species Availability (Wood)

	Alder	Rustic Alder	Cherry	Hickory	Maple	Oak
INSCROWN8	•	Alder	•		•	•
INSERTCELT			•		•	
SFM8	•	•	•	•	•	•

Species Availability (All Laminates)

	High Gloss	Horiz. Grain on Maple	Vert. Grain on Maple	Vert. Grain on Cherry	Vert. Grain on Hickory	Vert. Grain on Oak	Thermofoil
INSCROWN8	box color	box color	box color	box color		box color	box color
INSERTCELT	box color	box color	box color	box color		box color	box color
SFM8	box color	box color	box color	box color	box color	box color	box color

\*Cleats and finish nails not included.



**DESCRIPTION**

**MOULDING STACK 28**

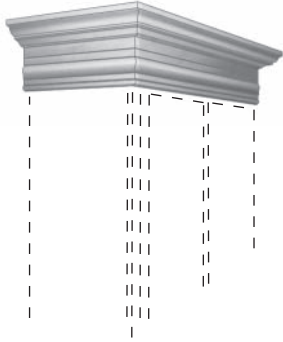

\*Cleats and finish nails not included.

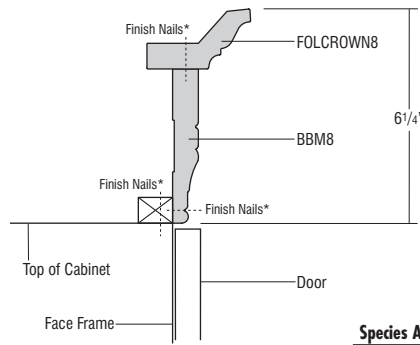

**MODEL**



**STKMLD28**

- Not recommended for use when taking application to the ceiling.

**Finish Techniques**

	Distressing	Heirlooming
FOLCROWN8		•
BBM8	•	•

**Species Availability (Wood)**

	Alder	Rustic Alder	Cherry	Hickory	Maple	Oak
FOLCROWN8	•	•	•	•	•	•
BBM8	•	•	•	•	•	•

**Species Availability (All Laminates)**

	High Gloss	Horiz. Grain on Maple	Vert. Grain on Maple	Vert. Grain on Cherry	Vert. Grain on Hickory	Vert. Grain on Oak	Thermofoil
FOLCROWN8	box color	box color	box color	box color	box color	box color	box color
BBM8	box color	box color	box color	box color	box color	box color	box color

**439**

# Diamond<sup>®</sup>

DISTINCTION™ SERIES

Dear Diamond Customer,

Congratulations on your selection of Diamond cabinetry with an Heirlooming finish. Because of its unique characteristics, this finish is quite different from other cabinetry finishes you may be familiar with. Your satisfaction is important to Diamond, and we want you to fully understand the characteristics that make an Heirlooming Finish unique.

Our heirlooming technique is available on the following finishes: Black, Juniper Berry, Juniper Berry w/Tidal Mist, Maritime, Moonstone, Seaside, Seaside w/Oasis, and Storm. The finish will be sanded through the base coat to expose the surface of the wood. This type of sand through on the edges and profiles creates a naturally worn appearance. If a finish is chosen with a glaze, the glaze will be applied after sanding has been done. This will enhance those areas of exposed wood to take on the darker characteristics of the applied glaze.

Normal Characteristics of Painted, Sand-Through Finishes include:

- Hairline Cracking
- Visible textures of natural grain patterns
- Variation in rub through and wear techniques

Accordingly, we ask that the following agreement be signed for Heirlooming Finish orders.

\_\_\_\_\_

I have read the foregoing and find the characteristic variations of wood with Heirlooming finish are desirable. As such, I agree not to hold Diamond and/or the Diamond dealer listed below responsible in the event that these characteristics are later found by me to be less desirable than I had expected.

\_\_\_\_\_

Customer Signature

\_\_\_\_\_

Dealer Signature

\_\_\_\_\_

Customer Name (please print)

\_\_\_\_\_

Dealer Name (please print)

\_\_\_\_\_

Dealer Purchase Order Number

**Diamond**<sup>®</sup>  
DISTINCTION™ SERIES

Dear Diamond Customer,

Congratulations on your selection of Diamond cabinetry in a Paint or Paint with Glaze finish. Because of its unique characteristics, this finish is quite different from other cabinetry finishes you may be familiar with. Your satisfaction is important to Diamond, and we want you to fully understand the characteristics that make painted finishes so distinctive.

It is important to realize that the beauty of wood cabinetry comes from the natural qualities of wood itself. Diamond utilizes only select solid hardwoods and veneers. The beauty of these genuine woods lies in the variation of the grain. The textures of those natural grain patterns often remain visible with paint finish and should be accepted as inherent characteristics when selecting painted cabinetry. When ordering painted Maple 5-piece styles (except Liberty), the door's center panel will be constructed of MDF material.

On both Maple and MDF, seam lines and hairline cracking at stile, rail and panel joints are normal characteristics of painted finishes and should not be considered a reason for product replacement. Over time, there may be a slight color shift in the paint finish due to the continued exposure to natural and artificial light sources. We mention these characteristics because neither Diamond nor your Diamond dealer can be responsible for these conditions and variations.



*Example of front joint separation*



*Example of front joint separation*



*Example of end joint separation*

Accordingly, we ask that the following agreement be signed for Paint Finish orders.

---

I have read the foregoing and find the characteristic variations of wood and MDF with painted finish are desirable. As such, I agree not to hold Diamond and/or the Diamond dealer listed below responsible in the event that these characteristics are later found by me to be less desirable than I had expected.

\_\_\_\_\_

Customer Signature

\_\_\_\_\_

Dealer Signature

\_\_\_\_\_

Customer Name (please print)

\_\_\_\_\_

Dealer Name (please print)

\_\_\_\_\_

Dealer Purchase Order Number

# Diamond<sup>®</sup>

DISTINCTION™ SERIES

Dear Diamond Customer,

Congratulations on your selection of Diamond cabinetry in Rustic Alder. Because of its unique characteristics Rustic Alder is quite different from other wood types you may be familiar with. Your satisfaction is important to Diamond, and we want you to fully understand the characteristics that make Rustic Alder so distinctive.

It is important to realize that the beauty of wood cabinetry comes from the natural qualities of wood itself. Rustic Alder is characterized by its light brown and reddish undertones and may contain a variety of pin holes, open and closed knots of various sizes and colors, small cracks, bird pecks, mineral streaks, and grain variation. Some knots may have small holes through the panel. Larger holes will not be filled. In addition, the wood will contain color difference caused by variations in minerals found in the soil, creating visible mineral tracks. However, those characteristics that might compromise the structural integrity of the door will not be included.

Sound Closed Knot (not moveable) – Expected in Rustic Alder up to approximately 3” diameter.

Sound Knot with Cracks – Expect sound knots with open cracks up to approximately 1” in length.

Open Knot (through door) – Expected in Rustic Alder with open area up to approximately 3/4” diameter.

Note: 3/4” diameter is about the size of a penny. Holes created by open knots pass completely through the door and are desirable for this rustic look.

Unsound Knot (moveable core) – Not to be expected.

Knot Cluster (cluster of tight sound knots) – To be expected in Rustic Alder.

Worm Holes/Pin Holes (can go through door) – Can be expected on Rustic Alder up to approximately 1/4” diameter.

Worm Tracks – Can be expected on Rustic Alder in sizes up to approximately 1/8” wide by 8” long.

Rustic Alder as described is featured for doors, drawer fronts, and selected mouldings. Other areas of the product will utilize standard hard Alder. Customers should expect a much lower occurrence of rustic characteristics in these other areas. Also, the natural characteristics mentioned occur randomly in Rustic Alder. All doors, drawer fronts, and selected mouldings will contain some combination of the common Rustic Alder markings; however, it will be uncommon to find all markings on any single piece.

The natural characteristics of wood described above and variations in grain patterns and color are not considered reasons for product replacement. We mention these characteristics because neither Diamond nor your Diamond dealer can be responsible for these conditions and variations.

Accordingly, we ask that the following agreement be signed for Rustic Alder orders.

---

I have read the foregoing and find the characteristic variations of wood with Rustic Alder are desirable.

As such, I agree not to hold Diamond and/or the Diamond dealer listed below responsible in the event that these characteristics are later found by me to be less desirable than I had expected.

---

Customer Signature

---

Dealer Signature

---

Customer Name (please print)

---

Dealer Name (please print)

---

Dealer Purchase Order Number

Code	Page Number
1TWT	311
2DB	229
2DB..DR	231
2DB..FD	229
2DB..PDO	230
2DB..RT	230
2DB..RTPDO	231
2DB..WD	231
3CDB	226
3DB	232
3DB..KCUP	233
3DB..UD	256
3DB..WD	234
3DB..WTCD	233
3DBB	232
3DBBDD	235
3DBDD	234
3TWT	312
4DB	235
4DB..CIW	236
4DB..KCUP	237
4DB..WTCD	236
4TWT	313
4VDB	325
ABFOOT	403
ACAM	381
ACO	389
ACOVLY	389
ACS	46, 210
ACSF	211
ACSFb	211
ADDTK	52
ALF	57
ANGLHEATSHIELD	421
ANGLHSHIELDSS	421
APC	38
AUTHL, AUTHR	41
AV	388
B	176-256
B..CIA	228
B..COA	227
B..CIW	178
B..CWP	196
B..DR	245
B..FH	180, 182
B..FHMIXSC	199
B..FHRT	189
B..FHRTLO	193
B..FSCO	195
B..KCUP	179
B..KCUPRT	192
B..PS	194
B..RT	188
B..RTCIW	191
B..RTLO	193
B..RTUD	254-254
B..RTWTCd	192
B..TDRO	198
B..UD	253
B..WTCD	178
BARLEG	391
BATTLI	414
BBCPO	244
BBM	383
BBMSC	384
BBMSH	384
BBMSW	384
BBMWD	246
BBTP	239
BC	215
BC..PO	216
BCF	354-358
BCFW	216
BCFW..CPO	217
BCFW..PO	217
BCFW..SP	218
BCOPP	243
BCP	249
BCP..FH	249
BEAS	183

Code	Page Number
BEC	228
BED	374
BEP	368
BEP..AEL, AER	372
BEP..VG	374
BEPP	371
BEPS	365
BER	221
BERAS	220
BF	257
BFPC	390
BFRC	390
BKSOCKET	428
BLOWER	164
BLS	219
BLS..DR	218
BLSBEP	369
BLVDF	354
BMC	245
BMW	248
BMW..RT	248
BMW..UD	256
BMWd	247
BMWd..DD	247
BO	246
BOC	250
BOD	251
BP	366
BP..CRSGR	367
BP..VG	367
BPM	381
BPP	243
BPPP	194
BPS	417
BPT	177
BPT..FH	180
BPT..WB	238
BPT..WBFH	239
BQRES	250
BRAIDM	380
BRDB	225
BRKOFFSCREW	430
BRMCLP	417
BSC30PR, R, RP, RS, SR	184
BSC36PRP, PRS, SRP, SRS	186
BSCG	185, 187
BSD	241
BTC	227
BUMPERPADS	430
BUPP	243
BUPPKB	244
BV2SC30PR, RP, RS, SR	185
BV2SC36PRP, PRS, SRP, SRS	187
BWB	237
BWB..FH	238
BWBFLID, BWBLID	417
BWC	241
CABL	415
CABLRIG	415
CABMAT	417
CABMATV	417
CAPM	385
CBO	43
CCM	381
CCO	43
CD	144
CF	349
CFNTO	56
CFP	43
CFRMO	56
CG, CG..BTM, CG..TOP	58
CIW	418
CLTCROWN	376
CMAT	48
CND	43
CNTYSB	212
CNTYSB..CM	212
CNTYSB..SA	213
CONNFLX	415
CONVERSION	165

Code	Page Number
CORBELART9	408
CORBELCELT	408
CORBELCOVE	409
CORBELCRBN	413
CORBELMIS6	409
CORBELMIS9	409
CORBELOWD5	410
CORBELSCR6	410
CORBELSCR9	410
CORBELTRSS	413
COTCROWN	376
COVECROWN	376
CPE	381
CS	210
CT	143
CTDK	424
CUDD	418
DAB..FS	219
DAB..SLS	219
DAPNL	362
DB	228-236
DCM	386
DDFD	308
DDO	306
DDR	307
DER	309
DFD	307
DFFSPC	39
DFRSPC	39
DFSLB	39
DGK	428
DIMM	415
DLEMISSION	397
DOOR	360
DOORSLAB	361
DPSRR	40
DRT	49, 426
DRWPWR	50, 422
DRWSEC	48
DRWTK	55
DW	122-124
DW..D	124
DW..DS	126
DW..P	128
DW..S	123
DW..T	124
DW..TS	126
DWB..FH	308
EDGEBAND	419
EGD	380
ENDRIG	415
ENGBARCOLUMN	393
ENGISLCOLUMN	393
ER	129
ES	419
ET	49
EXBKL, EXBKR	45
EXL, EXR	46
EZORG	423
F	349
F..R	349
FALSEPNCLIP50	428
FB	41
FBF	354
FD	48, 310
FDWB	311
FFDL, FFDR	41
FFP	390
FFRC	390
FIC	242
FICNT	242
FLEX	414
FOLCROWN	376
FOOTMETAL	413
FPEB	41
FR..UD	257
FRNLG	404
FS	156
FTK, FTK..FNT.P, FTK.P	52
FTKAV, FTKAV..FNT.P, FTKAV.P	52

Code	Page Number
FTKfV, FTKfV..FNT.P, FTKfV.P	52
FV	388
GLAZEPEN	429
HINGE	416
HINGERESCLIP	429
HINGESHIM	430
HL	175
HM	173-174
HP..21	171
HPP..21	172
HS	175
ICM	387
ID	44
INSCROWN	376
INSERTCELT	380
INSTALLSCR, INSTALLSCREWS	430
INFRM	47
IR	415
ISLLEG	396
I3SPRING	407
JACANFOOT	404
JACANINSERTM	380
JACANTHUSLEG	391
JBAROQUELEG	392
JBRACKETART	411
JBUFFETLEG	392
JCELOVLY	389
JCORBELARTO	411
JCORBELCOS7	408
JCORBELCOS13	409
JCORBELCOS13D	409
JCORBELCRAFTO	411
JCORBELOWD4	410
JCORBELOWD7	410
JCORBELSHKR	411
JCORBELTRADO	412
JCOSFOOT	404
JCOSMOLEG	392
JCRAFTFOOT	404
JENGCNTYLEG	392
JESTATELEG	394
JESTATELEGS	393
JESTATELEGSS	393
JFLUTELEG	394
JFLUTELEGS	394
JFLUTELEGSS	394
JFRNCNTYFOOT	404
JFRNCNTYLEG	395
JGSK	420
JINSERTLRC	386
JINSERTLRT	386
JLRINSACAN	386
JLRINSCFLT	386
JLRINSMIS	386
JLRINSWEAVE	386
JMADEFoot	404
JMADFoot	404
JMETROFOOT	405
JMISINSERTM	380
JPWRPOD	422
JQUANNELEG	397
JRCPV	388
JRDLEG	398
JROPELEG	399
JROPELEGS	399
JROPELEGSS	399
JRPV	388
JSOC	412
JSPLEGS	400
JSPLEGSS	400
JSPLEGT	401
JSQBARLEG	402
JSQBARLEG3S	402
JSQFOOT	405
JSQFOOTS	405
JSQISLLEG	401
JSQISLLEG3S	401
JSRC	412
JTILEACAN	391
JTILEMISSION	391

Code	Page Number
JTULILEG	402
JURNLEG	403
JWEAVEFOOT	405
JWEAVEINSERTM	381
JWEAVELEG	398
JWHCA	162
JWHCONSTR	159
JWHCS	163
JWHIA	163
JWHIS	163
JWHL	160
JWHSHIPCH	161
JWHSHIPSTR	160
JWHSHIPSTRCB	160
JWHSHIPT	161
JWHSHIPTCB	161
KCUP	419
KNOBH	416
LB	385
LBRM	382
LC	341
LCHAMPERLNR	421
LCRH	342
LEADFLX	415
LEADRIC	415
LGCORBEL	408
LGSQFOOT	405
LIDSTAY, LIDSTAYHD	430
LIFOOT	405
LO, LO24DP	421
LOSC	387
LRM	385
LSACROWN	377
LSHAKER	377
LSP	226
LT	342
LTI	49
MC	346
MCT16HDW/WCATCH	430
MD, MD.BTM, MD.TOP	59
MDENTIL	380
METBARCOLUMN	396
METISLCOLUMN	397
MFO	40
MIP	42
MIXKITFHSC	417
MSACROWN	377
MTCROWN	377
MTUK	429
MV	340
MW	139
OC..UD	257
OC135	387
OCD, OCD..DD, OCD..WD, OCD..WDE	287-292
OCINSTALLKIT	422
OCM	387
OCS, OCS..DD, OCS..WD	282-286
OGEEM	382
OL	350
OL..MFO	350
OMC, OMC..DD, OMC..WD	294-298
P	56
PDM	430
PDO, PDOPOSTS	422
PE	38
PFALSEPNLCLIP50	428
PFINBTMB	45
PLBLOCK	406
PPP	422
PRB	309
PRMD	61
PTOWB	50
PTU	275
PTUP	276
PTUS	274
PUCK	414
PULLH	413, 416
PWT	281
PY	279

Code	Page Number
Q4ZONECON	415
QDIMREC	415
QRM	387
QUARTCOLOR	429
RD	44
RDLEG	397
RECTKALL	54
RECTKBK	54
RECTKL	54
RECTKR	54
RESCLIPOQR	429
RETCLIP.BAG	430
RIGID	414
ROSETTCELL	390
ROSETTEMIS	389
ROSETTESCR	389
RPM	380
RT	49, 426
RTBKXSXP	428
RVWS	255
S96	350
SACROWN	377
SB	200-203
SB..CDY	201
SB..CM	201
SB..D	209
SB..S	206
SB..SCDY	207
SB..SCM	206
SB..ST	203
SB..STCDY	204
SB..STCM	204
SB..STS	207
SB..STSCDY	208
SB..STSCM	208
SB..STUD	255
SB..UD	254
SBC	214
SBCADDY	422
SBE	382
SBM	382
SBP	382
SBS	410
SCM	378
SCPDRW	40
SFB	209
SFM	379
SHELFBRKTSN	413
SHELFPEGS, SHELFPEGSCTR	430
SHKRCRM	377
SHLFDP	423
SHM	387
SHMD	60
SK	420
SLS	222, 224
SLS..UD	256
SLSCR	223, 225
SLSW	223
SM	381
SMCORBEL	408
SMCOVECROWN	378
SMLR	385
SPACERBLK	428
SPD	423
SPLG	401
SPTRINGEND	407
SPTRINGREED	407
SPTRINGROPE	407
SPTRINGSPPOOL	407
SRCH	423
SSC	429
SSM	382
SSS	222
ST	142
STAND	414
STDW	127
STR	423
STR8	379
STRS	379
STRTHEATSHIELD	421

Code	Page Number
STRTHSHIELDSS	421
STW	114
STWEC	133
STWEC..D	134
STWTC	138
SV	388
SWCRM	378
SWLCRM	378
SWTCRM	379
SWVCRM	379
TABLETHLDR	423
TAPLG	406
TB	384
TB8UD	258
TBC	302-303
TBCD	304-305
TBEM	383
TBMWB	293
TBP	383
TCM	381
TD	51, 198
TD..FH	199
TDKIT	424
TDRO	424
TED	375
TEP, TEP..AEL, TEP..AER	369, 373
TEP..VG	374
TEP	373
TEPS	365
TF	257, 349
TTC	385
TKP	54
TKTLFOOT	406
TLFOOT	406
TOEKICKVAC	423
TOT	423
TOTSS	50, 424
TOTSSS	50, 424
TOUCHLATCH	413
TPP	276
TRAYSHELF	157
TROSETTE	389
TSTM	383
TUK	429
TV	348
TVHDW/WCATCH	430
TVRAV, TVRFV, TVRVV	47
TWH	164
TWHBLOWER	165
U	259-264
U..RT	265-267
UCD	313, 340
UEAS	268-271
UOC	272
UOCDZ	273
UPM	383
US	278
US..PP	278
V	314-316
VACSF	339
VACSFV	339
VB	322
VBEP	370
VBH	341
VBWB	326
VCRR	425
VDB	324
VDL	373
VDLUD	258
VER	323
VFR	385
VGPO	328
VH..FH	341
VM	347
VMP	347
VP	328
VS3D	335
VSF	317-318
VSF.....U	319
VSF.....WB	319

Code	Page Number
VSD	329-336, 338
VSD..FP	337, 338
VSSB.....ST	320
VSSB.....STWB	320
VTK	55
VU	343
VV	388
VWB	326
VWH	343
VWM	346
VWS	255
VWTB	345
W	85-108, 155, 346
W..BC	299
W..CIA	132
W..COA	131
W..PO	94, 98 101
W..SHLFPD	149
W..SPD	149
W2D	109, 111
W3D	112
WAGD	142
WAGVLD	143
WAIN	359
WB	182
WBPCO	144
WBPCOKCUP	146, 421
WBMW	140
WC	117-120
WCD	152
WCS	157
WCT	385
WEAS	108
WEC	133
WED	375
WEP..VG	374
WEP	374
WEPS	366
WFB	300
WGH	425
WHA	158
WHC	159
WHCA	162
WHCS	162
WHS	159
WLI	42
WMC	158
WMF	382
WNR	154
WO	155
WOC	151-152
WQRES	135-136
WS	157
WSC	154
WSCRIBE	383
WSD	156
WSK	425
WSP	148
WSR	150
WTC	137
WTCO	418
WTH	86-97
WVL	92-97



## **OUR COMMITMENT TO CHANNEL PARTNERS, DESIGNERS AND CONSUMERS**

Diamond's Express Response™ program is designed to expedite orders when customers need product faster than normal lead times to correct problems with an existing order.

Below is an overview of the program and what you can expect from Diamond's commitment to superior service.

### **GUIDELINES**

- Order must be associated with a previous order number.
- All orders received by 12 NOON E.T. Monday-Friday will be automatically scheduled for Express Response that same day. Orders received after the cutoff time will be processed on the next business day.
- Lead time calculation is based on receipt of a clean order on a credit-worthy account. Clean orders are orders in which all information is provided and accurate.
- There are no cancellations or returns once order is received.
- Due to the special nature of Special Orders and Appliance Panels, they are excluded from the Express Response program and will be processed as a standard lead time order.
- Express Response is available within the continental United States. Should Alaska, Hawaii or international shipments be required, customer service representatives are ready to assist by providing shipping information and determining lead times.

### **LEAD TIMES**

#### **12 WORKING DAYS OR LESS FROM ORDER TO DELIVERY** (channel partner or home delivery agent):

- Items shipped via LTL (via SuperPAC™) or truckload.
- Includes all catalog items except those that can be expedited through the 5-day program listed below.

#### **5 WORKING DAYS FROM ORDER TO DELIVERY:**

- Qualified items are designated in the Pricing/Specification Guide with an icon 
- Items will ship via parcel ground.
  - Lead time calculation allows for 2 days parcel ground shipping time. Some geographic areas may require additional shipping time.
- For orders containing both 12 day and 5 day items, the longer lead time applies.

QUESTIONS? If you have questions that aren't answered here, contact your Customer Service team.







Price Point Order

1	Ridgefield Oak	10	Liberty Maple
2	Ridgefield Maple	10	Sullivan Maple
3	Monterey Oak	11	Bailey Cherry
4	Cullen Maple	11	Crandall Cherry
4	Monterey Maple	12	Caldera Maple
4	Perkins Oak	12	Caldera MDF ◇
4	Shiloh Alder	12	Julien Maple
4	Shiloh Maple	12	Montgomery Cherry
4	Shiloh Rustic Alder	12	Sumner Oak
5	Hanlon Maple	12	Wells Maple
5	Perkins Hickory	13	Anden Maple
5	Perkins Maple	13	Evans Cherry
6	Catalina Thermofoil	13	Liberty Cherry
6	Crandall Oak	13	Sullivan Cherry
6	Ridgefield Cherry	14	Breman Cherry
7	Cullen Cherry	14	Leeton Cherry
7	Monterey Cherry	14	Trystan Maple ◇
7	Shiloh Cherry	14	Trystan MDF
8	Bailey Maple	15	Caldera Cherry
8	Breman Oak	15	Julien Cherry
8	Crandall Alder	15	Rothshire Maple
8	Crandall Hickory	15	Selena Alder
8	Crandall Maple	15	Selena Maple
8	Crandall Rustic Alder	15	Sumner Alder
8	Hanlon Cherry	15	Sumner Maple
8	Perkins Cherry	15	Sumner Rustic Alder
9	Evans Oak	16	Davis Maple
9	Montgomery Alder	16	Graniti Laminate
9	Montgomery Hickory	16	Rothshire Cherry
9	Montgomery Maple	16	Tranter Laminate
9	Montgomery MDF ◇	16	Trystan Cherry
9	Montgomery Rustic Alder	16	Wells Cherry
10	Breman Alder	16	Wixom Laminate
10	Breman Maple	16	Worthen PureStyle
10	Breman MDF ◇	17	LaGrange Maple
10	Breman Rustic Alder	17	Laureldale Maple
10	Carson Alder	17	Selena Cherry
10	Carson Rustic Alder	17	Sumner Cherry
10	Evans Hickory	18	Davis Cherry
10	Evans Maple	18	LaGrange Cherry
10	Leeton Maple	18	Laureldale Cherry

Alphabetical Order

13	Anden Maple	10	Liberty Maple
11	Bailey Cherry	7	Monterey Cherry
8	Bailey Maple	4	Monterey Maple
10	Breman Alder	3	Monterey Oak
14	Breman Cherry	9	Montgomery Alder
10	Breman Maple	12	Montgomery Cherry
10	Breman MDF ◇	9	Montgomery Hickory
8	Breman Oak	9	Montgomery Maple
10	Breman Rustic Alder	9	Montgomery MDF ◇
15	Caldera Cherry	9	Montgomery Rustic Alder
12	Caldera Maple	8	Perkins Cherry
12	Caldera MDF ◇	5	Perkins Hickory
10	Carson Alder	5	Perkins Maple
10	Carson Rustic Alder	4	Perkins Oak
6	Catalina Thermofoil	6	Ridgefield Cherry
8	Crandall Alder	2	Ridgefield Maple
11	Crandall Cherry	1	Ridgefield Oak
8	Crandall Hickory	16	Rothshire Cherry
8	Crandall Maple	15	Rothshire Maple
6	Crandall Oak	15	Selena Alder
8	Crandall Rustic Alder	17	Selena Cherry
7	Cullen Cherry	15	Selena Maple
4	Cullen Maple	4	Shiloh Alder
18	Davis Cherry	7	Shiloh Cherry
16	Davis Maple	4	Shiloh Maple
13	Evans Cherry	4	Shiloh Rustic Alder
10	Evans Hickory	13	Sullivan Cherry
10	Evans Maple	10	Sullivan Maple
9	Evans Oak	15	Sumner Alder
16	Graniti Laminate	17	Sumner Cherry
8	Hanlon Cherry	15	Sumner Maple
5	Hanlon Maple	12	Sumner Oak
15	Julien Cherry	15	Sumner Rustic Alder
12	Julien Maple	16	Tranter Laminate
18	LaGrange Cherry	16	Trystan Cherry
17	LaGrange Maple	14	Trystan Maple
18	Laureldale Cherry	14	Trystan MDF ◇
17	Laureldale Maple	16	Wells Cherry
14	Leeton Cherry	12	Wells Maple
10	Leeton Maple	16	Wixom Laminate
13	Liberty Cherry	16	Worthen PureStyle

# Diamond®

Make your mark.™

- ◆ EDGE™ SERIES
- ◆ DISTINCTION™ SERIES
- ◆ VIBE™ SERIES

Styles, product availability and construction may vary slightly from those shown in this book due to material availability and/or design evolution. Specifications are subject to change without notice. Customer service is available if your design requires verification of product availability and specifications.

Product photography and illustrations have been reproduced as accurately as printing technologies permit. To ensure highest satisfaction, we strongly recommend you view an actual sample for best color, wood grain and finish representation.

Diamond® is a certified brand in the Kitchen Cabinet Manufacturers Association (KCMA) Environmental Stewardship Program. The program recognizes companies that demonstrate an ongoing commitment to environmental practices and sustainability.

## Diamond® has a Limited Lifetime Warranty.

For terms and conditions, please visit: <https://www.diamondcabinets.com/warranty>

Cabinet Care and Cleaning Instructions: <https://www.masterbrand.com/care-and-cleaning>

**Front cover image:** MONTGOMERY Maple Egret and Grizzly **Back cover flip-out image:** TRANTER Textured Laminate Arctic



Part of the  
MasterBrand®  
Family

[diamondcabinets.com](https://www.diamondcabinets.com)  
#DiamondCabinets  
© 2019 MasterBrand Cabinets, Inc.

## Customer Service

Hours: Mon - Fri, 7:30 AM - 8:00 PM EST

Phone: (800) 730-0171 Fax: (877) 333-7122

Please reference Service Policies at [www.mbc1touch.com](http://www.mbc1touch.com)

Designer ID #: \_\_\_\_\_

Customer Account #: \_\_\_\_\_

Sales Rep: \_\_\_\_\_